

**REVISED FINAL REPORT**

**CRADLE-TO-GATE LIFE CYCLE INVENTORY OF NINE PLASTIC RESINS  
AND FOUR POLYURETHANE PRECURSORS**

**Prepared for**

**THE PLASTICS DIVISION OF  
THE AMERICAN CHEMISTRY COUNCIL**

**by**

**FRANKLIN ASSOCIATES,  
A DIVISION OF EASTERN RESEARCH GROUP, INC.  
Prairie Village, Kansas**

**August, 2011**

## PREFACE

This cradle-to-resin LCI study was conducted for the Plastics Division of the American Chemistry Council (ACC). Mike Levy was the project coordinator for the Plastics Division of the ACC. The report was made possible through the cooperation of ACC member companies and non-member companies who provided data on the production of nine plastic resins, four polyurethane precursors, and on a number of intermediate chemicals. This report is an update to the final report dated July, 2010. Many changes were made due to the intense scrutiny of all data as it was provided to the NREL U.S. LCI Database. Some were small changes in one or two emissions for a dataset; while some were larger changes which affected the total dataset of some of the plastics. A list of differences between this report and the previous report can be found in the Addendum.

Eastern Research Group, Franklin Associates Division, carried out the work as an independent contractor for this project. Melissa Huff was Project Manager. Beverly Sauer provided technical and editorial review. Significant contributions were made by Rebe Feraldi, Anne Marie Molen, Sarah Cashman, James Littlefield, and Lori Snook. William E. Franklin served as original Principal in Charge. Robert G. Hunt provided technical guidance.

Franklin Associates and the Plastics Division of the American Chemistry Council are grateful to all of the companies and associations that participated in the LCI data collection process. These companies include Arch Chemicals, Inc.; TOTAL Petrochemicals USA, Inc.; BASF Corporation; Bayer Material Science, LLC; Ineos Olefins; Innovene USA; Huntsman International LLC; Chevron Phillips Chemical Company (CP Chem); Dow Chemical Company; Eastman Chemical; ExxonMobil Chemical Company; Formosa Plastics Corporation U.S.A.; Georgia Gulf Chemicals and Vinyls, LLC; Rubicon LLC; Lanxess Corporation; NOVA Chemicals Corporation; Occidental Chemical Corporation; Shintech, Inc.; and Wellman, Inc. We would also like to thank Neeva-Gayle Candelori of the ACC Center for the Polyurethanes Industry, Allen Blakey of The Vinyl Institute, and Fred Edgecombe of the Canadian Plastics Industry Association.

Thank you to all those who reviewed the draft appendices/report of the 2010 analysis. Finally, we thank David Russell, Fred Marechal, and Aafko Schanssema of PlasticsEurope and Ian Boustead of Boustead Consulting for reviewing the plastics/precursor energy data in 2006-7.

Comparisons between plastic resins should not be made on the basis of cradle-to-resin/precursor results, as the ISO 14040 series of standards require that comparisons of product systems must be made on the basis of equivalent function, and functional equivalence cannot be established without including fabrication of the resin or precursor into a functional product.

August, 2011

# Table of Contents

<b>EXECUTIVE SUMMARY .....</b>	<b>ES-1</b>
<b>CHAPTER 1 – STUDY APPROACH AND METHODOLOGY .....</b>	<b>1-1</b>
OVERVIEW .....	1-1
Study Goal and Intended Audience.....	1-2
U.S. Life Cycle Database Project.....	1-2
Study Scope and Boundaries.....	1-3
LIFE CYCLE INVENTORY METHODOLOGY .....	1-4
Material Requirements .....	1-5
Energy Requirements.....	1-6
Environmental Emissions .....	1-7
LCI PRACTITIONER METHODOLOGY VARIATION .....	1-9
Coproduct Credit.....	1-9
Energy of Material Resource .....	1-11
DATA .....	1-14
Process Data.....	1-14
Fuel Data.....	1-16
Data Quality Goals for This Study.....	1-17
Data Accuracy.....	1-18
ISO Data Quality Requirements and Use of Study .....	1-19
CRITICAL/PEER REVIEW .....	1-19
METHODOLOGY ISSUES .....	1-20
Raw Material Use for Internal Energy .....	1-20
Recovered Energy Exported from System Boundaries .....	1-20
Precombustion Energy and Emissions .....	1-21
Electricity Grid Fuel Profile.....	1-21
Electricity/Heat Cogeneration.....	1-21
METHODOLOGICAL DECISIONS .....	1-23
Geographic Scope .....	1-23
System Components Not Included.....	1-23
<b>CHAPTER 2 – CRADLE-TO-RESIN LIFE CYCLE INVENTORY RESULTS FOR HDPE RESIN.....</b>	<b>2-1</b>
DESCRIPTION OF TABLES .....	2-2
<b>CHAPTER 3 – CRADLE-TO-RESIN LIFE CYCLE INVENTORY RESULTS FOR LDPE RESIN.....</b>	<b>3-1</b>
DESCRIPTION OF TABLES .....	3-2
<b>CHAPTER 4 – CRADLE-TO-RESIN LIFE CYCLE INVENTORY RESULTS FOR LLDPE RESIN.....</b>	<b>4-1</b>
DESCRIPTION OF TABLES .....	4-2
<b>CHAPTER 5 – CRADLE-TO-RESIN LIFE CYCLE INVENTORY RESULTS FOR PP RESIN ...</b>	<b>5-1</b>
DESCRIPTION OF TABLES .....	5-2
<b>CHAPTER 6 – CRADLE-TO-RESIN LIFE CYCLE INVENTORY RESULTS FOR PET RESIN.....</b>	<b>6-1</b>
DESCRIPTION OF TABLES .....	6-2

<b>CHAPTER 7 – CRADLE-TO-RESIN LIFE CYCLE INVENTORY RESULTS FOR GPPS RESIN.....</b>	<b>7-1</b>
DESCRIPTION OF TABLES .....	7-3
<b>CHAPTER 8 – CRADLE-TO-RESIN LIFE CYCLE INVENTORY RESULTS FOR HIPS RESIN.....</b>	<b>8-1</b>
DESCRIPTION OF TABLES .....	8-2
<b>CHAPTER 9 – CRADLE-TO-RESIN LIFE CYCLE INVENTORY RESULTS FOR PVC RESIN.....</b>	<b>9-1</b>
DESCRIPTION OF TABLES .....	9-3
<b>CHAPTER 10 – CRADLE-TO-RESIN LIFE CYCLE INVENTORY RESULTS FOR ABS RESIN.....</b>	<b>10-1</b>
DESCRIPTION OF TABLES .....	10-3
<b>CHAPTER 11 – CRADLE-TO-PRECURSOR LIFE CYCLE INVENTORY RESULTS FOR POLYETHER POLYOL USED FOR RIGID FOAM POLYURETHANE.....</b>	<b>11-1</b>
DESCRIPTION OF TABLES .....	11-2
<b>CHAPTER 12 – CRADLE-TO-PRECURSOR LIFE CYCLE INVENTORY RESULTS FOR POLYETHER POLYOL USED FOR FLEXIBLE FOAM POLYURETHANE.....</b>	<b>12-1</b>
DESCRIPTION OF TABLES .....	12-2
<b>CHAPTER 13 – CRADLE-TO-PRECURSOR LIFE CYCLE INVENTORY RESULTS FOR MDI.....</b>	<b>13-1</b>
DESCRIPTION OF TABLES .....	13-3
<b>CHAPTER 14 – CRADLE-TO-PRECURSOR LIFE CYCLE INVENTORY RESULTS FOR TDI.....</b>	<b>14-1</b>
DESCRIPTION OF TABLES .....	14-2
<b>ADDENDUM – DIFFERENCES BETWEEN THE U.S. LCI PLASTICS DATABASE AND THE PLASTICSEUROPE ECO-PROFILES DATABASE .....</b>	<b>AD-1</b>
INTRODUCTION .....	AD-1
OVERVIEW OF COMPARISON OF PLASTICS AND PRECURSOR ENERGY AND GREENHOUSE GAS RESULTS .....	AD-2
Energy Comparison .....	AD-2
Greenhouse Gas Comparison.....	AD-4
DATA SOURCES .....	AD-5
METHODOLOGICAL DIFFERENCES .....	AD-7
CONCLUSION .....	AD-11
DIFFERENCES BETWEEN 2010 INTERMEDIATE DATA AND 2011 FINAL DATA .....	AD-11
<b>BIBLIOGRAPHY .....</b>	<b>B-1</b>
DATA ON THE PRODUCTION AND COMBUSTION OF FUELS FOR PROCESS AND TRANSPORTATION ENERGY (INCLUDING ELECTRICITY GENERATION).....	B-1
PRODUCTION OF HDPE RESIN.....	B-8
PRODUCTION OF LDPE RESIN .....	B-11
PRODUCTION OF LLDPE RESIN.....	B-11
PRODUCTION OF PP RESIN .....	B-11
PRODUCTION OF PET RESIN.....	B-11
PRODUCTION OF GPPS RESIN .....	B-12
PRODUCTION OF HIPS RESIN .....	B-13

PRODUCTION OF PVC RESIN .....	B-13
PRODUCTION OF ABS RESIN .....	B-14
PRODUCTION OF POLYETHER POLYOL FOR RIGID FOAM POLYURETHANE.....	B-14
PRODUCTION OF POLYETHER POLYOL FOR FLEXIBLE FOAM POLYURETHANE .....	B-15
PRODUCTION OF METHYLENE DIPHENYLENE DIISOCYANATE (MDI).....	B-16
PRODUCTION OF TOLUENE DIISOCYANATE (TDI) .....	B-17
<b>GLOSSARY – TERMS USED IN THE LCI REPORT AND APPENDICES .....</b>	<b>G-1</b>

### List of Tables

Table 1-1	Higher Heating Values for the Plastic Resins Analyzed .....	1-13
Table 2-1	Energy by Category for the Production of HDPE Resin .....	2-2
Table 2-2	Energy Profile for the Production of HDPE Resin.....	2-3
Table 2-3	Solid Wastes by Weight for the Production of HDPE Resin .....	2-4
Table 2-4	Atmospheric Emissions for the Production of HDPE Resin .....	2-5
Table 2-5	Greenhouse Gas Summary for the Production of HDPE Resin .....	2-7
Table 2-6	Waterborne Emissions for the Production of HDPE Resin .....	2-8
Table 3-1	Energy by Category for the Production of LDPE Resin .....	3-2
Table 3-2	Energy Profile for the Production of LDPE Resin .....	3-3
Table 3-3	Solid Wastes by Weight for the Production of LDPE Resin.....	3-4
Table 3-4	Atmospheric Emissions for the Production of LDPE Resin .....	3-5
Table 3-5	Greenhouse Gas Summary for the Production of LDPE Resin.....	3-7
Table 3-6	Waterborne Emissions for the Production of LDPE Resin .....	3-8
Table 4-1	Energy by Category for the Production of LLDPE Resin.....	4-2
Table 4-2	Energy Profile for the Production of LLDPE Resin.....	4-3
Table 4-3	Solid Wastes by Weight for the Production of LLDPE Resin .....	4-4
Table 4-4	Atmospheric Emissions for the Production of LLDPE Resin .....	4-5
Table 4-5	Greenhouse Gas Summary for the Production of LLDPE Resin .....	4-7
Table 4-6	Waterborne Emissions for the Production of LLDPE Resin.....	4-8
Table 5-1	Energy by Category for the Production of PP Resin .....	5-2
Table 5-2	Energy Profile for the Production of PP Resin.....	5-3
Table 5-3	Solid Wastes by Weight for the Production of PP Resin .....	5-4
Table 5-4	Atmospheric Emissions for the Production of PP Resin .....	5-5
Table 5-5	Greenhouse Gas Summary for the Production of PP Resin .....	5-7
Table 5-6	Waterborne Emissions for the Production of PP Resin.....	5-8
Table 6-1	Energy by Category for the Production of PET Resin .....	6-3
Table 6-2	Energy Profile for the Production of PET Resin.....	6-4
Table 6-3	Solid Wastes by Weight for the Production of PET Resin.....	6-5
Table 6-4	Atmospheric Emissions for the Production of PET Resin .....	6-6
Table 6-5	Greenhouse Gas Summary for the Production of PET Resin.....	6-8
Table 6-6	Waterborne Emissions for the Production of PET Resin .....	6-9
Table 7-1	Energy by Category for the Production of GPPS Resin.....	7-3
Table 7-2	Energy Profile for the Production of GPPS Resin .....	7-4
Table 7-3	Solid Wastes by Weight for the Production of GPPS Resin .....	7-5
Table 7-4	Atmospheric Emissions for the Production of GPPS Resin .....	7-6
Table 7-5	Greenhouse Gas Summary for the Production of GPPS Resin .....	7-8
Table 7-6	Waterborne Emissions for the Production of GPPS Resin.....	7-9

Table 8-1	Energy by Category for the Production of HIPS Resin.....	8-3
Table 8-2	Energy Profile for the Production of HIPS Resin .....	8-4
Table 8-3	Solid Wastes by Weight for the Production of HIPS Resin .....	8-5
Table 8-4	Atmospheric Emissions for the Production of HIPS Resin.....	8-6
Table 8-5	Greenhouse Gas Summary for the Production of HIPS Resin .....	8-8
Table 8-6	Waterborne Emissions for the Production of HIPS Resin.....	8-9
Table 9-1	Energy by Category for the Production of PVC Resin .....	9-3
Table 9-2	Energy Profile for the Production of PVC Resin .....	9-4
Table 9-3	Solid Wastes by Weight for the Production of PVC Resin .....	9-5
Table 9-4	Atmospheric Emissions for the Production of PVC Resin.....	9-6
Table 9-5	Greenhouse Gas Summary for the Production of PVC Resin.....	9-8
Table 9-6	Waterborne Emissions for the Production of PVC Resin .....	9-9
Table 10-1	Energy by Category for the Production of ABS Resin .....	10-3
Table 10-2	Energy Profile for the Production of ABS Resin .....	10-4
Table 10-3	Solid Wastes by Weight for the Production of ABS Resin .....	10-5
Table 10-4	Atmospheric Emissions for the Production of ABS Resin.....	10-6
Table 10-5	Greenhouse Gas Summary for the Production of ABS Resin .....	10-8
Table 10-6	Waterborne Emissions for the Production of ABS Resin .....	10-9
Table 11-1	Energy by Category for the Production of Polyether Polyol for Rigid Foam Polyurethane .....	11-3
Table 11-2	Energy Profile for the Production of Polyether Polyol for Rigid Foam Polyurethane .....	11-4
Table 11-3	Solid Wastes by Weight for the Production of Polyether Polyol for Rigid Foam Polyurethane .....	11-5
Table 11-4	Atmospheric Emissions for the Production of Polyether Polyol for Rigid Foam Polyurethane .....	11-6
Table 11-5	Greenhouse Gas Summary for the Production of Polyether Polyol for Rigid Foam Polyurethane .....	11-8
Table 11-6	Waterborne Emissions for the Production of Polyether Polyol for Rigid Foam Polyurethane .....	11-9
Table 12-1	Energy by Category for the Production of Polyether Polyol for Flexible Foam Polyurethane .....	12-3
Table 12-2	Energy Profile for the Production of Polyether Polyol for Flexible Foam Polyurethane .....	12-4
Table 12-3	Solid Wastes by Weight for the Production of Polyether Polyol for Flexible Foam Polyurethane .....	12-5
Table 12-4	Atmospheric Emissions for the Production of Polyether Polyol for Flexible Foam Polyurethane .....	12-6
Table 12-5	Greenhouse Gas Summary for the Production of Polyether Polyol for Flexible Foam Polyurethane .....	12-8
Table 12-6	Waterborne Emissions for the Production of Polyether Polyol for Flexible Foam Polyurethane .....	12-9
Table 13-1	Energy by Category for the Production of MDI.....	13-4
Table 13-2	Energy Profile for the Production of MDI .....	13-5
Table 13-3	Solid Wastes by Weight for the Production of MDI .....	13-6
Table 13-4	Atmospheric Emissions for the Production of MDI.....	13-7
Table 13-5	Greenhouse Gas Summary for the Production of MDI .....	13-9
Table 13-6	Waterborne Emissions for the Production of MDI .....	13-10

Table 14-1	Energy by Category for the Production of TDI.....	14-3
Table 14-2	Energy Profile for the Production of TDI .....	14-3
Table 14-3	Solid Wastes by Weight for the Production of TDI .....	14-4
Table 14-4	Atmospheric Emissions for the Production of TDI.....	14-5
Table 14-5	Greenhouse Gas Summary for the Production of TDI .....	14-7
Table 14-6	Waterborne Emissions for the Production of TDI.....	14-8
Table AD-1	Total Energy Comparison of ACC Plastics LCI Database and PlasticsEurope Plastics LCI Database .....	AD-3
Table AD-2	Energy Categories: Terminology and Definition .....	AD-4
Table AD-3	Total CO <sub>2</sub> Equivalent Comparison of ACC Plastics LCI Database and PlasticsEurope Plastics LCI Database .....	AD-5
Table AD-4	Comparison of Regional and Average Electricity Grids for North America .....	AD-11
Table AD-5	Total Energy and CO <sub>2</sub> Equivalent Comparison of 2010 and 2011 ACC Plastics LCI Database.....	AD-12

## List of Figures

Figure 1-1	General Materials Flow for “Cradle-to-Grave” Analysis of a Product System.....	1-1
Figure 1-2	“Black Box” Concept for Developing LCI Data .....	1-5
Figure 1-3	Illustration of the Energy of Material Resource Concept.....	1-12
Figure 2-1	Flow Diagram for the Manufacture of Virgin High-density Polyethylene (HDPE) Resin.....	2-1
Figure 3-1	Flow Diagram for the Manufacture of Virgin Low-density Polyethylene (LDPE) Resin .....	3-1
Figure 4-1	Flow Diagram for the Manufacture of Virgin Linear Low-density (LLDPE) Resin.....	4-1
Figure 5-1	Flow Diagram for the Manufacture of Virgin Polypropylene (PP) Resin .....	5-1
Figure 6-1	Flow Diagram for the Manufacture of Virgin Polyethylene Terephthalate (PET) Resin .....	6-1
Figure 7-1	Flow Diagram for the Production of General Purpose Polystyrene Resin .....	7-1
Figure 8-1	Flow Diagram for the Production of High-impact Polystyrene Resin .....	8-1
Figure 9-1	Flow Diagram for the Manufacture of Polyvinyl Chloride (PVC) Resin.....	9-1
Figure 10-1	Flow Diagram for the Production of Acrylonitrile-butadiene-styrene (ABS) Resin.....	10-1
Figure 11-1	Flow Diagram for the Manufacture of Polyether Polyol for Rigid Foam Polyurethane .....	11-1
Figure 12-1	Flow Diagram for the Manufacture of Polyether Polyol for Flexible Foam Polyurethane ..	12-1
Figure 13-1	Flow Diagram for the Manufacture of Methylene Diphenylene Diisocyanate (MDI) .....	13-1
Figure 14-1	Flow Diagram for the Manufacture of Toluene Diisocyanate (TDI) .....	14-2
Figure AD-1	Flow Diagram of the Use of Horizontal Averaging to Calculate Primary Average LDPE Data .....	AD-8
Figure AD-2	Flow Diagram of the Use of Vertical Averaging to Calculate Primary Average LDPE Data.....	AD-8

## EXECUTIVE SUMMARY

All manufacturing or industrial processes have both inputs and outputs. A life cycle inventory (LCI) is the phase of a life cycle assessment (LCA) involving the compilation and quantification of inputs and outputs for a given product systems throughout its life cycle.

The cradle-to-gate life cycle inventory presented in this study quantifies the total energy requirements, energy sources, atmospheric pollutants, waterborne pollutants, and solid waste resulting from the production of nine plastic resins and four polyurethane precursors produced in North America. The plastic resins studied are high-density polyethylene (HDPE), low-density polyethylene (LDPE), linear low-density polyethylene (LLDPE), polypropylene (PP), polyethylene terephthalate (PET), general-purpose polystyrene (GPPS), high-impact polystyrene (HIPS), polyvinyl chloride (PVC), and acrylonitrile-butadiene-styrene (ABS). The four polyurethane precursors studied are flexible foam polyurethane (PU) polyether polyols, rigid foam PU polyether polyols, methylene diphenylene diisocyanate (MDI), and toluene diisocyanate (TDI).

The resulting LCI database was compiled by Franklin Associates and is based on data collected specifically for this project from 17 resin/precursor manufacturers, representing more than 80 plants in North America. Supplementary data on some upstream unit processes are from the Franklin Associates database. The fuels and energy database are from the U.S. LCI database.

The goal of this study was to provide both the members of the Plastics Division of the American Chemistry Council (ACC) and the general public with the most up to date LCI data for the resins and polyurethanes precursors analyzed in this database. The database will also be publicly available at the U.S. LCI Database website (<http://www.nrel.gov/lci/>). The results of this analysis are presented in both English and Metric units for the benefit of the eventual intended audience, which may include international users.

Providing the data to the U.S. LCI Database has several important benefits for Plastics Division of ACC members. The U.S. LCI Database project is a private/public partnership, with the Department of Energy (DOE), Environmental Protection Agency (EPA), and General Services Administration (GSA) providing some funding. Industry contribution from trade associations has been in-kind data (e.g., aluminum, plastics, wood) as well as industry customer contributions of data and resources (e.g., Vehicle Recycling Partnership). Once the major materials databases are developed – plastics, aluminum, steel, wood, paper, glass – the emphasis can be placed on the transformation (fabrication) processes such as injection molding, blow molding, and the like. Major customers (building & construction, automotive, electrical and electronics) indicate the need to access this LCI data and evaluate various transformation processes to make decisions on the most sustainable processes to consider in developing manufactured products. As LCIs are conducted by multiple stakeholders in the future (Non



Governmental Agencies/NGOs; governments, universities, LCI practitioners, industry) for a number of different reasons (e.g., benchmarking for product/process improvement, future impact assessments), the U.S. LCI Database Project provides a publicly available up to date database, while affording proprietary and confidentiality protection for individual industry data submissions.

This LCI report includes the following sections, which present a discussion of the study approach and methodology and specific polymer and polyurethanes precursor results:

- Chapter 1 – Study Approach and Methodology, including overview; LCI methodology; LCI practitioner methodology variation; data description; critical/peer review; methodology issues and decisions
- Chapters 2-14 – LCI inventory results for HDPE, LDPE, LLDPE, PP, PET, GPPS, HIPS, PVC, ABS, Rigid Foam PU Polyether Polyols, Flexible Foam PU Polyether Polyols, MDI, and TDI respectively
- Addendum – Differences between the current U.S. LCI Plastics Database and the PlasticsEurope Eco-Profiles Database, as well as the previous version of the U.S. LCI Plastics Database.
- Bibliography
- Glossary of Terms

## CHAPTER 1

## STUDY APPROACH AND METHODOLOGY

## OVERVIEW

The cradle-to-gate life cycle inventory (LCI) presented in this study quantifies the total energy requirements, energy sources, atmospheric pollutants, waterborne pollutants, and solid waste resulting from the production of nine plastic resins and four polyurethane precursors. It is considered a cradle-to-gate LCI because this analysis ends at the resin/precursor production process. The system boundaries stop at resin or precursor production so that the resin/precursor data can be linked with fabrication, use, and end-of-life data to create full life cycle inventories for a variety of plastic products. The methodology used for this inventory is consistent with the methodology for Life Cycle Inventory (LCI) in the ISO 14040 Standard documents, specifically 14040, 14041, and 14043.

This analysis is not an impact assessment. It does not attempt to determine the fate of emissions, or the relative risk to humans or to the environment due to emissions from the systems. In addition, no judgments are made as to the merit of obtaining natural resources from various sources.

A life cycle inventory quantifies the energy consumption and environmental emissions (i.e., atmospheric emissions, waterborne emissions, and solid wastes) for a given product based upon the study boundaries established. Figure 1-1 illustrates the general approach used in a full LCI analysis. This cradle-to-gate LCI analysis stops after the “Materials Manufacture” box shown in the figure below.

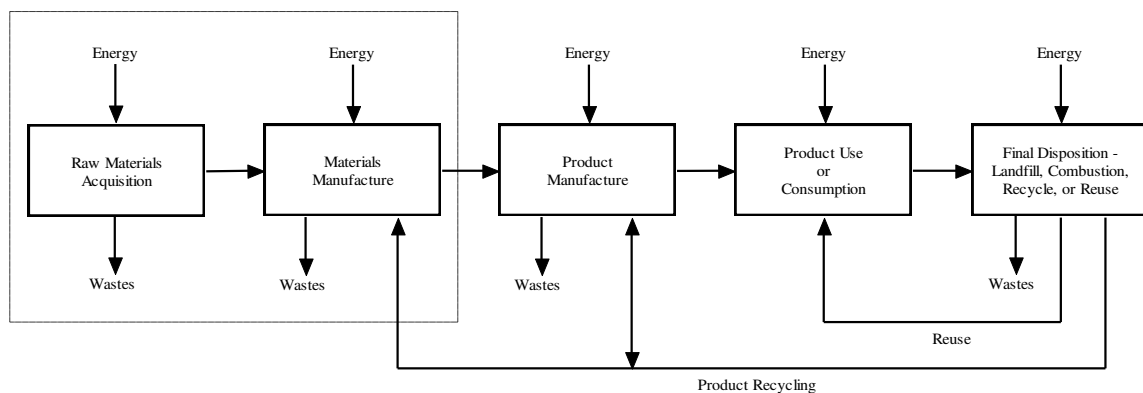

Figure 1-1. General materials flow for "cradle-to-grave" analysis of a product system. The dashed box indicates the boundaries of this LCI analysis. No recycled content or recycling is included in this analysis.

## Study Goal and Intended Audience

This cradle-to-gate LCI of selected plastic resins and polyurethane precursors has been conducted to provide the Plastics Division of the ACC (and the greater plastics industry), with an updated average database on the production of commonly used plastic resins and polyurethane precursors. In due course, this plastics LCI database will be included in the U.S. Life Cycle Database, which is overseen by the National Renewable Energy Laboratory (NREL).

The intent of the study was to develop life cycle profiles for each of the plastic resins and polyurethane precursors using data from industry data, where available. Environmental profiles presented in this report for the plastic resins, polyurethane precursors, and a limited number of intermediate chemicals were developed using the data provided by participating companies for this study. For some intermediate chemicals and all raw materials, the energy and environmental data presented in this report were developed using the best and most current data available from Franklin Associates' U.S. life cycle database, updated to the extent possible to represent current technology using the data resources available.

## U.S. Life Cycle Database Project

The primary intended audience for the report is member companies; however, the LCI data will be publicly available within the U.S. LCI Database at the U.S. LCI Database website (<http://www.nrel.gov/lci/>). The results for this analysis are presented in both English and Metric units for the benefit of the eventual intended audience, which may include international users.

Because the Plastics Division of the American Chemistry Council has indicated that a major goal of this study is to make this data available to the U.S. LCI database project, the objectives and requirements of this U.S. LCI database need to be made clear. The U.S. LCI database project research protocol ("the protocol", available at the project website [www.nrel.gov/lci/](http://www.nrel.gov/lci/)) clearly states that "the ultimate objective of the U.S. LCI database project is to develop **publicly available** LCI data modules for commonly used materials, products, and processes." Key elements of the protocol are described in subsequent sections of the protocol. Two elements that are of particular relevance to this project are the unit process approach and transparency requirements.

Section 4 of the protocol addresses the importance of the unit process approach. Data must be collected and presented on a unit process basis "so that users of the data can understand and combine various components of a product system, and so that critical reviewers can conduct technical analyses. Higher levels of aggregation of data (i.e., defining a unit process to involve more activities (such as production of fuels or feedstock materials used in the process) will result in a loss of information, reduce the level of transparency, and inhibit critical review." Data must be prepared on a unit process basis.

Section 12 of the protocol describes transparency requirements. “Central transparency objectives of the U.S. LCI database project are to develop and publish LCI data in a form that provides enough information about the nature and sources of the data so that users and third parties can do the following for each data item:

- Know the source(s) and age of the data;
- Know how well the data represents an industry or process;
- Understand how the underlying calculations were made;
- Evaluate the appropriateness of the data for the user’s intended application;
- Validate the results through testing and cross-checking of data and modeling; and, ultimately,
- Make an informed determination concerning the extent to which they can rely on the data and conclusions drawn from it.”

Thus, in order for the resin databases developed here to be usable in the U.S. LCI database, the unit processes must meet the transparency requirements. Rolled-up data sets and data sets without documentation are not acceptable. All unit process data are shown in the Appendices of this report (separate document) in as much individual detail as confidentiality issues permit. Also, the unit process datasets for each resin or precursor have been linked to construct a cradle-to-resin/precursor process chain as well.

The existing public/private partnership U.S. LCI database is continuously being populated with data. Franklin Associates provided a fuels and energy database (e.g., coal mining, electricity generation, petroleum refining, and the like) in 2003. With this LCI analysis, the Plastics Division of ACC now has cradle-to-resin process chains published for access via the U.S. LCI database, as well as for its independent use.

### **Study Scope and Boundaries**

This cradle-to-gate LCI encompasses production of the resins and precursors from raw material acquisition to resin production, rather than for a single manufacturing step or environmental emission. The study boundaries of this partial LCI of plastic resins and polyurethane precursors include the following elements:

- Raw materials acquisition
- Production of intermediate chemicals
- Production of the plastic resin or polyurethane precursor.

Detailed process flow diagrams, along with brief descriptions of processes for each resin or precursor can be found in the Appendices (separate document). The LCI quantifies energy and resource use, solid waste, and individual atmospheric and waterborne emissions for all stages listed above in the life cycle of each resin or precursor. Transportation of the resin or precursor to a manufacturer, fabrication of a product, and use of that product by consumers is not included in the study. Environmental burdens associated with end-of-life management of plastic products are not considered in this analysis.

The scope of the project does not include the manufacture of fillers, additives, or plasticizers that may be added to the resins/precursors analyzed. These types of materials/chemicals are commonly added to many of the resins/precursors; however, they depend highly on the type of product the resin is intended to produce.

## LIFE CYCLE INVENTORY METHODOLOGY

Key elements of the LCI methodology include the study boundaries, resource inventory (raw materials and energy), emissions inventory (atmospheric, waterborne, and solid waste), and disposal practices. Additional discussion on the methodology used to calculate product life cycle resource and environmental emissions is presented in the following section of this chapter.

Franklin Associates developed a methodology for performing resource and environmental profile analyses (REPA), commonly called life cycle inventories. This methodology has been documented for the U.S. Environmental Protection Agency and is incorporated in the EPA report **Product Life-Cycle Assessment Inventory Guidelines and Principles**. The methodology is also consistent with the life cycle inventory methodology described in the ISO 14040 standards:

- ISO 14040 Environmental Management—Life Cycle Assessment—Principles and Framework. Reference No. ISO 14040:1997(E)
- ISO 14041 Environmental Management—Life Cycle Assessment—Goal and Scope Definition and Inventory Analysis. Reference No. 14041:1998(E)
- ISO 14043 Environmental Management—Life Cycle Assessment—Life Cycle Interpretation. Reference No. 14043:2000(E).

The data presented in this report were developed using this methodology, which has been in use for over 35 years.

Figure 1-2 illustrates the basic approach to data development for each major process in an LCI analysis. This approach provides the essential building blocks of data used to construct a complete resource and environmental emissions inventory profile for the entire life cycle of a product. Using this approach, each individual process included in the study is examined as a closed system, or “black box”, by fully accounting for all resource inputs and process outputs associated with that particular process. Resource inputs accounted for in the LCI include raw materials and energy use, while process outputs accounted for include products manufactured and environmental emissions to land, air, and water.

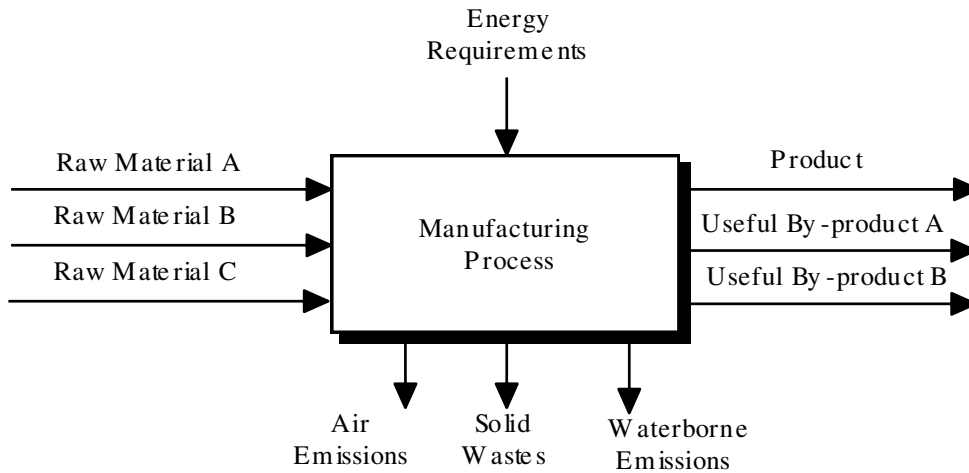

Figure 1-2. "Black box" concept for developing LCI data.

For each process included in the study, resource requirements and environmental emissions are determined and expressed in terms of a standard unit of output. A standard unit of output is used as the basis for determining the total life cycle resource requirements and environmental emissions of a product.

### Material Requirements

Once the LCI study boundaries have been defined and the individual processes identified, a material balance is performed for each individual process. This analysis identifies and quantifies the input raw materials required per standard unit of output, such as 1,000 pounds or 1,000 kilograms, for each individual process included in the LCI. The purpose of the material balance is to determine the appropriate weight factors used in calculating the total energy requirements and environmental emissions associated with the resins or precursors. Energy requirements and environmental emissions are determined for each process and expressed in terms of the standard unit of output.

Once the detailed material balance has been established for a standard unit of output for each process included in the LCI, a comprehensive material balance for the entire life cycle of each product system is constructed. This analysis determines the quantity of materials required from each process to produce and dispose of the required quantity of each system component and is typically illustrated as a flow chart. Data must be gathered for each process shown in the flow diagram, and the weight relationships of inputs and outputs for the various processes must be developed.

## Energy Requirements

The average energy requirements for each process identified in the LCI are first quantified in terms of fuel or electricity units, such as cubic feet of natural gas, liters of diesel fuel, or kilowatt-hours (kWh) of electricity. [The Appendices document presents fuel requirements for each process in both English and Standardized International (SI) units]. The fuel used to transport raw materials to each process is included as a part of the LCI energy requirements. Transportation energy requirements for each step in the life cycle are developed in the conventional units of ton-miles by each transport mode (e.g. truck, rail, barge, etc.). Government statistical data for the average efficiency of each transportation mode are used to convert from ton-miles to fuel consumption.

Once the fuel consumption for each industrial process and transportation step is quantified, the fuel units are converted from their original units to an equivalent Btu value based on standard conversion factors.

The conversion factors have been developed to account for the energy required to extract, transport, and process the fuels and to account for the energy content of the fuels. The energy to extract, transport, and process fuels into a usable form is labeled precombustion energy. For electricity, precombustion energy calculations include adjustments for the average efficiency of conversion of fuel to electricity and for transmission losses in power lines based on national averages.

The LCI methodology assigns a fuel-energy equivalent to raw materials that are derived from fossil fuels. Therefore, the total energy requirement for coal, natural gas, or petroleum based materials includes the fuel-energy of the raw material (called energy of material resource or inherent energy). In this study, this applies to the crude oil and natural gas used to produce the plastic resins and polyurethane precursors. No fuel-energy equivalent is assigned to combustible materials, such as wood, that are not major fuel sources in North America.

During the production of some hydrocarbons, an offgas or fuel gas is produced during the reaction. A portion of this offgas or fuel gas is used within the hydrocarbon production to produce steam or heat, while any remaining portion is exported from the hydrocarbon production as a coproduct, as discussed below. The offgas used within the production is shown as a weight of natural gas and petroleum input to produce the energy, as well as the energy amount produced from those weights.

When fuel coproducts, such as offgas, are exported from the hydrocarbon production, they carry with them the allocated share of the inputs and outputs for their production. The ratio of the mass of the exported fuel over the total mass output was removed from the total inputs and outputs of the process, and the remaining inputs and outputs are allocated over the material products (Equation 1).

$$\mathbf{IO} \times \left( 1 - \frac{M_{EO}}{M_{Total}} \right) = \mathbf{IO}_{\text{attributed to remaining products}} \quad (\text{Equation 1})$$

where

$IO$  = Input/Output Matrix to produce all products/coproducts

$M_{EO}$  = Mass of Exported Offgas

$M_{Total}$  = Mass of all Products and Coproducts (including fuels)

No energy credit is applied for the exported fuels, since both the inputs and outputs for the exported fuels have been removed from the data set.

The Btu values for fuels and electricity consumed in each industrial process are summed and categorized into an energy profile according to the six basic energy sources listed below:

- Natural gas
- Petroleum
- Coal
- Nuclear
- Hydropower
- Other

The “other” category includes nonconventional sources, such as solar, biomass and geothermal energy. Also included in the LCI energy profile are the Btu values for all transportation steps and all fossil fuel-derived raw materials. Energy requirements for each resin/precursor examined in this LCI are presented in their individual chapters (2 through 12).

## Environmental Emissions

Environmental emissions are categorized as atmospheric emissions, waterborne emissions, and solid wastes and represent discharges into the environment after the effluents pass through existing emission control devices. Similar to energy, environmental emissions associated with processing fuels into usable forms are also included in the inventory. When it is not possible to obtain actual industry emissions data, published emissions standards are used as the basis for determining environmental emissions.



The different categories of atmospheric and waterborne emissions are not totaled in this LCI because it is widely recognized that various substances emitted to the air and water differ greatly in their effect on the environment. Individual environmental emissions for each resin/precursor are presented in their individual chapters (2 through 12).

**Atmospheric Emissions.** These emissions include substances classified by regulatory agencies as pollutants, as well as selected nonregulated emissions such as carbon dioxide. For each process, atmospheric emissions associated with the combustion of fuel for process or transportation energy, as well as any emissions released from the process itself, are included in this LCI. Emissions are reported as both pounds of pollutant per 1,000 pounds of resin/precursor and kilograms of pollutant per 1,000 kilograms of resin/precursor. The amounts reported represent actual discharges into the atmosphere after the effluents pass through existing emission control devices. Some of the more commonly reported atmospheric emissions are: carbon dioxide, carbon monoxide, non-methane hydrocarbons, nitrogen oxides, particulates, and sulfur oxides.

**Waterborne Emissions.** As with atmospheric emissions, waterborne emissions include all substances classified as pollutants. Waterborne emissions are reported as both pounds of pollutant per 1,000 pounds of resin/precursor and kilograms of pollutant per 1,000 kilograms of resin/precursor. The values reported are the average quantity of pollutants still present in the wastewater stream after wastewater treatment and represent discharges into receiving waters. This includes both process-related and fuel-related waterborne emissions. Some of the most commonly reported waterborne emissions are: acid, ammonia, biochemical oxygen demand (BOD), chemical oxygen demand (COD), chromium, dissolved solids, iron, and suspended solids.

A large amount of primary data was used in this analysis. Many of the plants that provided data are part of a larger company site with one water treatment plant for all individual process plants on-site. In some cases, it was not possible for a plant to determine what waterborne emissions from the facility's on-site treatment plant were associated with the specific processes of interest for this study. This situation was handled in one of two ways depending on the company. Either the plant did not provide their waterborne emissions data for use in this study, or the plant provided their waterborne emissions data for the specific process(es) of interest before the effluent was sent to the water treatment plant.

If a plant did not provide water emissions, that plant was excluded from the industry average calculation for those waterborne emissions. However, at least 1 plant did provide waterborne emissions data in all resin/precursor average datasets. In the cases of less than three plants providing this data, the order of magnitude of the emissions were included with the approval of the data provider(s).

In a few cases, plants provided the waterborne emissions data before the effluent was sent to the water treatment plant. Where this is the case, the data was included, and a footnote on the corresponding process table in the appendix remarks that those emissions may be overstated.

A few companies send their waterborne emissions to deepwell disposal. For this analysis, waterborne emissions sent to deepwell disposal were not included. Individual process descriptions found in the separate Appendices discuss the inclusion of deepwell disposal by companies.

**Solid Wastes.** This category includes solid wastes generated from all sources that are landfilled or disposed of in some other way, such as incineration with or without energy recovery. It does not include materials that are recovered for reuse or recycling.

Because this analysis is a cradle-to-gate LCI, and no products are fabricated, postconsumer wastes are not included. Only industrial wastes from processes and fuel-production are considered. Examples of industrial solid wastes are wastewater treatment sludge, solids collected in air pollution control devices, scrap or waste materials from manufacturing operations that are not recycled or sold, and fuel combustion residues such as the ash generated by burning coal.

## LCI PRACTITIONER METHODOLOGY VARIATION

There is general consensus among life cycle practitioners on the fundamental methodology for performing LCIs.<sup>1</sup> However, for some specific aspects of life cycle inventory, there is some minor variation in methodology used by experienced practitioners. These areas include the method used to allocate energy requirements and environmental releases among more than one useful product produced by a process and the method used to account for the energy contained in material feedstocks. LCI practitioners vary to some extent in their approaches to these issues. The following sections describe the approach to each issue used in this study. A discussion of methodology differences between this U.S. plastics LCI database and the PlasticsEurope LCI database is found in an attached addendum to this report.

### Coproduct Credit

One unique feature of life cycle inventories is that the quantification of inputs and outputs are related to a specific amount of product from a process. However, it is sometimes difficult or impossible to identify which inputs and outputs are associated with individual products of interest resulting from a single process (or process sequence) that produces multiple useful products. The practice of allocating inputs and outputs among

---

<sup>1</sup> ISO 14040. Environmental Management—Life Cycle Assessment—Principles and Framework. Reference No. ISO 14040:1997(E).

multiple products from a process is often referred to as “coproduct credit”<sup>2</sup> or “partitioning”<sup>3</sup>.

Coproduct credit is done out of necessity when raw materials and emissions cannot be directly attributed to one of several product outputs from a system. It has long been recognized that the practice of giving coproduct credit is less desirable than being able to identify which inputs lead to particular outputs.

Franklin Associates follows the guidelines for allocating coproduct credit shown in the ISO 14040 series. In the ISO 14040 series, the preferred hierarchy for handling allocation is (1) avoid allocation where possible, (2) allocate flows based on direct physical relationships to product outputs, (3) use some other relationship between elementary flows and product output. No single allocation method is suitable for every scenario. How product allocation is made will vary from one system to another but the choice of parameter is not arbitrary. The aim should be to find an allocation parameter that in some way reflects, as closely as possible, the physical behavior of the system itself.<sup>4</sup>

Some processes lend themselves to physical allocation because they have physical parameters that provide a good representation of the environmental burdens of each coproduct. Examples of various allocation methods are mass, stoichiometric, elemental, reaction enthalpy, and economic allocation. Simple mass and enthalpy allocation have been chosen as the common forms of allocation in this analysis. However, these allocation methods were not chosen as a default choice, but made on a case by case basis after due consideration of the chemistry and basis for production.

In this analysis, coproduct credit is assigned to any useful process output that is produced and sold, whether it is produced and removed by choice or out of necessity.

All scrap coproduct in this analysis was allocated on a mass basis. All off-spec/scrap amounts for the plastics were 3 percent or less. Economic allocation was ruled out as it depends on the economic market, which can change dramatically over time depending on many factors unrelated to the chemical and physical relationships between process inputs and outputs. Useful scrap that is produced and sold should be allocated its share of the raw materials and energy required, as well as emissions released.

---

<sup>2</sup> Hunt, Robert G., Sellers, Jere D., and Franklin, William E. **Resource and Environmental Profile Analysis: A Life Cycle Environmental Assessment for Products and Procedures**. Environmental Impact Assessment Review. 1992; 12:245-269.

<sup>3</sup> Boustead, Ian. **Eco-balance Methodology for Commodity Thermoplastics**. A report for The Centre for Plastics in the Environment (PWMI). Brussels, Belgium. December, 1992.

<sup>4</sup> Dr. David A. Russell, Sustainable Development and EH&S Business Integration Dow Europe GmbH; also currently Chairman of PlasticsEurope Life Cycle Task Force (formerly APME). November 17, 2004.

When the coproduct was heat or steam the energy amount (Btu or J) of the heat, steam, or fuel was shown as recovered energy category. If the coproduct was exported as a fuel, it carried with it the allocated share of the inputs and outputs for its production.

When looking at the steam cracking of hydrocarbons, either mass allocation or enthalpy allocation could have been used on the many coproducts of this process. Because of the variety of raw materials (from the steam cracker) used in the resins (ethylene, propylene, hexene, butene, octene, etc.) and such small heating value differences (<5%) between most of the steam cracking coproducts, mass allocation was used. Another case for mass allocation for steam cracking is any variety of the olefins could be used for raw materials in polyethylene resins. If a user of the U.S. LCI database is unaware of the specific raw materials (that is, they only know that olefins are used), the olefins unit process covers all of the specific possibilities.

In the US LCI database, unit process data are presented on a transparent, thoroughly documented basis. In cases where co-product allocation is necessary, both the raw (unallocated) data and the allocated data set are usually shown. However, because the primary datasets in this analysis are an average of numerous plants which do not always use the same technologies or produce the same coproducts, an allocation method has been chosen based on the hierarchy of the ISO 14040 series for each company dataset, and only the averages, which includes the allocated dataset(s), are shown in the unit process tables (see separate Appendices). Confidentiality issues prohibit the revealing of each plant's individual coproduct amounts. This is due to the fact that coproduct allocation is performed on each individual plant dataset, and then the allocated datasets are averaged.

### **Energy of Material Resource**

For some raw materials, such as petroleum, natural gas, and coal, the amount consumed in all industrial applications as fuel far exceeds the amount consumed as raw materials (feedstock) for products. The primary use of these materials in the marketplace is for energy. The total amount of these materials can be viewed as an energy pool or reserve. This concept is illustrated in Figure 1-3.

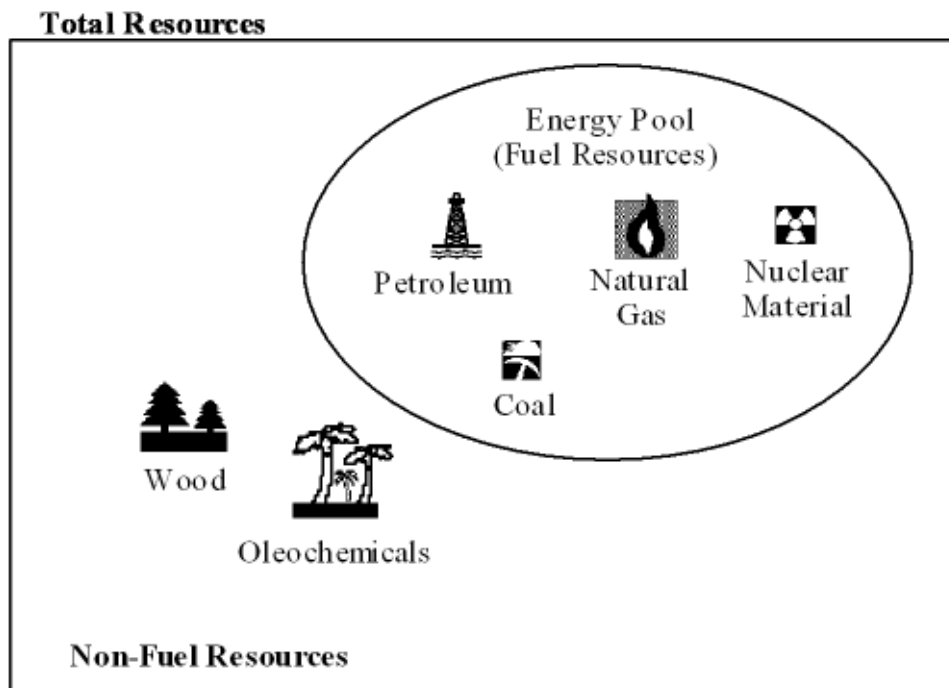

Figure 1-3. Illustration of the Energy of Material Resource Concept.

The use of a certain amount of these materials as feedstocks for products, rather than as fuels, removes that amount of material from the energy pool, thereby reducing the amount of energy available for consumption. This use of available energy as feedstock is called the “energy of material resource” and is included in the inventory. The energy of material resource represents the amount the energy pool is reduced by the consumption of fuel materials as raw materials in products and is quantified in energy units.

The energy of material resource is the energy content of the fuel materials *input* as raw materials or feedstocks. The energy of material resource assigned to a material is *not* the energy value of the final product, but is the energy value of the raw material at the point of extraction from its natural environment. For fossil fuels, this definition is straightforward. For instance, petroleum is extracted in the form of crude oil. Therefore, the energy of material resource for petroleum is the higher heating value of crude oil.

Once the feedstock is converted to a product, there is energy content that could be recovered, for instance through combustion in a waste-to-energy waste disposal facility. The energy that can be recovered in this manner is always somewhat less than the feedstock energy because the steps to convert from a gas or liquid to a solid material reduce the amount of energy left in the product itself. The maximum amounts of energy that could potentially be recovered from combustion of the nine plastics considered in this analysis are shown in Table 1-1 based on the higher heating value (HHV) of each resin. In North America, energy content is most often quoted as HHV; this value is determined when the product is burned and the product water formed is condensed. The use of HHV is considered preferable from the perspective of energy efficiency analysis,

as it is a better measure of the energy inefficiency of processes.<sup>5</sup> Lower heating values (LHV), or net heating values, measure the heat of combustion when the water formed remains in the gaseous state. The difference between the HHV and the LHV depends on the hydrogen content of the product. As the carbon amount of the combusted material climbs higher, the difference in these two values levels off to approximately 7.5 percent.<sup>6</sup> A good estimate of the LHV for each of the plastics can be calculated by multiplying the HHV values in Table 1 by 0.925.

The energy amounts in Table 1-1 are for pure resin only. If additives or plasticizers are added to the resin, the heating values will vary.

**Table 1-1**

**Higher Heating Values for the Plastic Resins Analyzed**

<u>Plastic Resin</u>	<u>Higher Heating Value</u>	
	<u>(Btu/lb)</u>	<u>(MJ/kg)</u>
HDPE	19,985	46.5
LDPE	19,877	46.2
LLDPE	19,946	46.4
PP	19,948	46.4
PET	10,600	24.7
GPPS	18,000	41.9
HIPS	18,000	41.9
PVC	7,875	18.3
ABS	15,500	36.1

References: Fire, Frank L. **Combustibility of Plastics**. Van Nostrand. Reinhold. 1991.

**Thermodynamic Data for Biomass Materials and Waste Components**. The American Society of Mechanical Engineers. 1987.

Source: Franklin Associates, a Division of ERG

The materials are primarily used as fuels but can also be used as material inputs can change over time and with location. In the industrially developed countries included in this analysis, these materials are petroleum, natural gas, and coal. While some wood is burned for energy, the primary uses for wood are for products such as paper and lumber. Similarly, some oleochemical oils such as palm oils are burned for fuels, often referred to as “bio-diesel.” However, as in the case of wood, their primary consumption is as raw materials for products such as soaps, surfactants, cosmetics, etc.

<sup>5</sup> Worrell, Ernst, Dian Phylipsen, Dan Einstein, and Nathan Martin. **Energy Use and Energy Intensity of the U.S. Chemical Industry**. Ernest Orlando Lawrence Berkeley National Laboratory. April, 2000. p. 12.

<sup>6</sup> Seddon, Dr. Duncan. **Gas Usage & Value**. PennWell Books. 2006. p. 76. Figure 4-1.

## DATA

The accuracy of the study is only as good as the quality of input data. The development of methodology for the collection of data is essential to obtaining quality data. Careful adherence to that methodology determines not only data quality but also objectivity. Franklin Associates has developed a methodology for incorporating data quality and uncertainty into LCI calculations. Data quality and uncertainty are discussed in more detail at the end of this section.

If a user of this report is interested in the specific source of an individual emission shown in the results tables, information on emission sources can be found within the appendix tables. Table 1 of each resin/precursor appendix shows the full list of emissions released from the sequence of material production processes for each resin/precursor. If the emission of interest is listed in Table 1, a reader can then go through the individual appendix tables for each process shown in the flow diagram for that resin/precursor to identify the specific process source(s) of that emission. If the emission of interest is not listed in Table 1, then it is emitted from fuel-related sources. Tables listing emissions from the production and combustion of individual fuels are shown in Appendix A.

Data necessary for conducting this analysis are separated into two categories: process-related data and fuel-related data.

### Process Data

**Methodology for Collection/Verification.** The process of gathering data is an iterative one. The data-gathering process for each system begins with a literature search to identify raw materials and processes necessary to produce the final product. The search is then extended to identify the raw materials and processes used to produce these raw materials. In this way, a flow diagram is systematically constructed to represent the production pathway of each system.

Each process identified during the construction of the flow diagram is then researched to identify potential industry sources for data. In this case, the Plastics Division of the ACC contacted member and non-member companies producing the resins/precursors to be included in this analysis. The companies that agreed to participate in this analysis by collecting process data were contacted, and worksheets and instructions developed specifically for this project were provided to assist in gathering the necessary process data for their product(s).

Upon receipt of the completed worksheets, the data were evaluated for completeness and reviewed for any material inputs that were additions or changes to the flow diagrams. In this way, the flow diagrams were revised to represent current industrial practices. Data suppliers were then contacted again to discuss the data, process technology, waste treatment, identify coproducts, and any assumptions necessary to understand the data and boundaries.

After each dataset was completed and verified, allocation is performed for any coproducts at the plant. Then, the datasets for each process were aggregated into a single set of data for that process. The method of aggregation for each process was determined on a case-by-case basis. Commonly, these datasets were weighted by plant production amount percentages. However, if more than one process technology was involved, market shares for these processes were used to create a weighted average (e.g. benzene production). In this way, a representative set of data can be estimated from a limited number of data sources. The provided process dataset and assumptions were then documented and returned with the aggregated data to each data supplier for their review.

**Confidentiality.** The data requested in the worksheets are often considered proprietary by potential suppliers of data. The method used to collect and review data provides each supplier the opportunity to review the aggregated average data calculated from all data supplied by industry. This allows each supplier to verify that their company's data are not being published and that the averaged data are not aggregated in such a way that individual company data can be calculated or identified.

**Objectivity.** Each unit process is researched independently of all other processes. No calculations are performed to link processes together with the production of their raw materials until after data gathering and review are complete. The procedure of providing the aggregated data and documentation to suppliers and other industry experts provides several opportunities to review the individual data sets without affecting the objectivity of the research. This process serves as an external expert review of each process. Also, because these data are reviewed individually, assumptions are reviewed based on their relevance to the process rather than their effect on the overall outcome of the study.

**Data Sources.** As stated in the **Study Goal** section, the intended purpose of the study was to develop life cycle profiles for the resins/precursors using the most up-to-date primary data collected from the companies producing each resin/precursor.

Data collected specifically for this study include data on the production of the following chemicals, resins, and precursors:

- Olefins hydrocracking
- High-density polyethylene (HDPE) resin
- Low-density polyethylene (LDPE) resin
- Linear low-density polyethylene (LLDPE) resin
- Polypropylene (PP) resin
- Acetic acid
- Crude terephthalic acid (TPA)/dinitrotoluene (DNT)/purified terephthalic acid (PTA)/polyethylene terephthalate (PET) resin
- Benzene
- Ethylbenzene/styrene
- General-purpose polystyrene (GPPS) resin
- High-impact polystyrene (HIPS) resin



- Chlorine/caustic soda
- Ethylene dichloride (EDC)/vinyl chloride monomer (VCM)
- Polyvinyl chloride (PVC) resin
- Acrylonitrile
- Acrylonitrile-butadiene-styrene (ABS) resin
- Polyether polyol for rigid foam polyurethane
- Polyether polyol for flexible foam polyurethane
- Nitrobenzene/aniline
- Methylene diphenylene diisocyanate (MDI)
- Toluene diisocyanate (TDI)

In the case of PVC resin, two emissions (dioxins and vinyl chloride) were provided by The Vinyl Institute in place of the plant data average. In the case of vinyl chloride, the amount was based on 2003 Vinyl Chloride TRI reported values and 2003 PVC production reported by ACC Resin Statistic Report. In the case of dioxins, the amount was based on 2003 Dioxin TRI values and listed EDC capacity for the site assuming an operating rate at EDC capacity. The dioxin amounts were calculated as toxic equivalent values (TEQ). These values were used to represent more industry wide average values to account for facilities that did not participate in the LCI inventory.

Other than the data sets provided by industry for this study, or data developed for this study using secondary data sources, data sets for all other unit processes in this study were taken from Franklin Associates' U.S. industry average database. This database has been developed over a period of years through research for many LCI projects encompassing a wide variety of products and materials.

Another advantage of the database is that it is continually updated. For each ongoing LCI project, verification and updating is carried out for the portions of the database that are accessed by that project.

## **Fuel Data**

When fuels are used for process or transportation energy, there are energy and emissions associated with the production and delivery of the fuels as well as the energy and emissions released when the fuels are burned. Before each fuel is usable, it must be mined, as in the case of coal or uranium, or extracted from the earth in some manner. Further processing is often necessary before the fuel is usable. For example, coal is crushed or pulverized and sometimes cleaned. Crude oil is refined to produce fuel oils, and "wet" natural gas is processed to produce natural gas liquids for fuel or feedstock.

To distinguish between environmental emissions from the combustion of fuels and emissions associated with the production of fuels, different terms are used to describe the different emissions. The combustion products of fuels are defined as "combustion data." Energy consumption and emissions which result from the mining, refining, and transportation of fuels are defined as "precombustion data." Precombustion data and combustion data together are referred to as "fuel-related data."

Fuel-related data are developed for fuels that are burned directly in industrial furnaces, boilers, and transport vehicles. Fuel-related data are also developed for the production of electricity. These data are assembled into a database from which the energy requirements and environmental emissions for the production and combustion of process fuels are calculated.

Energy data are developed in the form of units of each primary fuel required per unit of each fuel type. For electricity production, federal government statistical records provided data for the amount of fuel required to produce electricity from each fuel source, and the total amount of electricity generated from petroleum, natural gas, coal, nuclear, hydropower, and other (solar, geothermal, etc.). Literature sources and federal government statistical records provided data for the emissions resulting from the combustion of fuels in utility boilers, industrial boilers, stationary equipment such as pumps and compressors, and transportation equipment. Because electricity is required to produce primary fuels, which are in turn used to generate electricity, a circular loop is created. Iteration techniques are utilized to resolve this loop.

In 2003, Franklin Associates updated our fuels and energy database for inclusion in the U.S. LCI database. This fuels and energy database is used in this analysis. The oil and natural gas extraction datasets were revised from this 2003 energy database and provided to NREL as an update in August, 2011.

### **Data Quality Goals for This Study**

ISO standards 14040, 14041 and 14043 each detail various aspects of data quality and data quality analysis. ISO 14041 Section 5.3.6 states: “Descriptions of data quality are important to understand the reliability of the study results and properly interpret the outcome of the study.” The section goes on to list three critical data quality requirements: time-related coverage, geographical coverage, and technology coverage. Additional data quality descriptors that should be considered include whether primary or secondary data were used and whether the data were measured, calculated, or estimated.

As described earlier in this chapter, the data quality goal for this study was to use primary data collected from the resin/precursor producers to develop data that were representative of the high-volume resins/precursors currently available in terms of time, geographic, and technology coverage.

In some cases, it was possible to achieve the intended data quality goals of the study in terms of current primary data and geographic and technology coverage. The data sets submitted for polyether polyols and ABS represent at least 50 percent of total North American production of these materials. The data sets provided for the remaining resins cover less than 50 percent of total North American production amount of these materials. While data were provided by a small sample of plants in these cases, the resin producers who provided data verified that the characteristics of their plants are representative of a majority of North American production. The average resin and precursor datasets were

reviewed and accepted respectively by each data provider. These data are current primary data and are considered to be of the highest quality.

Data for most other processes and materials in this study were taken from Franklin Associates' LCI database or estimated based on secondary data sources. The quality of these data vary in terms of age, representativeness, measured values or estimates, etc.; however, all materials and process data sets used in this study were thoroughly reviewed for accuracy and currency and updated to the best of our capabilities for this analysis. All fuel data were reviewed and extensively updated in 2003.

Each chapter of this report includes a brief data quality summary of the key primary data sources used for each resin or precursor. The report bibliography lists the published data sources that were used to develop the LCI models for each resin or precursor. Additional detail on the data sources used in the modeling of each unit process is provided in the separate Appendices document.

### **Data Accuracy**

An important issue to consider when using LCI study results is the reliability of the data. In a complex study with literally thousands of numeric entries, the accuracy of the data and how it affects conclusions is truly a complex subject, and one that does not lend itself to standard error analysis techniques. Techniques such as Monte Carlo analysis can be used to study uncertainty, but the greatest challenge is the lack of uncertainty data or probability distributions for key parameters, which are often only available as single point estimates. However, the reliability of the study can be assessed in other ways.

A key question is whether the LCI profiles are accurate and study conclusions are correct. Because this study develops cradle-to-resin profiles for plastic resins and precursors, rather than comparing functionally equivalent products made from these materials, no comparative conclusions are drawn in this analysis. However, it is important that the environmental profiles accurately reflect the relative magnitude of energy requirements and other environmental burdens for the various materials analyzed.

The accuracy of an environmental profile depends on the accuracy of the numbers that are combined to arrive at that conclusion. Because of the many processes required to produce plastic resins and precursors, many numbers in the LCI are added together for a total numeric result. Each number by itself may contribute little to the total, so the accuracy of each number by itself has a small effect on the overall accuracy of the total. There is no widely accepted analytical method for assessing the accuracy of each number to any degree of confidence. In many cases, plant personnel reported actual plant data. The data reported may represent operations for the previous year or may be representative of engineering and/or accounting methods. All data received are evaluated to determine whether or not they are representative of the typical industry practices for that operation or process being evaluated. Taking into consideration budget considerations and limited industry participation, the data used in this report are believed to be the best that can be currently obtained.

There are several other important points with regard to data accuracy. Each number generally contributes a small part to the total value, so a large error in one data point does not necessarily create a problem. For process steps that make a larger than average contribution to the total, special care is taken with the data quality. It is assumed that with careful scrutiny of the data, any errors will be random. That is, some numbers will be a little high due to errors, and some will be slightly low, but in the summing process these random high and low errors will offset each other to some extent.

There is another dimension to the reliability of the data. Certain numbers do not stand alone, but rather affect several numbers in the system. An example is the amount of a raw material required for a process. This number will affect every step in the production sequence prior to the process. Errors such as this that propagate throughout the system are more significant in steps that are closest to the end of the production sequence. For example, changing the weight of an input to the final polymerization process changes the amounts of the inputs to that process, and so on back to the quantities of crude oil and natural gas.

In summary, for the particular data sources used and for the specific methodology described in this report, the results of this report are believed to be as accurate and reasonable as possible.

### **ISO Data Quality Requirements and Use of Study**

The authors provide the following guidelines and restrictions regarding appropriate use of the study results:

Comparisons between plastic resins should not be made on the basis of cradle-to-resin/precursor results, as the ISO 14040 series of standards require that comparisons of product systems must be made on the basis of equivalent function, and functional equivalence cannot be established without including fabrication of the resin or precursor into a functional product.

### **CRITICAL/PEER REVIEW**

Individual datasets for unit processes in each resin system have been reviewed and approved by industry experts. Unit process data, resin models, and cradle-to-resin results have been reviewed internally by Franklin Associates LCA staff. The energy results have also been reviewed by PlasticsEurope staff, as well as Ian Boustead of Boustead Consulting in 2006-2007.

The Plastics Division of the ACC plans to post the results of this analysis to the U.S. LCI database website. At this time, peer review guidelines have been established, but no formal review process has been implemented. Datasets posted to US LCI database website have a disclaimer noting that they have not undergone a formal external peer review.

## METHODOLOGY ISSUES

The following sections discuss how several key methodological issues are handled in this study.

### Raw Material Use for Internal Energy

As data was collected from data providers in this study, it was noted that the raw material inputs for the hydrocracker were much higher than would be expected to produce the mass of output material. After many discussions with the data providers, it was discovered that some of the raw materials were actually combusted within the hydrocracker, which in turn produced an amount of energy, decreasing the amount of purchased energy required for the reaction. Data providers listed this energy as fuel gas or offgas and supplied the heating value of this gas. Using this information, Franklin Associates calculated the amount of raw material combusted within the hydrocracker to produce offgas energy.

This internal energy is included in the analysis by including the production of the raw materials combusted to produce the energy as well as the energy amount attributed to the combustion of those raw materials. Unlike the raw materials that become part of the product output mass, no energy of material resource is assigned to the raw materials inputs that are combusted within the process. Instead they are assigned an “Internal offgas use” energy.

### Recovered Energy Exported from System Boundaries

Table 2 in each chapter shows a line for recovered energy. This recovered energy is energy (heat or steam) that data providers reported as being exported from the boundaries of the system, so it would replace purchased fuels for another process outside the system. Because it is not known what form of purchased energy the recovered energy would replace, no credit has been given besides recording the recovered energy amount. In Table 1 in each chapter, credit is given to the resin/precursor by subtracting the recovered energy from the process and total energy for a net reduction in energy.

When fuel coproducts, such as offgas, are exported from the hydrocarbon production, they carry with them the allocated share of the inputs and outputs for their production. The ratio of the mass of the exported fuel over the total mass output was removed from the total inputs and outputs of the process, and the remaining inputs and outputs are allocated over the material products (Equation 1).

$$\mathbf{IO} \times \begin{pmatrix} 1 \\ \frac{M_{EO}}{M_{Total}} \end{pmatrix} = \mathbf{IO}_{\text{attributed to remaining products}} \quad (\text{Equation 1})$$

where

$\mathbf{IO}$  = Input/Output Matrix to produce all products/coproducts

$M_{EO}$  = Mass of Exported Offgas

$M_{Total}$  = Mass of all Products and Coproducts (including fuels)

No energy credit is applied for the exported fuels, since both the inputs and outputs for the exported fuels have been removed from the data set.

### **Precombustion Energy and Emissions**

The energy content of fuels has been adjusted to include the energy requirements for extracting, processing, and transporting fuels, in addition to the primary energy of a fuel resulting from its combustion. In this study, this additional energy is called precombustion energy. Precombustion energy refers to all the energy that must be expended to prepare and deliver the primary fuel. Adjustments for losses during transmission, spills, leaks, exploration, and drilling/mining operations are incorporated into the calculation of precombustion energy.

Precombustion environmental emissions (air, waterborne, and solid waste) are also associated with the acquisition, processing, and transportation of the primary fuel. These precombustion emissions are added to the emissions resulting from the burning of the fuels.

### **Electricity Grid Fuel Profile**

In general, detailed data do not exist on the fuels used to generate the electricity consumed by each industry. Electricity production and distribution systems in the United States are interlinked and are not easily separated. Users of electricity, in general, cannot specify the fuels used to produce their share of the electric power grid. Therefore, the U.S. average fuel consumption by electrical utilities is assumed.

Electricity generated on-site at a manufacturing facility is represented in the process data by the fuels used to produce it. A portion of on-site generated electricity is sold to the electricity grid. This portion is accounted for in the calculations for the fuel mix in the grid.

Data for this analysis was collected from plants in the U.S., Canada, and Mexico. Although a number of datasets are from Canada and Mexico, the overall production percentages of each resin/precursor per individual country would be needed to represent the electricity grid of the specific resin/precursor accurately. Access to statistics on the relative U.S. and Canadian production percentages for each resin was not available; thus, for consistency the U.S. electricity grid, which was updated in the U.S. LCI database in 2003, was used.

### **Electricity/Heat Cogeneration**

Cogeneration is the use of steam for generation of both electricity and heat. The most common configuration is to generate high temperature steam in a cogeneration boiler and use that steam to generate electricity. The steam exiting the electricity turbines

is then used as a process heat source for other operations. Significant energy savings occur because in a conventional operation, the steam exiting the electricity generation process is condensed, and the heat is dissipated to the environment.

For LCI purposes, the fuel consumed and the emissions generated by the cogeneration boiler need to be allocated to the two energy-consuming processes: electricity generation and subsequent process steam. Because these are both energy-consuming processes, the logical basis for allocation is Btu of energy.

In order to allocate fuel consumption and environmental emissions to both electricity and steam generation, the share of the two forms of energy (electrical and thermal) produced must be correlated to the quantity of fuel consumed by the boiler. Data on the quantity of fuel consumed and the associated environmental emissions from the combustion of the fuel, the amount of electricity generated, and the thermal output of the steam exiting electricity generation must be known in order to allocate fuel consumption and environmental emissions accordingly. These three types of data are discussed below.

1. **Fuels consumed and emissions generated by the boiler:** The majority of data providers for this study reported natural gas as the fuel used for cogeneration. According to 2003 industry statistics, natural gas accounted for 59 percent of industrial cogeneration, while coal and waste gases accounted for 28 percent and 13 percent, respectively. For this analysis, the data for the combustion of natural gas in industrial boilers was used to determine the environmental emissions from natural gas combustion in cogeneration boilers. For cases in which coal is used in cogeneration boilers, the data for the combustion of bituminous coal in industrial boilers is recommended. For cases in which waste gas is used in cogeneration boilers, the data for the combustion of LPG (liquefied petroleum gas) in industrial boilers is recommended.
2. **Kilowatt-Hours of Electricity Generated:** In this analysis, the data providers reported the kilowatt-hours of electricity from cogeneration. The Btu of fuel required for this electricity generation was calculated by multiplying the kilowatt-hours of electricity by 6,826 Btu/kWh (which utilizes a thermal to electrical conversion efficiency of 50 percent). This Btu value was then divided by the Btu value of fuel consumed in the cogeneration boiler to determine the electricity allocation factor. Note that the kilowatt-hours of electricity generation and consumption of fuel must be on the same production basis, whether a common unit of time or a specified quantity of fuel consumption.
3. **Thermal Output of Steam Exiting Electricity Generation:** In this analysis, the data providers stated the pounds and pressure of steam from cogeneration. The thermal output (in Btu) of this steam was calculated from enthalpy tables (in most cases steam ranged from 1,000 to 1,200 Btu/lb). An efficiency of 80 percent was used for the industrial boiler to

calculate the amount of fuel used. This Btu value was then divided by the Btu value of fuel consumed in the cogeneration boiler to determine the steam allocation factor. Note that the thermal output of steam and consumption of fuel must be on the same production basis, whether a common unit of time or a specified quantity of fuel consumption.

## METHODOLOGICAL DECISIONS

Some general decisions are always necessary to limit a study such as this to a reasonable scope. It is important to understand these decisions. The key assumptions and limitations for this study are discussed in the following sections.

### Geographic Scope

Data collected for this analysis came from plants located in North America, including the U.S., Canada, and Mexico.

Data for foreign processes are generally not available. This is usually only a consideration for the production of oil that is obtained from overseas. In cases such as this, the energy requirements and emissions are assumed to be the same as if the materials originated in the United States. Since foreign standards and regulations vary from those of the United States, it is acknowledged that this assumption may introduce some error. Fuel usage for transportation of materials from overseas locations is included in the study.

### System Components Not Included

The following components of each system are not included in this LCI study:

**Water Consumption.** In primary datasets collected for this analysis, water consumption data was collected for each resin/precursor and for some of the intermediate chemicals. These collected water consumption data can be found in the unit process tables in the Appendices (separate document), but were not included in the cradle-to-resin average datasets due to the lack of corresponding data for the raw materials and intermediate chemicals.

In this analysis, water consumption is defined as the following: (1) water consumed in the process(es) (e.g. water that becomes part of the product or evaporation loss), and (2) water removed from one water source and released to a different receiving body of water. Cooling water that is circulated in a closed-loop system is not included.

**Water Use, Land Use, and Farming.** Because of the lack of availability of good data on water use for raw material and intermediate unit processes, Franklin Associates' LCI database does not include water use, nor does Franklin Associates' database include data on land use and erosion.



The quantities and compositions of pesticides, herbicides, and other chemical agents used in farming vary widely, and data on the production of specialized agricultural chemicals are largely unavailable. Thus, production and use of these materials is not included in the analysis, although the LCI does include the production of basic fertilizer inputs used in farming.

**Capital Equipment.** The energy and wastes associated with the manufacture of capital equipment are not included. This includes equipment to manufacture buildings, motor vehicles, and industrial machinery. The energy and emissions associated with such capital equipment generally, for 1,000 pounds (or kilograms) of materials, become negligible when averaged over the millions of pounds (or kilograms) of product manufactured over the useful lifetime of the capital equipment.

**Space Conditioning.** The fuels and power consumed to heat, cool, and light manufacturing establishments are omitted from the calculations in most cases. For manufacturing plants that carry out thermal processing or otherwise consume large amounts of energy, space conditioning energy is quite low compared to process energy. Energy consumed for space conditioning is usually less than one percent of the total energy consumption for the manufacturing process. This assumption has been checked in the past by Franklin Associates staff using confidential data from manufacturing plants. The data collection forms developed for this project specifically requested that the data provider exclude energy use for space conditioning, or indicate if the reported energy requirements included space conditioning.

**Support Personnel Requirements.** The energy and wastes associated with research and development, sales, and administrative personnel or related activities have not been included in this study. Similar to space conditioning, energy requirements and related emissions are assumed to be quite small for support personnel activities.

**Miscellaneous Materials and Additives.** Selected materials such as catalysts, pigments, or other additives which total less than one percent by weight of the net process inputs are not included in the assessment. Omitting miscellaneous materials and additives helps keep the scope of the study focused and manageable within budget and time constraints. However, it is possible that some toxic emissions may be released from the production of these materials and additives. As noted earlier in Chapter 1, additives such as plasticizers, stabilizers, etc. added to resins or precursors to adapt them for specific product applications were not included, since the purpose of the analysis was to provide data that can be linked to fabrication data sets to model a wide variety of plastic products.

## CHAPTER 2

## CRADLE-TO-RESIN LIFE CYCLE INVENTORY RESULTS FOR HDPE RESIN

This chapter presents LCI results for the production of high-density polyethylene (HDPE) resin (cradle-to-resin). The results are given on the bases of 1,000 pounds and 1,000 kilograms of HDPE resin. Figure 2-1 presents the flow diagram for the production of HDPE resin. Process descriptions and individual process tables for each box shown in the flow diagram can be found in Appendix B of the Appendices (separate document).

Primary data was collected for olefins and HDPE resin production. A weighted average using production quantities was calculated from the olefins production data collected from three leading producers (8 thermal cracking units) in North America. As of 2003, there were 16 olefin producers and at least 29 olefin plants in the U.S. The captured production amount is approximately 30 percent of the available capacity for olefin production. Numerous coproduct streams are produced from the olefins hydrocracker. Fuel gas and off-gas were two of the coproducts produced that were exported to another process for fuel. When these fuel coproducts are exported from the hydrocracker, they carry with them the allocated share of the inputs and outputs for their production. The separate appendices provide an in-depth discussion of this allocation. A mass basis was used to allocate the credit to the remaining material coproducts.

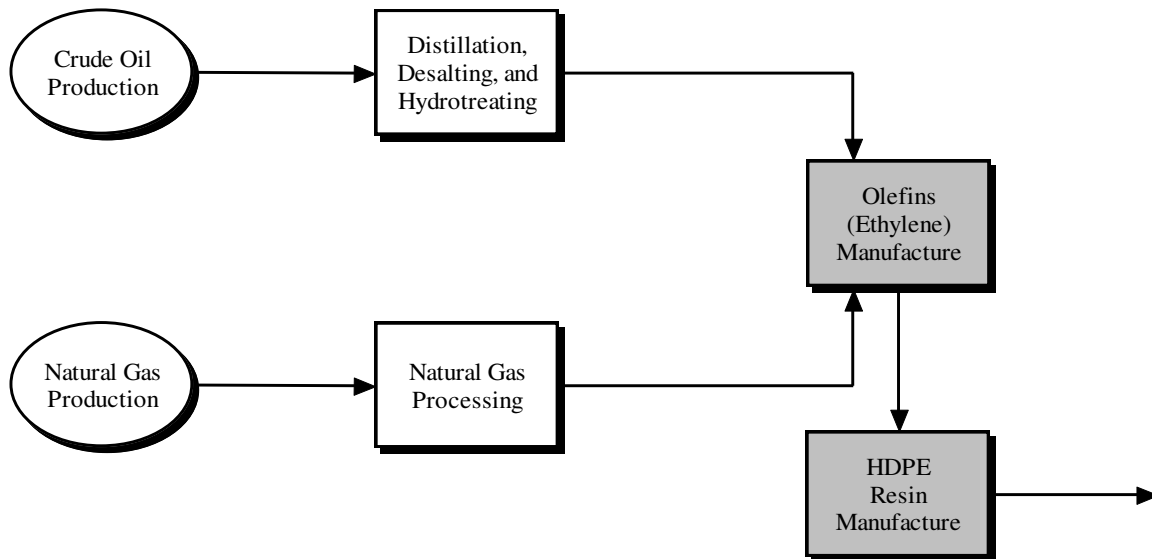

Figure 2-1. Flow diagram for the manufacture of virgin high-density polyethylene (HDPE) resin. Shaded boxes represent partial or complete data provided by manufacturers specifically for this analysis.

A weighted average using production amounts was calculated from the HDPE production data from five plants collected from three leading producers in North America. As of 2003, there were 10 HDPE producers and 23 HDPE plants in the U.S. The captured production amount is approximately 20 percent of the available capacity for HDPE production in the U.S. and Canada. Scrap resin (e.g. off-spec) is produced as a coproduct during this process. A mass basis was used to allocate the credit for each coproduct.

## DESCRIPTION OF TABLES

The average gross energy required to produce HDPE resin is 33.7 million Btu per 1,000 pounds of resin or 78.3 GJ per 1,000 kilograms of resin. Tables 2-1 and 2-2 show the breakdown of energy requirements for the production of HDPE resin by category and source, respectively. Precombustion energy (the energy used to extract and process fuels used for process energy and transportation energy) is included in the results shown in these tables. Table B-1 in the Appendices (separate document) provides the aggregated unit process energy (cradle-to-resin) for the production of HDPE resin. Natural gas and petroleum used as raw material inputs for the production of HDPE, reported as energy of material resource in Table 2-1, are included in the totals for natural gas and petroleum energy in Table 2-2. Petroleum-based fuels (e.g. diesel fuel) are the dominant energy source for transportation. Non-fossil sources, such as hydropower, nuclear and other (geothermal, wind, etc.) shown in Table 2-2 are used to generate purchased electricity along with the fossil fuels.

**Table 2-1**

### Energy by Category for the Production of HDPE Resin

	<u>MMBtu per 1,000 pounds</u>	<u>GJ per 1,000 kilograms</u>
<b>Energy Category</b>		
Process (1)	11.9	27.7
Transportation	0.53	1.22
Energy of Material Resource	21.2	49.4
<b>Total Energy</b>	<b>33.7</b>	<b>78.3</b>
<b>Energy Category (Percent)</b>		
Process	35%	35%
Transportation	2%	2%
Energy of Material Resource	63%	63%
<b>Total</b>	<b>100%</b>	<b>100%</b>

(1) Process energy includes recovered energy, which is shown as a credit.

Source: Franklin Associates, A Division of ERG

Table 2-2

## Energy Profile for the Production of HDPE Resin

	<u>MM Btu per 1,000 pounds</u>	<u>GJ per 1,000 kilograms</u>
<b>Energy Source</b>		
Natural Gas	27.4	63.6
Petroleum	4.86	11.3
Coal	0.98	2.29
Hydropower	0.043	0.10
Nuclear	0.36	0.85
Wood	0	0
Other	0.067	0.16
<b>Recovered Energy (1)</b>	<u>-0.012</u>	<u>-0.028</u>
<b>Total Energy</b>	<b>33.7</b>	<b>78.3</b>
<b>Energy Source (Percent)</b>		
Natural Gas	81%	81%
Petroleum	14%	14%
Coal	3%	3%
Hydropower	0%	0%
Nuclear	1%	1%
Wood	0%	0%
Other	<u>0%</u>	<u>0%</u>
<b>Total</b>	<b>100%</b>	<b>100%</b>

(1) Recovered energy represents the recovery of energy as steam or condensate. Because this energy will be used by other processes, it is shown as a negative entry (credit).

Source: Franklin Associates, A Division of ERG

Table 2-3 shows the weight of solid waste generated during the production of HDPE resin. The process solid waste, those wastes produced directly from the cradle-to-resin processes, includes wastes that are incinerated both for disposal and for waste-to-energy, as well as landfilled. These categories have been provided separately. Solid waste from fuel production and combustion is also presented.

Both process and fuel-related, as well as total, atmospheric emissions are shown in Table 2-4. As defined in the report glossary, process emissions are those released directly from the sequence of processes that are used to extract, transform, fabricate, or otherwise affect changes on a material or product during its life cycle, while fuel-related emissions are those associated with the combustion of fuels used for process energy and transportation energy.

Table 2-3

## Solid Wastes by Weight for the Production of HDPE Resin

	<u>lb per 1,000 pounds</u>	<u>kg per 1,000 kilograms</u>
<b>Solid Wastes By Weight</b>		
Process		
Landfilled	32.1	32.1
Incinerated	3.84	3.84
Waste-to-Energy	0.027	0.027
Fuel	<u>41.1</u>	<u>41.1</u>
<b>Total</b>	<b>77.1</b>	<b>77.1</b>
<b>Weight Percent by Category</b>		
Process		
Landfilled	42%	42%
Incinerated	5%	5%
Waste-to-Energy	0%	0%
Fuel	<u>53%</u>	<u>53%</u>
<b>Total</b>	<b>100 %</b>	<b>100 %</b>

Source: Franklin Associates, A Division of ERG

Table 2-5 provides a greenhouse gas (GHG) summary for the production of HDPE resin. The primary three atmospheric emissions reported in this analysis that contribute to global warming are fossil fuel-derived carbon dioxide, methane, and nitrous oxide. (Non-fossil carbon dioxide emissions, such as those from the burning of wood, are considered part of the natural carbon cycle and are not considered a net contributor to global warming.) The 100-year global warming potential for each of these substances as reported in the Intergovernmental Panel on Climate Change (IPCC) 2007 report are shown in a note at the bottom of Table 2-5. The global warming potential represents the relative global warming contribution of a pound of a particular greenhouse gas compared to a pound of carbon dioxide. The weights of each of the contributing emissions in Table 2-4 are multiplied by their global warming potential and shown in Table 2-5.

Both process and fuel-related, as well as the total waterborne emissions are shown in Table 2-6. Definitions of process and fuel-related emissions are provided in this chapter, as well as in the glossary.

Table 2-4

**Atmospheric Emissions for the Production of HDPE Resin**  
(lb per 1,000 lb or kg per 1,000 kg)  
(page 1 of 2)

	Process emissions	Fuel-related emissions	Total emissions
<b>Atmospheric Emissions</b>			
Carbon Dioxide - Fossil	66.2	1,399	1,465
Methane	6.13	10.9	17.0
Nitrous Oxide	0	0.021	0.021
Carbon Dioxide - Non-Fossil	0	4.31	4.31
Particulates (unspecified)	0.026	0.18	0.20
Particulates (PM10)	0.15	0.12	0.26
Particulates (PM2.5)	0.017	0.080	0.097
Nitrogen Oxides	0.12	2.25	2.37
Sulfur Dioxide	1.84	2.01	3.85
Sulfur Oxides	0.0041	0.54	0.54
VOC (unspecified)	0.73	0.27	1.00
TNMOC (unspecified)	0	0.0055	0.0055
Hydrocarbons (unspecified)	0	0.019	0.02
Carbon Monoxide	0.25	0.84	1.09
1,3 Butadiene	0	9.1E-07	9.1E-07
2,4-Dinitrotoluene	0	6.8E-12	6.8E-12
2-Chloroacetophenone	0	1.7E-10	1.7E-10
5-Methyl Chrysene	0	1.1E-09	1.1E-09
Acenaphthene	0	2.6E-08	2.6E-08
Acenaphthylene	0	1.3E-08	1.3E-08
Acetophenone	0	3.6E-10	3.6E-10
acrolein	0	1.1E-04	1.1E-04
Aldehydes (Acetaldehyde)	0	5.0E-05	5.0E-05
Aldehydes (Formaldehyde)	0	9.1E-04	9.1E-04
Aldehydes (Propionaldehyde)	0	9.2E-09	9.2E-09
Aldehydes (unspecified)	0	4.9E-05	4.9E-05
Ammonia	7.5E-04	1.1E-04	8.6E-04
Ammonia Chloride	0	3.7E-05	3.7E-05
Anthracene	0	1.1E-08	1.1E-08
Antimony	4.3E-07	1.1E-06	1.6E-06
Arsenic	5.4E-08	2.5E-05	2.5E-05
Benzene	0.091	0.026	0.12
Benzo(a)anthracene	0	4.1E-09	4.1E-09
Benzo(a)pyrene	0	1.9E-09	1.9E-09
Benzo(b,j,k)fluoranthene	0	5.6E-09	5.6E-09
Benzo(g,h,i) perylene	0	1.4E-09	1.4E-09
Benzyl Chloride	0	1.7E-08	1.7E-08
Beryllium	0	1.4E-06	1.4E-06
Biphenyl	0	8.6E-08	8.6E-08
Bis(2-ethylhexyl) Phthalate (DEHP)	0	1.8E-09	1.8E-09
Bromoform	0	9.5E-10	9.5E-10
Cadmium	0	9.7E-06	9.7E-06
Carbon Disulfide	0	3.2E-09	3.2E-09
Carbon Tetrachloride	2.9E-07	1.0E-06	1.3E-06
CFC 13 (Methane, trichlorofluoro-)	4.6E-06	5.9E-07	5.2E-06
Chlorobenzene	0	5.3E-10	5.3E-10
Chloroform	0	1.4E-09	1.4E-09
Chlorine	9.9E-05	1.7E-05	1.2E-04
Chromium	1.4E-07	2.3E-05	2.3E-05
Chromium (VI)	0	4.0E-06	4.0E-06

Table 2-4

**Atmospheric Emissions for the Production of HDPE Resin**  
(lb per 1,000 lb or kg per 1,000 kg)  
(page 2 of 2)

	Process emissions	Fuel-related emissions	Total emissions
Chrysene	0	5.1E-09	5.1E-09
Cobalt	0	1.8E-05	1.8E-05
Copper	0	2.8E-07	2.8E-07
Cumene	0	1.3E-10	1.3E-10
Cyanide	0	6.1E-08	6.1E-08
Dimethyl Sulfate	0	1.2E-09	1.2E-09
Dioxins (unspecified)	0	3.7E-08	3.7E-08
Ethyl Chloride	0	1.0E-09	1.0E-09
Ethylbenzene	0.011	0.0031	0.014
Ethylene Dibromide	9.0E-07	1.2E-07	1.0E-06
Ethylene Dichloride	0	9.7E-10	9.7E-10
Fluoranthene	0	3.6E-08	3.6E-08
Fluorene	0	4.6E-08	4.6E-08
Fluorides	0	4.1E-06	4.1E-06
Furans (unspecified)	0	1.3E-10	1.3E-10
Hydrogen Chloride	9.9E-07	0.063	0.063
Hexane	0	1.6E-09	1.6E-09
Hydrogen Fluoride	0	0.0076	0.0076
Indeno(1,2,3-cd)pyrene	0	3.1E-09	3.1E-09
Isophorone (C9H14O)	0	1.4E-08	1.4E-08
Kerosene	0	6.6E-05	6.6E-05
Lead	0	2.9E-05	2.9E-05
Magnesium	0	5.6E-04	5.6E-04
Manganese	0	6.9E-05	6.9E-05
Mercaptan	0	4.9E-06	4.9E-06
Mercury	0	6.1E-06	6.1E-06
Metals (unspecified)	0	9.5E-04	9.5E-04
Methyl Bromide	0	3.9E-09	3.9E-09
Methyl Chloride	0	1.3E-08	1.3E-08
Methyl Ethyl Ketone	0	9.5E-09	9.5E-09
Methyl Hydrazine	0	4.1E-09	4.1E-09
Methyl Methacrylate	0	4.8E-10	4.8E-10
Methyl Tert Butyl Ether (MTBE)	0	8.5E-10	8.5E-10
Methylene Chloride	0	3.3E-05	3.3E-05
Naphthalene	0	9.1E-06	9.1E-06
Nickel	1.2E-06	2.0E-04	2.1E-04
Organics (unspecified)	0.011	3.1E-04	0.011
Perchloroethylene	0	2.4E-06	2.4E-06
Phenanthrene	0	1.4E-07	1.4E-07
Phenols	0	1.1E-05	1.1E-05
Polyaromatic Hydrocarbons (total)	1.2E-05	6.6E-06	1.8E-05
Propylene	0	6.0E-05	6.0E-05
Pyrene	0	1.7E-08	1.7E-08
Radionuclides (unspecified) (1)	0	0.0037	0.0037
Selenium	0	6.8E-05	6.8E-05
Styrene	0	6.1E-10	6.1E-10
Toluene	0.14	0.040	0.18
Trichloroethane	0	4.8E-10	4.8E-10
Vinyl Acetate	0	1.8E-10	1.8E-10
Xylenes	0.082	0.024	0.11
Zinc	0	1.9E-07	1.9E-07
HCFC-22	9.9E-07	0	9.9E-07
Hydrogen	0.0039	0	0.0039
NMVOC, non-methane volatile organic compounds, unspecified origin	0.14	0	0.14
Non-Methane Hydrocarbons	0.51	0	0.51

(1) The units for Radionuclides are Curies per 1,000 lbs of product. The total Radionuclides using metric units are 303,400 kBq per 1,000 kgs of product.

Source: Franklin Associates, A Division of ERG

Table 2-5

**Greenhouse Gas Summary for the Production of HDPE Resin**  
**(lb carbon dioxide equivalents per 1,000 lb HDPE or kg carbon dioxide equivalents per 1,000 kg HDPE)**

	<u>Fuel-related CO2 Equiv.</u>	<u>Process CO2 Equiv.</u>	<u>Total CO2 Equiv.</u>
Carbon Dioxide - Fossil	1,399	66.2	1,465
Methane	272	153	426
Nitrous Oxide	6.23	0	6.23
Methyl Bromide	1.9E-08	0	1.9E-08
Methyl Chloride	2.1E-07	0	2.1E-07
Trichloroethane	6.8E-08	0	6.8E-08
Chloroform	4.3E-08	0	4.3E-08
Methylene Chloride	3.3E-04	0	3.3E-04
Carbon Tetrachloride	0.0014	4.0E-04	0.0018
CFC 13 (Methane, trichlorofluoro-)	0.0067	0.052	0.059
HCFC-22	0	0.0018	0.0018
Total	<u>1,678</u>	<u>220</u>	<u>1,897</u>

Note: The 100 year global warming potentials used in this table are as follows: fossil carbon dioxide--1, methane--25, nitrous oxide--298, methyl bromide--5, methyl chloride--16, trichloroethane--140, chloroform--30, methylene chloride--10, carbon tetrachloride--1400, CFC-013--11,700, HCFC-22--1810, HCFC-123--77, and HFC-134a--1430.

Source: Franklin Associates, A Division of ERG



Table 2-6

**Waterborne Emissions for the Production of HDPE Resin**  
 (lb per 1,000 lb or kg per 1,000 kg)  
 (page 1 of 2)

	Process emissions	Fuel-related emissions	Total emissions
<b>Waterborne Wastes</b>			
1-methylfluorene	2.0E-08	5.6E-09	2.6E-08
2,4 dimethylphenol	8.1E-06	2.1E-06	1.0E-05
2-Hexanone	1.9E-06	4.9E-07	2.4E-06
2-methyl naphthalene	4.4E-06	1.2E-06	5.6E-06
4-methyl-2-pentanone	7.4E-07	2.1E-07	9.4E-07
Acetone	1.8E-06	4.9E-07	2.3E-06
Acid (benzoic)	2.9E-04	7.6E-05	3.7E-04
Acid (hexanoic)	6.0E-05	1.6E-05	7.6E-05
Alkylated Benzenes	5.4E-05	1.4E-05	6.8E-05
Alkylated Fluorenes	3.1E-06	8.1E-07	3.9E-06
Alkylated Naphthalenes	8.8E-07	2.3E-07	1.1E-06
Alkylated Phenanthrenes	3.7E-07	9.5E-08	4.6E-07
Aluminum	0.027	0.0072	0.035
Ammonia	0.0062	0.0012	0.0073
Ammonium	0	2.9E-05	2.9E-05
Antimony	1.7E-05	4.3E-06	2.1E-05
Arsenic	5.4E-05	1.5E-05	6.9E-05
Barium	0.36	0.093	0.45
Benzene	3.1E-04	7.8E-05	3.9E-04
Beryllium	3.4E-06	8.9E-07	4.3E-06
BOD	0.042	0.051	0.093
Boron	9.0E-04	2.4E-04	0.0011
Bromide	0.035	0.0090	0.044
Cadmium	8.4E-06	2.6E-06	1.1E-05
Calcium	0.58	0.15	0.73
Chlorides (methyl chloride)	7.1E-09	2.0E-09	9.0E-09
Chlorides (unspecified)	0	1.88	1.88
Chromium (unspecified)	7.2E-04	1.8E-04	9.0E-04
Cobalt	0.000	1.7E-06	0.000
COD	0.107	0.018	0.125
Copper	7.7E-05	2.8E-05	1.0E-04
Cresols	1.7E-05	4.5E-06	2.2E-05
Cyanide	1.3E-08	3.5E-09	1.6E-08
Cymene	1.8E-08	4.9E-09	2.2E-08
Dibenzofuran	3.3E-08	9.3E-09	4.3E-08
Dibenzothiophene	2.7E-08	7.5E-09	3.5E-08
Dissolved Solids	7.31	1.87	9.19
Ethylbenzene	2.7E-05	4.4E-06	3.1E-05
Fluorine/Fluorides	1.5E-06	4.8E-04	4.8E-04
Hydrocarbons	0.0010	1.5E-05	0.0010
Iron	0.049	0.015	0.064
Lead	1.4E-04	3.9E-05	1.8E-04
Lithium	0.14	0.041	0.18
Magnesium	0.12	0.030	0.15
Manganese	1.7E-04	7.0E-04	8.7E-04
Mercury	3.0E-07	8.7E-08	3.9E-07
Methyl Ethyl Ketone (MEK)	1.4E-08	3.9E-09	1.8E-08
Molybdenum	6.6E-06	1.7E-06	8.3E-06

Table 2-6

**Waterborne Emissions for the Production of HDPE Resin**  
**(lb per 1,000 lb or kg per 1,000 kg)**  
 (page 2 of 2)

	Process emissions	Fuel-related emissions	Total emissions
Naphthalene	5.2E-06	1.4E-06	6.6E-06
Nickel	6.6E-05	1.7E-05	8.3E-05
Nitrates	0	7.3E-05	7.3E-05
Nitrogen (ammonia)	0	2.6E-05	2.6E-05
Oil	0.012	0.0017	0.013
Pentamethyl benzene	1.3E-08	3.7E-09	1.7E-08
Phenanthrene	2.3E-07	6.0E-08	2.9E-07
Phenol/Phenolic Compounds	0.0011	2.8E-05	0.0012
Radionuclides (unspecified) (1)	0	5.2E-08	5.2E-08
Selenium	3.5E-06	1.1E-05	1.5E-05
Silver	3.5E-04	9.1E-05	4.4E-04
Sodium	1.66	0.43	2.09
Strontium	0.016	0.0041	0.020
Sulfates	0.012	0.051	0.063
Sulfides	3.9E-05	5.1E-06	4.4E-05
Sulfur	7.2E-04	1.9E-04	9.2E-04
Surfactants	1.4E-04	3.7E-05	1.8E-04
Suspended Solids	2.97	0.77	3.75
Thallium	3.5E-06	9.1E-07	4.4E-06
Tin	6.6E-05	1.7E-05	8.3E-05
Titanium	2.5E-04	6.6E-05	3.2E-04
Toluene	3.8E-04	7.2E-05	4.5E-04
Total Alkalinity	0.013	0.0033	0.016
Total Biphenyls	3.5E-06	9.1E-07	4.4E-06
Total Dibenzo-thiophenes	1.1E-08	2.8E-09	1.4E-08
Vanadium	1.9E-05	3.5E-06	2.2E-05
Xylenes	1.5E-04	3.7E-05	1.8E-04
Yttrium	1.9E-06	5.1E-07	2.4E-06
Zinc	6.8E-04	1.7E-04	8.5E-04
Furans	1.0E-06	0	1.0E-06
Lead 210	3.0E-14	0	3.0E-14
n-Decane	8.4E-06	0	8.4E-06
n-Docosane	1.9E-07	0	1.9E-07
n-Dodecane	1.6E-05	0	1.6E-05
n-Eicosane	4.3E-06	0	4.3E-06
n-Hexacosane	1.2E-07	0	1.2E-07
n-Hexadecane	1.7E-05	0	1.7E-05
n-Octadecane	4.3E-06	0	4.3E-06
Phosphorus	1.0E-04	0	1.0E-04
Radium 226	1.0E-11	0	1.0E-11
Radium 228	5.3E-14	0	5.3E-14
Styrene	9.9E-07	0	9.9E-07
TOC	0.0010	0	0.0010

(1) The units for Radionuclides are Curies per 1,000 lbs of product. The total Radionuclides using metric units are 4.24 kBq per 1,000 kgs of product.

Source: Franklin Associates, A Division of ERG

## CHAPTER 3

## CRADLE-TO-RESIN LIFE CYCLE INVENTORY RESULTS FOR LDPE RESIN

This chapter presents LCI results for the production of low-density polyethylene (LDPE) resin (cradle-to-resin). The results are given on the bases of 1,000 pounds and 1,000 kilograms of LDPE resin. Figure 3-1 presents the flow diagram for the production of LDPE resin. Process descriptions and individual process tables for each box shown in the flow diagram can be found in Appendix C of the Appendices (separate document).

Primary data was collected for olefins and LDPE resin production. A weighted average using production quantities was calculated from the olefins production data collected from three leading producers (8 thermal cracking units) in North America. As of 2003, there were 16 olefin producers and at least 29 olefin plants in the U.S. The captured production amount is approximately 30 percent of the available capacity for olefin production. Numerous coproduct streams are produced from the olefins hydrocracker. Fuel gas and off-gas were two of the coproducts produced that were exported to another process for fuel. When these fuel coproducts are exported from the hydrocracker, they carry with them the allocated share of the inputs and outputs for their production. The separate appendices provide an in-depth discussion of this allocation. A mass basis was used to allocate the credit to the remaining material coproducts.

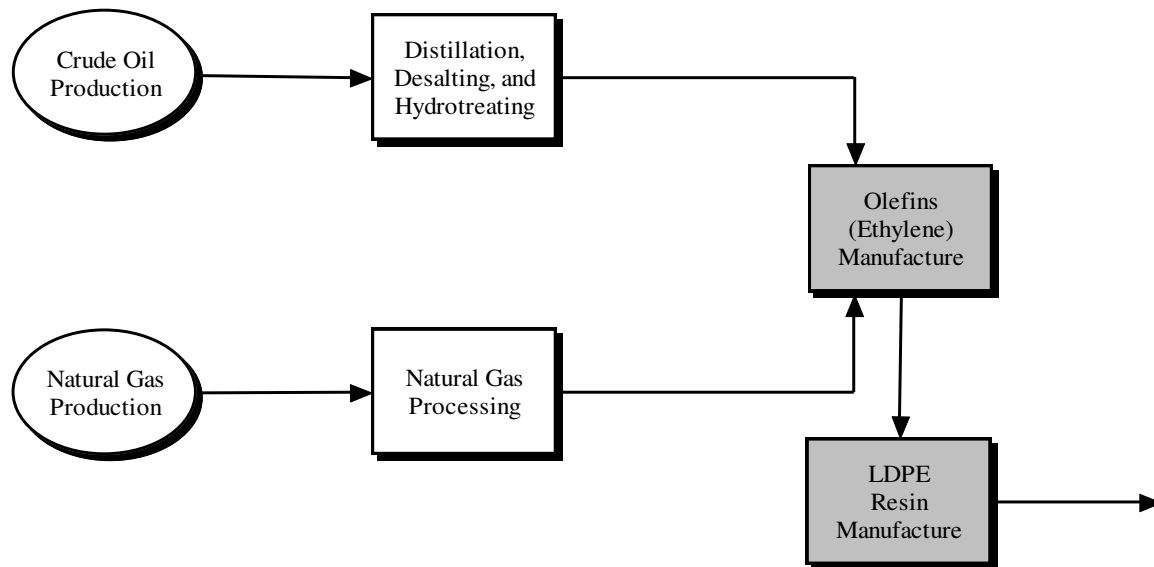

Figure 3-1. Flow diagram for the manufacture of virgin low-density polyethylene (LDPE) resin. Shaded boxes represent partial or complete data provided by manufacturers specifically for this analysis.

A weighted average using production amounts was calculated from the LDPE production data from seven plants collected from three leading producers in North America. As of 2003, there were 8 LDPE producers and 15 LDPE plants in the U.S. The captured production amount is approximately 30 percent of the 2003 production amount for LDPE production in the U.S. and Canada. Scrap resin (e.g. off-spec) and steam are produced as coproducts during this process. A mass basis was used to allocate the credit for scrap, while the energy amount for the steam was reported separately as recovered energy.

## DESCRIPTION OF TABLES

The average gross energy required to produce LDPE resin is 35.9 million Btu per 1,000 pounds of resin or 83.6 GJ per 1,000 kilograms of resin. Tables 3-1 and 3-2 show the breakdown of energy requirements for the production of LDPE resin by category and source, respectively. Precombustion energy (the energy used to extract and process fuels used for process energy and transportation energy) is included in the results shown in these tables. Table C-1 in the Appendices (separate document) provides the aggregated unit process energy (cradle-to-resin) for the production of LDPE resin. Natural gas and petroleum used as raw material inputs for the production of LDPE, reported as energy of material resource in Table 3-1, are included in the totals for natural gas and petroleum energy in Table 3-2. Petroleum-based fuels (e.g. diesel fuel) are the dominant energy source for transportation. Non-fossil sources, such as hydropower, nuclear and other (geothermal, wind, etc.) shown in Table 3-2 are used to generate purchased electricity along with the fossil fuels.

**Table 3-1**

### Energy by Category for the Production of LDPE Resin

	<u>MMBtu per 1,000 pounds</u>	<u>GJ per 1,000 kilograms</u>
<b>Energy Category</b>		
Process (1)	13.8	32.1
Transportation	0.54	1.25
Energy of Material Resource	<u>21.6</u>	<u>50.3</u>
<b>Total Energy</b>	<b>35.9</b>	<b>83.6</b>
<b>Energy Category (Percent)</b>		
Process	38%	38%
Transportation	1%	1%
Energy of Material Resource	<u>60%</u>	<u>60%</u>
<b>Total</b>	<b>100%</b>	<b>100%</b>

(1) Process energy includes recovered energy, which is shown as a credit.

Source: Franklin Associates, A Division of ERG

Table 3-2

## Energy Profile for the Production of LDPE Resin

	<u>MM Btu per 1,000 pounds</u>	<u>GJ per 1,000 kilograms</u>
<b>Energy Source</b>		
Natural Gas	29.7	69.2
Petroleum	4.86	11.3
Coal	1.03	2.40
Hydropower	0.045	0.10
Nuclear	0.38	0.89
Wood	0	0
Other	0.070	0.16
<b>Recovered Energy (1)</b>	<u>-0.18</u>	<u>-0.43</u>
<b>Total Energy</b>	<b>35.9</b>	<b>83.6</b>
<b>Energy Source (Percent)</b>		
Natural Gas	82%	82%
Petroleum	13%	13%
Coal	3%	3%
Hydropower	0%	0%
Nuclear	1%	1%
Wood	0%	0%
Other	<u>0%</u>	<u>0%</u>
<b>Total</b>	<b>100%</b>	<b>100%</b>

(1) Recovered energy represents the recovery of energy as steam or condensate. Because this energy will be used by other processes, it is shown as a negative entry (credit).

Source: Franklin Associates, A Division of ERG

Table 3-3 shows the weight of solid waste generated during the production of LDPE resin. The process solid waste, those wastes produced directly from the cradle-to-resin processes, includes wastes that are incinerated both for disposal and for waste-to-energy, as well as landfilled. These categories have been provided separately. Solid waste from fuel production and combustion is also presented.

Both process and fuel-related, as well as total, atmospheric emissions are shown in Table 3-4. As defined in the report glossary, process emissions are those released directly from the sequence of processes that are used to extract, transform, fabricate, or otherwise affect changes on a material or product during its life cycle, while fuel-related emissions are those associated with the combustion of fuels used for process energy and transportation energy.

Table 3-3

## Solid Wastes by Weight for the Production of LDPE Resin

	lb per 1,000 pounds	kg per 1,000 kilograms
<b>Solid Wastes By Weight</b>		
Process		
Landfilled	32.3	32.3
Incinerated	3.89	3.89
Waste-to-Energy	0.024	0.024
Fuel	44.9	44.9
<b>Total</b>	<b>81.2</b>	<b>81.2</b>
<b>Weight Percent by Category</b>		
Process		
Landfilled	40%	40%
Incinerated	5%	5%
Waste-to-Energy	0%	0%
Fuel	55%	55%
<b>Total</b>	<b>100 %</b>	<b>100 %</b>

Source: Franklin Associates, A Division of ERG

Table 3-5 provides a greenhouse gas (GHG) summary for the production of LDPE resin. The primary three atmospheric emissions reported in this analysis that contribute to global warming are fossil fuel-derived carbon dioxide, methane, and nitrous oxide. (Non-fossil carbon dioxide emissions, such as those from the burning of wood, are considered part of the natural carbon cycle and are not considered a net contributor to global warming.) The 100-year global warming potential for each of these substances as reported in the Intergovernmental Panel on Climate Change (IPCC) 2007 report are shown in a note at the bottom of Table 3-5. The global warming potential represents the relative global warming contribution of a pound of a particular greenhouse gas compared to a pound of carbon dioxide. The weights of each of the contributing emissions in Table 3-4 are multiplied by their global warming potential and shown in Table 3-5.

Both process and fuel-related, as well as the total waterborne emissions are shown in Table 3-6. Definitions of process and fuel-related emissions are provided in this chapter, as well as in the glossary.

Table 3-4

**Atmospheric Emissions for the Production of LDPE Resin**  
**(lb per 1,000 lb or kg per 1,000 kg)**  
 (page 1 of 2)

	Process emissions	Fuel-related emissions	Total emissions
<b>Atmospheric Emissions</b>			
Carbon Dioxide - Fossil	77.4	1,656	1,733
Methane	6.24	12.1	18.4
Nitrous Oxide	0.0010	0.026	0.027
Carbon Dioxide - Non-Fossil	0	4.53	4.53
Particulates (unspecified)	0.054	0.19	0.24
Particulates (PM10)	0.13	0.13	0.26
Particulates (PM2.5)	0.010	0.088	0.099
Nitrogen Oxides	0.092	2.42	2.51
Sulfur Dioxide	1.87	2.25	4.12
Sulfur Oxides	0.0042	0.51	0.51
VOC (unspecified)	0.75	0.35	1.09
TNMOC (unspecified)	0	0.0058	0.0058
Hydrocarbons (unspecified)	0	0.017	0.017
Carbon Monoxide	0.10	0.99	1.09
1,3 Butadiene	0	9.8E-07	9.8E-07
2,4-Dinitrotoluene	0	7.1E-12	7.1E-12
2-Chloroacetophenone	0	1.8E-10	1.8E-10
5-Methyl Chrysene	0	1.2E-09	1.2E-09
Acenaphthene	0	2.7E-08	2.7E-08
Acenaphthylene	0	1.3E-08	1.3E-08
Acetophenone	0	3.8E-10	3.8E-10
acrolein	0	1.1E-04	1.1E-04
Aldehydes (Acetaldehyde)	0	5.3E-05	5.3E-05
Aldehydes (Formaldehyde)	0	0.0011	0.0011
Aldehydes (Propionaldehyde)	0	9.7E-09	9.7E-09
Aldehydes (unspecified)	0	5.1E-05	5.1E-05
Ammonia	7.7E-04	9.4E-05	8.6E-04
Ammonia Chloride	0	3.9E-05	3.9E-05
Anthracene	0	1.1E-08	1.1E-08
Antimony	4.4E-07	1.2E-06	1.6E-06
Arsenic	5.5E-08	2.6E-05	2.6E-05
Benzene	0.093	0.035	0.13
Benzo(a)anthracene	0	4.3E-09	4.3E-09
Benzo(a)pyrene	0	2.0E-09	2.0E-09
Benzo(b,j,k)fluoranthene	0	5.9E-09	5.9E-09
Benzo(g,h,i) perylene	0	1.4E-09	1.4E-09
Benzyl Chloride	0	1.8E-08	1.8E-08
Beryllium	0	1.4E-06	1.4E-06
Biphenyl	0	9.1E-08	9.1E-08
Bis(2-ethylhexyl) Phthalate (DEHP)	0	1.9E-09	1.9E-09
Bromoform	0	9.9E-10	9.9E-10
Cadmium	0	1.2E-05	1.2E-05
Carbon Disulfide	0	3.3E-09	3.3E-09
Carbon Tetrachloride	2.9E-07	1.1E-06	1.4E-06
CFC 13 (Methane, trichlorofluoro-)	4.7E-06	5.1E-07	5.2E-06
Chlorobenzene	0	5.6E-10	5.6E-10
Chloroform	0	1.5E-09	1.5E-09
Chlorine	1.0E-04	1.8E-05	1.2E-04
Chromium	1.4E-07	2.6E-05	2.6E-05

Table 3-4

**Atmospheric Emissions for the Production of LDPE Resin**  
(lb per 1,000 lb or kg per 1,000 kg)  
(page 2 of 2)

	Process emissions	Fuel-related emissions	Total emissions
Chromium (VI)	0	4.2E-06	4.2E-06
Chrysene	0	5.3E-09	5.3E-09
Cobalt	0	1.6E-05	1.6E-05
Copper	0	3.0E-07	3.0E-07
Cumene	0	1.3E-10	1.3E-10
Cyanide	0	6.4E-08	6.4E-08
Dimethyl Sulfate	0	1.2E-09	1.2E-09
Dioxins (unspecified)	0	3.9E-08	3.9E-08
Ethyl Chloride	0	1.1E-09	1.1E-09
Ethylbenzene	0.011	0.0041	0.015
Ethylene Dibromide	9.1E-07	9.9E-08	1.0E-06
Ethylene Dichloride	0	1.0E-09	1.0E-09
Fluoranthene	0	3.8E-08	3.8E-08
Fluorene	0	4.9E-08	4.9E-08
Fluorides	0	4.3E-06	4.3E-06
Furans (unspecified)	0	1.3E-10	1.3E-10
Hydrogen Chloride	1.0E-06	0.066	0.066
Hexane	0	1.7E-09	1.7E-09
Hydrogen Fluoride	0	0.0080	0.0080
Indeno(1,2,3-cd)pyrene	0	3.3E-09	3.3E-09
Isophorone (C9H14O)	0	1.5E-08	1.5E-08
Kerosene	0	6.9E-05	6.9E-05
Lead	0	3.0E-05	3.0E-05
Magnesium	0	5.9E-04	5.9E-04
Manganese	0	7.1E-05	7.1E-05
Mercaptan	0	5.1E-06	5.1E-06
Mercury	0	6.8E-06	6.8E-06
Metals (unspecified)	0	0.0010	0.0010
Methyl Bromide	0	4.1E-09	4.1E-09
Methyl Chloride	0	1.3E-08	1.3E-08
Methyl Ethyl Ketone	0	9.9E-09	9.9E-09
Methyl Hydrazine	0	4.3E-09	4.3E-09
Methyl Methacrylate	0	5.1E-10	5.1E-10
Methyl Tert Butyl Ether (MTBE)	0	8.9E-10	8.9E-10
Methylene Chloride	0	3.2E-05	3.2E-05
Naphthalene	0	9.8E-06	9.8E-06
Nickel	1.2E-06	1.6E-04	1.7E-04
Organics (unspecified)	0.051	3.3E-04	0.051
Perchloroethylene	0	2.4E-06	2.4E-06
Phenanthrene	0	1.4E-07	1.4E-07
Phenols	0	8.9E-06	8.9E-06
Polyaromatic Hydrocarbons (total)	1.2E-05	6.8E-06	1.9E-05
Propylene	0	6.5E-05	6.5E-05
Pyrene	0	1.8E-08	1.8E-08
Radionuclides (unspecified) (1)	0	0.0039	0.0039
Selenium	0	7.1E-05	7.1E-05
Styrene	0	6.4E-10	6.4E-10
Toluene	0.14	0.054	0.20
Trichloroethane	0	5.1E-10	5.1E-10
Vinyl Acetate	0	1.9E-10	1.9E-10
Xylenes	0.083	0.031	0.11
Zinc	0	2.0E-07	2.0E-07
HCFC-22	0.0010	0	0.0010
Hydrogen	0.0040	0	0.0040
NM VOC, non-methane volatile organic compounds, unspecified origin	0.15	0	0.15
Non-Methane Hydrocarbons	0.96	0	0.96

(1) The units for Radionuclides are Curies per 1,000 lbs of product. The total Radionuclides using metric units are 318,950 kBq per 1,000 kgs of product.

Source: Franklin Associates, A Division of ERG



Table 3-5

**Greenhouse Gas Summary for the Production of LDPE Resin**  
**(lb carbon dioxide equivalents per 1,000 lb LDPE or kg carbon dioxide equivalents per 1,000 kg LDPE)**

	<u>Fuel-related CO2 Equiv.</u>	<u>Process CO2 Equiv.</u>	<u>Total CO2 Equiv.</u>
Carbon Dioxide - Fossil	1,656	77.4	1,733
Methane	304	156	460
Nitrous Oxide	7.67	0.30	7.97
Methyl Bromide	2.0E-08	0	2.0E-08
Methyl Chloride	2.2E-07	0	2.2E-07
Trichloroethane	7.1E-08	0	7.1E-08
Chloroform	4.5E-08	0	4.5E-08
Methylene Chloride	3.2E-04	0	3.2E-04
Carbon Tetrachloride	0.0015	4.1E-04	0.0019
CFC 13 (Methane, trichlorofluor	0.0057	0.053	0.058
HCFC-22	0	1.81	1.81
Total	<u>1,968</u>	<u>234</u>	<u>2,201</u>

Note: The 100 year global warming potentials used in this table are as follows: fossil carbon dioxide--1, methane--25, nitrous oxide--298, methyl bromide--5, methyl chloride--16, trichloroethane--140, chloroform--30, methylene chloride--10, carbon tetrachloride--1400, CFC-013--11,700, HCFC-22--1810, HCFC-123--77, and HFC-134a--1430.

Source: Franklin Associates, A Division of ERG

Table 3-6

**Waterborne Emissions for the Production of LDPE Resin**  
 (lb per 1,000 lb or kg per 1,000 kg)  
 (page 1 of 2)

	Process emissions	Fuel-related emissions	Total emissions
<b>Waterborne Wastes</b>			
1-methylfluorene	2.0E-08	7.3E-09	2.8E-08
2,4 dimethylphenol	8.2E-06	2.7E-06	1.1E-05
2-Hexanone	1.9E-06	6.3E-07	2.5E-06
2-methyl naphthalene	4.5E-06	1.5E-06	6.0E-06
4-methyl-2-pentanone	7.5E-07	2.7E-07	1.0E-06
Acetone	1.8E-06	6.4E-07	2.4E-06
Acid (benzoic)	3.0E-04	9.9E-05	4.0E-04
Acid (hexanoic)	6.2E-05	2.0E-05	8.2E-05
Alkylated Benzenes	5.5E-05	1.8E-05	7.3E-05
Alkylated Fluorenes	3.2E-06	1.0E-06	4.2E-06
Alkylated Naphthalenes	9.0E-07	3.0E-07	1.2E-06
Alkylated Phenanthrenes	3.7E-07	1.2E-07	5.0E-07
Aluminum	0.027	0.0092	0.036
Ammonia	0.0063	0.0013	0.0076
Ammonium	0	3.1E-05	3.1E-05
Antimony	1.7E-05	5.5E-06	2.2E-05
Arsenic	5.5E-05	1.9E-05	7.4E-05
Barium	0.36	0.12	0.48
Benzene	3.2E-04	1.0E-04	4.2E-04
Beryllium	3.5E-06	1.1E-06	4.6E-06
BOD	0.047	0.055	0.10
Boron	9.2E-04	3.0E-04	0.0012
Bromide	0.036	0.012	0.047
Cadmium	8.6E-06	3.3E-06	1.2E-05
Calcium	0.59	0.19	0.79
Chlorides (methyl chloride)	7.2E-09	2.6E-09	9.8E-09
Chlorides (unspecified)	1.0E-04	2.42	2.42
Chromium (unspecified)	7.2E-04	2.4E-04	9.5E-04
Cobalt	6.5E-06	2.2E-06	8.6E-06
COD	0.21	0.021	0.23
Copper	7.8E-05	3.4E-05	1.1E-04
Cresols	1.8E-05	5.8E-06	2.3E-05
Cyanide	1.3E-08	4.6E-09	1.8E-08
Cymene	1.8E-08	6.4E-09	2.4E-08
Dibenzofuran	3.4E-08	1.2E-08	4.6E-08
Dibenzothiophene	2.8E-08	9.9E-09	3.7E-08
Dissolved Solids	7.40	2.40	9.81
Ethylbenzene	2.7E-05	5.6E-06	3.3E-05
Fluorine/Fluorides	1.5E-06	5.0E-04	5.0E-04
Hydrocarbons	0	1.9E-05	1.9E-05
Iron	0.050	0.019	0.068
Lead	1.5E-04	4.9E-05	2.0E-04
Lithium	0.14	0.054	0.20
Magnesium	0.12	0.039	0.16
Manganese	1.7E-04	7.5E-04	9.2E-04
Mercury	3.1E-07	1.1E-07	4.2E-07
Methyl Ethyl Ketone (MEK)	1.4E-08	5.2E-09	2.0E-08
Molybdenum	6.7E-06	2.2E-06	9.0E-06

Table 3-6

**Waterborne Emissions for the Production of LDPE Resin**  
(lb per 1,000 lb or kg per 1,000 kg)  
(page 2 of 2)

	Process emissions	Fuel-related emissions	Total emissions
Naphthalene	5.3E-06	1.8E-06	7.1E-06
Nickel	6.7E-05	2.2E-05	8.9E-05
Nitrates	0	7.7E-05	7.7E-05
Nitrogen (ammonia)	0	2.7E-05	2.7E-05
Oil	0.0085	0.0020	0.011
Pentamethyl benzene	1.3E-08	4.8E-09	1.8E-08
Phenanthrene	2.3E-07	7.8E-08	3.1E-07
Phenol/Phenolic Compounds	0.0011	3.4E-05	0.0012
Radionuclides (unspecified) (1)	0	5.5E-08	5.5E-08
Selenium	3.6E-06	1.2E-05	1.6E-05
Silver	3.6E-04	1.2E-04	4.8E-04
Sodium	1.69	0.55	2.24
Strontium	0.016	0.0053	0.021
Sulfates	0.012	0.054	0.066
Sulfides	4.0E-05	4.3E-06	4.4E-05
Sulfur	7.4E-04	2.5E-04	9.8E-04
Surfactants	1.5E-04	4.8E-05	1.9E-04
Suspended Solids	2.99	0.99	3.98
Thallium	3.5E-06	1.2E-06	4.7E-06
Tin	6.7E-05	2.2E-05	8.9E-05
Titanium	2.6E-04	8.5E-05	3.4E-04
Toluene	3.8E-04	9.2E-05	4.8E-04
Total Alkalinity	0.013	0.0043	0.017
Total Biphenyls	3.5E-06	1.2E-06	4.7E-06
Total Dibenzo-thiophenes	1.1E-08	3.6E-09	1.5E-08
Vanadium	1.9E-05	3.8E-06	2.3E-05
Xylenes	1.5E-04	4.8E-05	2.0E-04
Yttrium	2.0E-06	6.5E-07	2.6E-06
Zinc	6.2E-04	2.2E-04	8.4E-04
CFC-11	1.0E-04	0	1.0E-04
Isopropyl alcohol	1.0E-04	0	1.0E-04
Lead 210	3.0E-14	0	3.0E-14
n-Decane	8.5E-06	0	8.5E-06
n-Docosane	1.9E-07	0	1.9E-07
n-Dodecane	1.6E-05	0	1.6E-05
n-Eicosane	4.4E-06	0	4.4E-06
n-Hexacosane	1.2E-07	0	1.2E-07
n-Hexadecane	1.8E-05	0	1.8E-05
n-Octadecane	4.4E-06	0	4.4E-06
Phosphorus	1.0E-04	0	1.0E-04
Radium 226	1.1E-11	0	1.1E-11
Radium 228	5.4E-14	0	5.4E-14
Styrene	1.0E-06	0	1.0E-06
Tetradecane	6.9E-06	0	6.9E-06
TOC	0.0010	0	0.0010

(1) The units for Radionuclides are Curies per 1,000 lbs of product. The total Radionuclides using metric units are 4.45 kBq per 1,000 kgs of product.

Source: Franklin Associates, A Division of ERG

## CHAPTER 4

CRADLE-TO-RESIN LIFE CYCLE INVENTORY  
RESULTS FOR LLDPE RESIN

This chapter presents LCI results for the production of linear low-density polyethylene (LLDPE) resin (cradle-to-resin). The results are given on the bases of 1,000 pounds and 1,000 kilograms of LLDPE resin. Figure 4-1 presents the flow diagram for the production of LLDPE resin. Process descriptions and individual process tables for each box shown in the flow diagram can be found in Appendix D of the Appendices (separate document).

Primary data was collected for olefins and LLDPE resin production. A weighted average using production quantities was calculated from the olefins production data collected from three leading producers (8 thermal cracking units) in North America. As of 2003, there were 16 olefin producers and at least 29 olefin plants in the U.S. The captured production amount is approximately 30 percent of the available capacity for olefin production. Numerous coproduct streams are produced from the olefins hydrocracker. Fuel gas and off-gas were two of the coproducts produced that were exported to another process for fuel. When these fuel coproducts are exported from the hydrocracker, they carry with them the allocated share of the inputs and outputs for their production. The separate appendices provide an in-depth discussion of this allocation. A mass basis was used to allocate the credit to the remaining material coproducts.

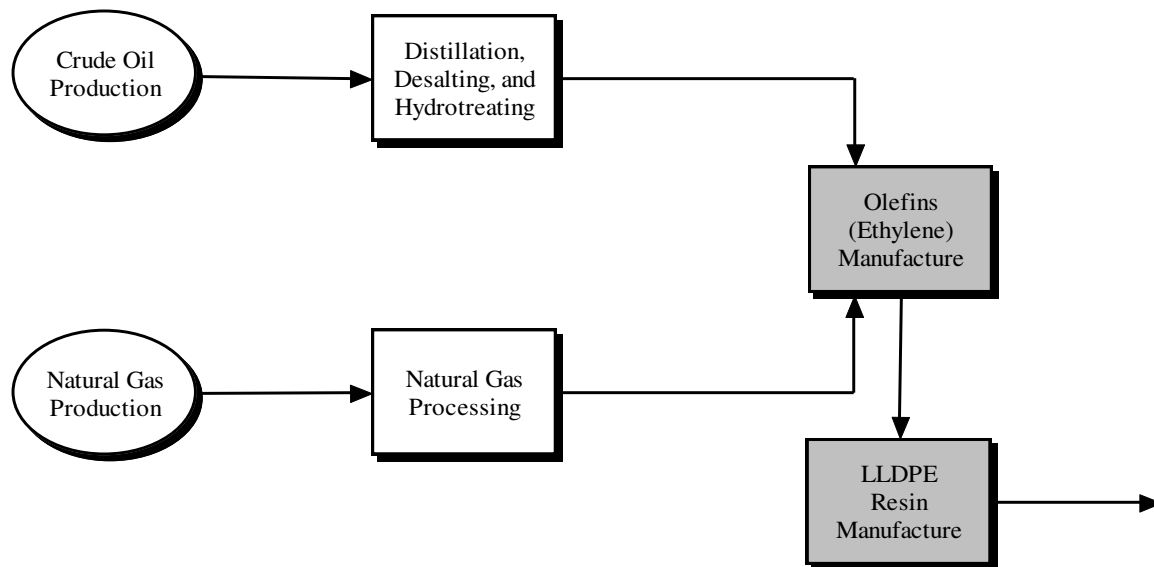

Figure 4-1. Flow diagram for the manufacture of virgin linear low-density (LLDPE) resin. Shaded boxes represent partial or complete data provided by manufacturers specifically for this analysis.

A weighted average using production amounts was calculated from the LLDPE production data from five plants collected from three leading producers in North America. As of 2003, there were 11 LLDPE producers and 24 LLDPE plants in the U.S. The captured production amount is approximately 45 percent of the 2003 production amount for LLDPE production in the U.S. and Canada. Scrap resin (e.g. off-spec) is produced as a coproduct during this process. A mass basis was used to allocate the credit for each coproduct.

## DESCRIPTION OF TABLES

The average gross energy required to produce LLDPE resin is 33.5 million Btu per 1,000 pounds of resin or 78.0 GJ per 1,000 kilograms of resin. Tables 4-1 and 4-2 show the breakdown of energy requirements for the production of LLDPE resin by category and source, respectively. Precombustion energy (the energy used to extract and process fuels used for process energy and transportation energy) is included in the results shown in these tables. Table D-1 in the Appendices (separate document) provides the aggregated unit process energy (cradle-to-resin) for the production of LLDPE resin. Natural gas and petroleum used as raw material inputs for the production of LLDPE, reported as energy of material resource in Table 4-1, are included in the totals for natural gas and petroleum energy in Table 4-2. Petroleum-based fuels (e.g. diesel fuel) are the dominant energy source for transportation. Non-fossil sources, such as hydropower, nuclear and other (geothermal, wind, etc.) shown in Table 4-2 are used to generate purchased electricity along with the fossil fuels.

**Table 4-1**

### Energy by Category for the Production of LLDPE Resin

	<u>MMBtu per 1,000 pounds</u>	<u>GJ per 1,000 kilograms</u>
<b>Energy Category</b>		
Process (1)	11.6	26.9
Transportation	0.53	1.24
Energy of Material Resource	<u>21.4</u>	<u>49.8</u>
<b>Total Energy</b>	<b>33.5</b>	<b>78.0</b>
<b>Energy Category (Percent)</b>		
Process	35%	35%
Transportation	2%	2%
Energy of Material Resource	<u>64%</u>	<u>64%</u>
<b>Total</b>	<b>100%</b>	<b>100%</b>

(1) Process energy includes recovered energy, which is shown as a credit.

Source: Franklin Associates, A Division of ERG

**Table 4-2**  
**Energy Profile for the Production of LLDPE Resin**

	<u>MM Btu per 1,000 pounds</u>	<u>GJ per 1,000 kilograms</u>
<b>Energy Source</b>		
Natural Gas	27.4	63.8
Petroleum	4.83	11.2
Coal	0.85	1.99
Hydropower	0.037	0.09
Nuclear	0.32	0.74
Wood	0	0
Other	0.058	0.13
<b>Recovered Energy (1)</b>	<u>-0.01</u>	<u>-0.03</u>
<b>Total Energy</b>	<b>33.5</b>	<b>78.0</b>
<b>Energy Source (Percent)</b>		
Natural Gas	82%	82%
Petroleum	14%	14%
Coal	3%	3%
Hydropower	0%	0%
Nuclear	1%	1%
Wood	0%	0%
Other	<u>0%</u>	<u>0%</u>
<b>Total</b>	<b>100%</b>	<b>100%</b>

(1) Recovered energy represents the recovery of energy as steam or condensate. Because this energy will be used by other processes, it is shown as a negative entry (credit).

Source: Franklin Associates, A Division of ERG

Table 4-3 shows the weight of solid waste generated during the production of LLDPE resin. The process solid waste, those wastes produced directly from the cradle-to-resin processes, includes wastes that are incinerated both for disposal and for waste-to-energy, as well as landfilled. These categories have been provided separately. Solid waste from fuel production and combustion is also presented.

Both process and fuel-related, as well as total, atmospheric emissions are shown in Table 4-4. As defined in the report glossary, process emissions are those released directly from the sequence of processes that are used to extract, transform, fabricate, or otherwise affect changes on a material or product during its life cycle, while fuel-related emissions are those associated with the combustion of fuels used for process energy and transportation energy.

Table 4-3

## Solid Wastes by Weight for the Production of LLDPE Resin

	<u>lb per 1,000 pounds</u>	<u>kg per 1,000 kilograms</u>
<b>Solid Wastes By Weight</b>		
Process		
Landfilled	32.3	32.3
Incinerated	3.75	3.75
Waste-to-Energy	0.11	0.11
Fuel	<u>36.5</u>	<u>36.5</u>
<b>Total</b>	<b><u>72.7</u></b>	<b><u>72.7</u></b>
<b>Weight Percent by Category</b>		
Process		
Landfilled	44%	44%
Incinerated	5%	5%
Waste-to-Energy	0%	0%
Fuel	<u>50%</u>	<u>50%</u>
<b>Total</b>	<b><u>100 %</u></b>	<b><u>100 %</u></b>

Source: Franklin Associates, A Division of ERG

Table 4-5 provides a greenhouse gas (GHG) summary for the production of LLDPE resin. The primary three atmospheric emissions reported in this analysis that contribute to global warming are fossil fuel-derived carbon dioxide, methane, and nitrous oxide. (Non-fossil carbon dioxide emissions, such as those from the burning of wood, are considered part of the natural carbon cycle and are not considered a net contributor to global warming.) The 100-year global warming potential for each of these substances as reported in the Intergovernmental Panel on Climate Change (IPCC) 2007 report are shown in a note at the bottom of Table 4-5. The global warming potential represents the relative global warming contribution of a pound of a particular greenhouse gas compared to a pound of carbon dioxide. The weights of each of the contributing emissions in Table 4-4 are multiplied by their global warming potential and shown in Table 4-5.

Both process and fuel-related, as well as the total waterborne emissions are shown in Table 4-6. Definitions of process and fuel-related emissions are provided in this chapter, as well as in the glossary.

Table 4-4

**Atmospheric Emissions for the Production of LLDPE Resin**  
(lb per 1,000 lb or kg per 1,000 kg)  
(page 1 of 2)

	Process emissions	Fuel-related emissions	Total emissions
<b>Atmospheric Emissions</b>			
Carbon Dioxide - Fossil	118	1,347	1,465
Methane	6.18	10.8	17.0
Nitrous Oxide	0.017	0.020	0.037
Carbon Dioxide - Non-Fossil	0	3.73	3.73
Particulates (unspecified)	0.018	0.16	0.17
Particulates (PM10)	0.12	0.11	0.23
Particulates (PM2.5)	0.015	0.075	0.090
Nitrogen Oxides	0.12	2.13	2.25
Sulfur Dioxide	1.85	1.80	3.66
Sulfur Oxides	0.0043	0.51	0.51
VOC (unspecified)	0.74	0.27	1.00
TNMOC (unspecified)	0	0.0048	0.0048
Hydrocarbons (unspecified)	0	0.017	0.017
Carbon Monoxide	0.19	0.83	1.02
1,3 Butadiene	0	9.1E-07	9.1E-07
2,4-Dinitrotoluene	0	5.9E-12	5.9E-12
2-Chloroacetophenone	0	1.5E-10	1.5E-10
5-Methyl Chrysene	0	9.7E-10	9.7E-10
Acenaphthene	0	2.3E-08	2.3E-08
Acenaphthylene	0	1.1E-08	1.1E-08
Acetophenone	0	3.2E-10	3.2E-10
acrolein	0	9.4E-05	9.4E-05
Aldehydes (Acetaldehyde)	0	4.7E-05	4.7E-05
Aldehydes (Formaldehyde)	0	8.8E-04	8.8E-04
Aldehydes (Propionaldehyde)	0	8.0E-09	8.0E-09
Aldehydes (unspecified)	0	4.2E-05	4.2E-05
Ammonia	7.6E-04	9.5E-05	8.5E-04
Ammonia Chloride	0	3.2E-05	3.2E-05
Anthracene	0	9.3E-09	9.3E-09
Antimony	4.3E-07	9.9E-07	1.4E-06
Arsenic	5.5E-08	2.2E-05	2.2E-05
Benzene	0.092	0.026	0.12
Benzo(a)anthracene	0	3.5E-09	3.5E-09
Benzo(a)pyrene	0	1.7E-09	1.7E-09
Benzo(b,j,k)fluoranthene	0	4.9E-09	4.9E-09
Benzo(g,h,i) perylene	0	1.2E-09	1.2E-09
Benzyl Chloride	0	1.5E-08	1.5E-08
Beryllium	0	1.2E-06	1.2E-06
Biphenyl	0	7.5E-08	7.5E-08
Bis(2-ethylhexyl) Phthalate (DEHP)	0	1.5E-09	1.5E-09
Bromoform	0	8.2E-10	8.2E-10
Cadmium	0	9.0E-06	9.0E-06
Carbon Disulfide	0	2.7E-09	2.7E-09
Carbon Tetrachloride	2.9E-07	8.9E-07	1.2E-06
CFC 13 (Methane, trichlorofluoro-)	4.6E-06	5.2E-07	5.1E-06
Chlorobenzene	0	4.6E-10	4.6E-10
Chloroform	0	1.2E-09	1.2E-09
Chlorine	1.0E-04	1.5E-05	1.2E-04
Chromium	1.4E-07	2.1E-05	2.1E-05
Chromium (VI)	0	3.5E-06	3.5E-06
Chrysene	0	4.4E-09	4.4E-09
Cobalt	0	1.5E-05	1.5E-05



Table 4-4  
 Atmospheric Emissions for the Production of LLDPE Resin  
 (lb per 1,000 lb or kg per 1,000 kg)  
 (page 2 of 2)

	Process emissions	Fuel-related emissions	Total emissions
Copper	0	2.7E-07	2.7E-07
Cumene	0	1.1E-10	1.1E-10
Cyanide	0	5.3E-08	5.3E-08
Dimethyl Sulfate	0	1.0E-09	1.0E-09
Dioxins (unspecified)	0	3.2E-08	3.2E-08
Ethyl Chloride	0	8.8E-10	8.8E-10
Ethylbenzene	0.011	0.0031	0.014
Ethylene Dibromide	9.1E-07	1.0E-07	1.0E-06
Ethylene Dichloride	0	8.4E-10	8.4E-10
Fluoranthene	0	3.1E-08	3.1E-08
Fluorene	0	4.0E-08	4.0E-08
Fluorides	0	3.6E-06	3.6E-06
Furans (unspecified)	0.0010	1.1E-10	0.0010
Hydrogen Chloride	1.0E-06	0.055	0.055
Hexane	0	1.4E-09	1.4E-09
Hydrogen Fluoride	0	0.0066	0.0066
Indeno(1,2,3-cd)pyrene	0	2.7E-09	2.7E-09
Isophorone (C9H14O)	0	1.2E-08	1.2E-08
Kerosene	0	5.7E-05	5.7E-05
Lead	0	2.5E-05	2.5E-05
Magnesium	0	4.9E-04	4.9E-04
Manganese	0	6.0E-05	6.0E-05
Mercaptan	0	4.2E-06	4.2E-06
Mercury	0	5.5E-06	5.5E-06
Metals (unspecified)	0	8.2E-04	8.2E-04
Methyl Bromide	0	3.4E-09	3.4E-09
Methyl Chloride	0	1.1E-08	1.1E-08
Methyl Ethyl Ketone	0	8.2E-09	8.2E-09
Methyl Hydrazine	0	3.6E-09	3.6E-09
Methyl Methacrylate	0	4.2E-10	4.2E-10
Methyl Tert Butyl Ether (MTBE)	0	7.4E-10	7.4E-10
Methylene Chloride	0	2.8E-05	2.8E-05
Naphthalene	0	8.2E-06	8.2E-06
Nickel	1.2E-06	1.7E-04	1.7E-04
Organics (unspecified)	0.011	2.7E-04	0.011
Perchloroethylene	0	2.0E-06	2.0E-06
Phenanthrene	0	1.2E-07	1.2E-07
Phenols	0	9.0E-06	9.0E-06
Polyaromatic Hydrocarbons (total)	1.2E-05	6.3E-06	1.8E-05
Propylene	0	6.0E-05	6.0E-05
Pyrene	0	1.5E-08	1.5E-08
Radionuclides (unspecified) (1)	0	0.0032	0.0032
Selenium	0	5.9E-05	5.9E-05
Styrene	0	5.3E-10	5.3E-10
Toluene	0.14	0.040	0.18
Trichloroethane	0	4.2E-10	4.2E-10
Vinyl Acetate	0	1.6E-10	1.6E-10
Xylenes	0.082	0.023	0.11
Zinc	0	1.8E-07	1.8E-07
Aluminum Compounds	1.0E-04	0	1.0E-04
HCFC-22	1.1E-05	0	1.1E-05
Hydrogen	0.0039	0	0.0039
NM VOC, non-methane volatile organic compounds, unspecified origin	0.14	0	0.14
Non-Methane Hydrocarbons	0.45	0	0.45

(1) The units for Radionuclides are Curies per 1,000 lbs of product. The total Radionuclides using metric units are 263,300 kBq per 1,000 kgs of product.

Source: Franklin Associates, A Division of ERG

Table 4-5

**Greenhouse Gas Summary for the Production of LLDPE Resin**  
**(lb carbon dioxide equivalents per 1,000 lb LLDPE or kg carbon dioxide equivalents per 1,000 kg LLDPE)**

	<u>Fuel-related CO2 Equiv.</u>	<u>Process CO2 Equiv.</u>	<u>Total CO2 Equiv.</u>
Carbon Dioxide - Fossil	1,347	118	1,465
Methane	271	155	425
Nitrous Oxide	5.91	5.07	11.0
Methyl Bromide	1.7E-08	0	1.7E-08
Methyl Chloride	1.8E-07	0	1.8E-07
Trichloroethane	5.9E-08	0	5.9E-08
Chloroform	3.7E-08	0	3.7E-08
Methylene Chloride	2.8E-04	0	2.8E-04
Carbon Tetrachloride	0.0013	4.0E-04	0.0017
CFC 13 (Methane, trichlorofluoro-	0.0059	0.052	0.058
HCFC-22	0	0.020	0.020
Total	<u>1,624</u>	<u>277</u>	<u>1,901</u>

Note: The 100 year global warming potentials used in this table are as follows: fossil carbon dioxide--1, methane--25, nitrous oxide--298, methyl bromide--5, methyl chloride--16, trichloroethane--140, chloroform--30, methylene chloride--10, carbon tetrachloride--1400, CFC-013--11,700, HCFC-22--1810, HCFC-123--77, and HFC-134a--1430.

Source: Franklin Associates, A Division of ERG

Table 4-6

**Waterborne Emissions for the Production of LLDPE Resin**  
 (lb per 1,000 lb or kg per 1,000 kg)  
 (page 1 of 2)

	Process emissions	Fuel-related emissions	Total emissions
<b>Waterborne Wastes</b>			
1-methylfluorene	2.0E-08	5.5E-09	2.6E-08
2,4 dimethylphenol	8.1E-06	2.1E-06	1.0E-05
2-Hexanone	1.9E-06	4.8E-07	2.4E-06
2-methyl naphthalene	4.5E-06	1.1E-06	5.6E-06
4-methyl-2-pentanone	7.4E-07	2.0E-07	9.5E-07
Acetone	1.8E-06	4.8E-07	2.3E-06
Acid (benzoic)	2.9E-04	7.4E-05	3.7E-04
Acid (hexanoic)	6.1E-05	1.5E-05	7.6E-05
Alkylated Benzenes	5.4E-05	1.4E-05	6.8E-05
Alkylated Fluorenes	3.1E-06	7.9E-07	3.9E-06
Alkylated Naphthalenes	8.9E-07	2.2E-07	1.1E-06
Alkylated Phenanthrenes	3.7E-07	9.3E-08	4.6E-07
Aluminum	0.028	0.0069	0.035
Ammonia	0.0062	0.0011	0.0073
Ammonium	0	2.6E-05	2.6E-05
Antimony	1.7E-05	4.2E-06	2.1E-05
Arsenic	5.5E-05	1.4E-05	6.9E-05
Barium	0.36	0.090	0.45
Benzene	3.2E-04	7.6E-05	3.9E-04
Beryllium	3.5E-06	8.7E-07	4.3E-06
BOD	0.038	0.045	0.083
Boron	9.1E-04	2.3E-04	0.0011
Bromide	0.035	0.0088	0.044
Cadmium	8.5E-06	2.5E-06	1.1E-05
Calcium	0.59	0.15	0.74
Chlorides (methyl chloride)	7.1E-09	1.9E-09	9.1E-09
Chlorides (unspecified)	0	1.83	1.83
Chromium (unspecified)	7.1E-04	1.8E-04	8.9E-04
Cobalt	6.4E-06	1.6E-06	8.1E-06
COD	0.12	0.017	0.13
Copper	7.7E-05	2.6E-05	1.0E-04
Cresols	1.7E-05	4.4E-06	2.2E-05
Cyanide	1.3E-08	3.5E-09	1.6E-08
Cymene	1.8E-08	4.8E-09	2.2E-08
Dibenzofuran	3.4E-08	9.1E-09	4.3E-08
Dibenzothiophene	2.7E-08	7.4E-09	3.5E-08
Dissolved Solids	7.36	1.82	9.18
Ethylbenzene	2.7E-05	4.2E-06	3.1E-05
Fluorine/Fluorides	1.5E-06	4.1E-04	4.2E-04
Hydrocarbons	0	1.5E-05	1.5E-05
Iron	0.049	0.014	0.064
Lead	1.5E-04	3.7E-05	1.8E-04
Lithium	0.14	0.040	0.18
Magnesium	0.12	0.029	0.15
Manganese	1.7E-04	6.2E-04	7.8E-04
Mercury	3.0E-07	8.4E-08	3.9E-07
Methyl Ethyl Ketone (MEK)	1.4E-08	3.9E-09	1.8E-08
Molybdenum	6.7E-06	1.7E-06	8.4E-06

Table 4-6

**Waterborne Emissions for the Production of LLDPE Resin**  
 (lb per 1,000 lb or kg per 1,000 kg)  
 (page 2 of 2)

	Process emissions	Fuel-related emissions	Total emissions
Naphthalene	5.3E-06	1.3E-06	6.6E-06
Nickel	6.7E-05	1.7E-05	8.3E-05
Nitrates	0	6.4E-05	6.4E-05
Nitrogen (ammonia)	0	2.2E-05	2.2E-05
Oil	0.011	0.0016	0.012
Pentamethyl benzene	1.3E-08	3.6E-09	1.7E-08
Phenanthrene	2.3E-07	5.9E-08	2.9E-07
Phenol/Phenolic Compounds	0.0011	2.7E-05	0.0012
Radionuclides (unspecified) (1)	0	4.5E-08	4.5E-08
Selenium	3.6E-06	9.8E-06	1.3E-05
Silver	3.6E-04	8.8E-05	4.4E-04
Sodium	1.68	0.42	2.09
Strontium	0.016	0.0040	0.020
Sulfates	0.012	0.044	0.057
Sulfides	4.0E-05	4.5E-06	4.4E-05
Sulfur	7.3E-04	1.9E-04	9.2E-04
Surfactants	1.4E-04	3.6E-05	1.8E-04
Suspended Solids	2.98	0.75	3.73
Thallium	3.5E-06	8.8E-07	4.4E-06
Tin	6.6E-05	1.7E-05	8.3E-05
Titanium	2.6E-04	6.4E-05	3.2E-04
Toluene	3.8E-04	7.0E-05	4.5E-04
Total Alkalinity	0.013	0.0032	0.016
Total Biphenyls	3.5E-06	8.8E-07	4.4E-06
Total Dibenzo-thiophenes	1.1E-08	2.7E-09	1.4E-08
Vanadium	1.9E-05	3.2E-06	2.2E-05
Xylenes	1.5E-04	3.6E-05	1.8E-04
Yttrium	2.0E-06	4.9E-07	2.4E-06
Zinc	6.1E-04	1.6E-04	7.8E-04
Butene	1.0E-04	0	1.0E-04
Cyclohexane	1.0E-04	0	1.0E-04
Lead 210	3.0E-14	0	3.0E-14
n-Decane	8.4E-06	0	8.4E-06
n-Docosane	1.9E-07	0	1.9E-07
n-Dodecane	1.6E-05	0	1.6E-05
n-Eicosane	4.4E-06	0	4.4E-06
n-Hexacosane	1.2E-07	0	1.2E-07
n-Hexadecane	1.7E-05	0	1.7E-05
n-Octadecane	4.3E-06	0	4.3E-06
Phosphorus	1.0E-04	0	1.0E-04
Radium 226	1.1E-11	0	1.1E-11
Radium 228	5.4E-14	0	5.4E-14
Styrene	1.0E-06	0	1.0E-06
Tetradecane	6.9E-06	0	6.9E-06
TOC	0.0010	0	0.0010

(1) The units for Radionuclides are Curies per 1,000 lbs of product. The total Radionuclides using metric units are 3.68 kBq per 1,000 kgs of product.

Source: Franklin Associates, A Division of ERG

## CHAPTER 5

## CRADLE-TO-RESIN LIFE CYCLE INVENTORY RESULTS FOR PP RESIN

This chapter presents LCI results for the production of polypropylene (PP) resin (cradle-to-resin). The results are given on the bases of 1,000 pounds and 1,000 kilograms of PP resin. Figure 5-1 presents the flow diagram for the production of PP resin. Process descriptions and individual process tables for each box shown in the flow diagram can be found in Appendix E of the Appendices (separate document).

Primary data was collected for olefins and PP resin production. A weighted average using production quantities was calculated from the olefins production data collected from three leading producers (8 thermal cracking units) in North America. As of 2003, there were 8 producers and at least 16 plants producing polymer-grade propylene in the U.S. The captured production amount is approximately 30 percent of the available capacity for olefin production. Numerous coproduct streams are produced from the olefins hydrocracker. Fuel gas and off-gas were two of the coproducts produced that were exported to another process for fuel. When these fuel coproducts are exported from the hydrocracker, they carry with them the allocated share of the inputs and outputs for their production. The separate appendices provide an in-depth discussion of this allocation. A mass basis was used to allocate the credit to the remaining material coproducts.

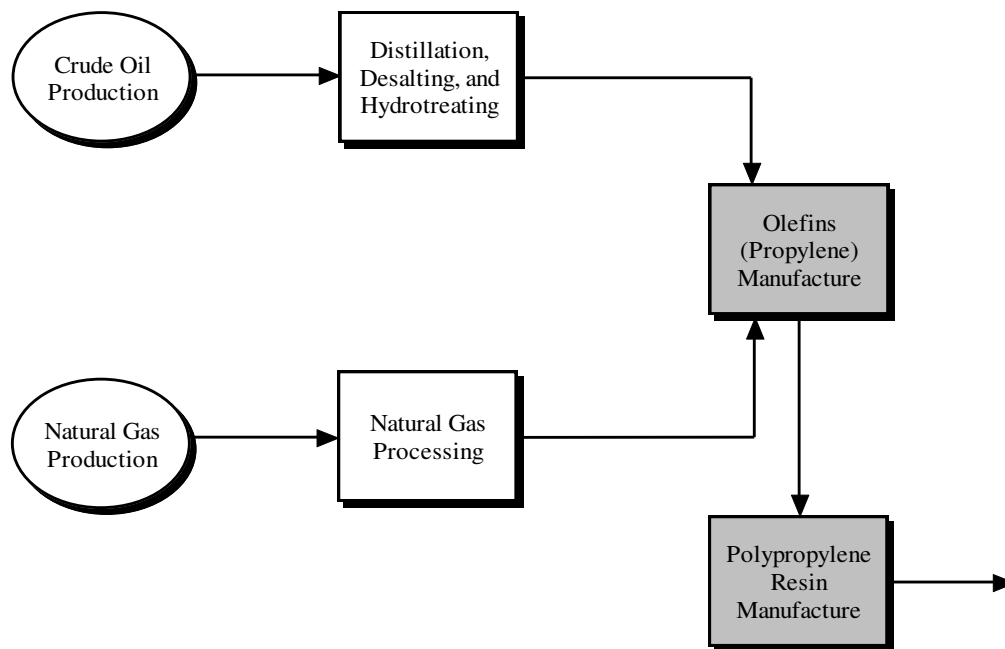

Figure 5-1. Flow diagram for the manufacture of virgin polypropylene (PP) resin. Shaded boxes represent partial or complete data provided by manufacturers specifically for this analysis.

A weighted average using production amounts was calculated from the PP production data from four plants collected from three leading producers in North America. As of 2003, there were 11 PP producers and 20 PP plants in the U.S. The captured production amount is more than 20 percent of the 2003 production amount for PP production in the U.S. and Canada. Scrap resin (e.g. off-spec) and some alkane/alkene streams are produced as a coproduct during this process. A mass basis was used to allocate the credit for each coproduct.

## DESCRIPTION OF TABLES

The average gross energy required to produce PP resin is 33.1 million Btu per 1,000 pounds of resin or 77.0 GJ per 1,000 kilograms of resin. Tables 5-1 and 5-2 show the breakdown of energy requirements for the production of PP resin by category and source, respectively. Precombustion energy (the energy used to extract and process fuels used for process energy and transportation energy) is included in the results shown in these tables. Table E-1 in the Appendices (separate document) provides the aggregated unit process energy (cradle-to-resin) for the production of PP resin. Natural gas and petroleum uses as raw material inputs for the production of PP, reported as energy of material resource in Table 5-1, are included in the totals for natural gas and petroleum energy in Table 5-2. Petroleum-based fuels (e.g. diesel fuel) are the dominant energy source for transportation. Non-fossil sources, such as hydropower, nuclear and other (geothermal, wind, etc.) shown in Table 5-2 are used to generate purchased electricity along with the fossil fuels.

**Table 5-1**

### Energy by Category for the Production of PP Resin

	<u>MMBtu per 1,000 pounds</u>	<u>GJ per 1,000 kilograms</u>
<b>Energy Category</b>		
Process (1)	11.8	27.5
Transportation	0.59	1.36
Energy of Material Resource	<u>20.7</u>	<u>48.1</u>
<b>Total Energy</b>	<b>33.1</b>	<b>77.0</b>
<b>Energy Category (Percent)</b>		
Process	36%	36%
Transportation	2%	2%
Energy of Material Resource	<u>62%</u>	<u>62%</u>
<b>Total</b>	<b>100%</b>	<b>100%</b>

(1) Process energy includes recovered energy, which is shown as a credit.

Source: Franklin Associates, A Division of ERG

Table 5-2

## Energy Profile for the Production of PP Resin

	<u>MM Btu per 1,000 pounds</u>	<u>GJ per 1,000 kilograms</u>
<b>Energy Source</b>		
Natural Gas	22.0	51.1
Petroleum	9.52	22.1
Coal	1.08	2.52
Hydropower	0.047	0.11
Nuclear	0.40	0.93
Wood	0	0
Other	0.073	0.17
<b>Recovered Energy (1)</b>	<u>-0.002</u>	<u>-0.005</u>
<b>Total Energy</b>	<b>33.1</b>	<b>77.0</b>
<b>Energy Source (Percent)</b>		
Natural Gas	66%	66%
Petroleum	29%	29%
Coal	3%	3%
Hydropower	0%	0%
Nuclear	1%	1%
Wood	0%	0%
Other	<u>0%</u>	<u>0%</u>
<b>Total</b>	<b>100%</b>	<b>100%</b>

(1) Recovered energy represents the recovery of energy as steam or condensate. Because this energy will be used by other processes, it is shown as a negative entry (credit).

Source: Franklin Associates, A Division of ERG

Table 5-3 shows the weight of solid waste generated during the production of PP resin. The process solid waste, those wastes produced directly from the cradle-to-resin processes, includes wastes that are incinerated both for disposal and for waste-to-energy, as well as landfilled. These categories have been provided separately. Solid waste from fuel production and combustion is also presented.

Both process and fuel-related, as well as total, atmospheric emissions are shown in Table 5-4. As defined in the report glossary, process emissions are those released directly from the sequence of processes that are used to extract, transform, fabricate, or otherwise affect changes on a material or product during its life cycle, while fuel-related emissions are those associated with the combustion of fuels used for process energy and transportation energy.

Table 5-3

## Solid Wastes by Weight for the Production of PP Resin

	<u>lb per 1,000 pounds</u>	<u>kg per 1,000 kilograms</u>
<b>Solid Wastes By Weight</b>		
Process		
Landfilled	34.1	34.1
Incinerated	7.63	7.63
Waste-to-Energy	0.0044	0.0044
Fuel	<u>43.3</u>	<u>43.3</u>
<b>Total</b>	<b>85.0</b>	<b>85.0</b>
<b>Weight Percent by Category</b>		
Process		
Landfilled	40%	40%
Incinerated	9%	9%
Waste-to-Energy	0%	0%
Fuel	<u>51%</u>	<u>51%</u>
<b>Total</b>	<b>100 %</b>	<b>100 %</b>

Source: Franklin Associates, A Division of ERG

Table 5-5 provides a greenhouse gas (GHG) summary for the production of PP resin. The primary three atmospheric emissions reported in this analysis that contribute to global warming are fossil fuel-derived carbon dioxide, methane, and nitrous oxide. (Non-fossil carbon dioxide emissions, such as those from the burning of wood, are considered part of the natural carbon cycle and are not considered a net contributor to global warming.) The 100-year global warming potential for each of these substances as reported in the Intergovernmental Panel on Climate Change (IPCC) 2007 report are shown in a note at the bottom of Table 5-5. The global warming potential represents the relative global warming contribution of a pound of a particular greenhouse gas compared to a pound of carbon dioxide. The weights of each of the contributing emissions in Table 5-4 are multiplied by their global warming potential and shown in Table 5-5.

Both process and fuel-related, as well as the total waterborne emissions are shown in Table 5-6. Definitions of process and fuel-related emissions are provided in this chapter, as well as in the glossary.



Table 5-4

**Atmospheric Emissions for the Production of PP Resin**  
**(lb per 1,000 lb or kg per 1,000 kg)**  
**(page 1 of 2)**

	Process emissions	Fuel-related emissions	Total emissions
<b>Atmospheric Emissions</b>			
Carbon Dioxide - Fossil	73.0	1,396	1,469
Methane	6.40	8.97	15.4
Nitrous Oxide	0.0045	0.019	0.024
Carbon Dioxide - Non-Fossil	0	4.72	4.72
Particulates (unspecified)	0.031	0.19	0.23
Particulates (PM10)	0.11	0.14	0.25
Particulates (PM2.5)	0.0098	0.091	0.10
Nitrogen Oxides	0.19	2.69	2.89
Sulfur Dioxide	1.54	2.05	3.60
Sulfur Oxides	0.0041	0.87	0.87
VOC (unspecified)	0.59	0.24	0.83
TNMOC (unspecified)	0	0.0061	0.0061
Hydrocarbons (unspecified)	0	0.026	0.026
Carbon Monoxide	0.30	0.80	1.10
1,3 Butadiene	0	8.3E-07	8.3E-07
2,4-Dinitrotoluene	0	7.5E-12	7.5E-12
2-Chloroacetophenone	0	1.9E-10	1.9E-10
5-Methyl Chrysene	0	1.2E-09	1.2E-09
Acenaphthene	0	2.8E-08	2.8E-08
Acenaphthylene	0	1.4E-08	1.4E-08
Acetophenone	0	4.0E-10	4.0E-10
acrolein	0	1.2E-04	1.2E-04
Aldehydes (Acetaldehyde)	0	4.7E-05	4.7E-05
Aldehydes (Formaldehyde)	0	8.0E-04	8.0E-04
Aldehydes (Propionaldehyde)	0	1.0E-08	1.0E-08
Aldehydes (unspecified)	0	5.4E-05	5.4E-05
Ammonia	0.0015	1.5E-04	0.0017
Ammonia Chloride	0	4.0E-05	4.0E-05
Anthracene	0	1.2E-08	1.2E-08
Antimony	8.7E-07	1.3E-06	2.1E-06
Arsenic	1.1E-07	2.8E-05	2.8E-05
Benzene	0.074	0.021	0.095
Benzo(a)anthracene	0	4.5E-09	4.5E-09
Benzo(a)pyrene	0	2.1E-09	2.1E-09
Benzo(b,j,k)fluoranthene	0	6.1E-09	6.1E-09
Benzo(g,h,i) perylene	0	1.5E-09	1.5E-09
Benzyl Chloride	0	1.9E-08	1.9E-08
Beryllium	0	1.5E-06	1.5E-06
Biphenyl	0	9.5E-08	9.5E-08
Bis(2-ethylhexyl) Phthalate (DEHP)	0	1.9E-09	1.9E-09
Bromoform	0	1.0E-09	1.0E-09
Cadmium	0	9.0E-06	9.0E-06
Carbon Disulfide	0	3.5E-09	3.5E-09
Carbon Tetrachloride	5.8E-07	1.1E-06	1.7E-06
CFC 13 (Methane, trichlorofluoro-)	9.3E-06	8.2E-07	1.0E-05
Chlorobenzene	0	5.9E-10	5.9E-10
Chloroform	0	1.6E-09	1.6E-09
Chlorine	1.0E-04	1.9E-05	1.2E-04
Chromium	2.9E-07	2.4E-05	2.4E-05

Table 5-4

**Atmospheric Emissions for the Production of PP Resin**  
(lb per 1,000 lb or kg per 1,000 kg)  
(page 2 of 2)

	Process emissions	Fuel-related emissions	Total emissions
Chromium (VI)	0	4.4E-06	4.4E-06
Chrysene	0	5.6E-09	5.6E-09
Cobalt	0	2.2E-05	2.2E-05
Copper	0	2.8E-07	2.8E-07
Cumene	0	1.4E-10	1.4E-10
Cyanide	0	6.7E-08	6.7E-08
Dimethyl Sulfate	0	1.3E-09	1.3E-09
Dioxins (unspecified)	0	4.1E-08	4.1E-08
Ethyl Chloride	0	1.1E-09	1.1E-09
Ethylbenzene	0.0087	0.0025	0.011
Ethylene Dibromide	1.8E-06	1.6E-07	2.0E-06
Ethylene Dichloride	0	1.1E-09	1.1E-09
Fluoranthene	0	4.0E-08	4.0E-08
Fluorene	0	5.1E-08	5.1E-08
Fluorides	0	4.5E-06	4.5E-06
Furans (unspecified)	0	1.4E-10	1.4E-10
Hydrogen Chloride	1.0E-06	0.070	0.070
Hexane	0	1.8E-09	1.8E-09
Hydrogen Fluoride	0	0.0084	0.0084
Indeno(1,2,3-cd)pyrene	0	3.4E-09	3.4E-09
Isophorone (C9H14O)	0	1.5E-08	1.5E-08
Kerosene	0	7.3E-05	7.3E-05
Lead	1.0E-12	3.2E-05	3.2E-05
Magnesium	0	6.1E-04	6.1E-04
Manganese	0	7.6E-05	7.6E-05
Mercaptan	0	5.3E-06	5.3E-06
Mercury	0	6.3E-06	6.3E-06
Metals (unspecified)	0	0.0010	0.0010
Methyl Bromide	0	4.3E-09	4.3E-09
Methyl Chloride	0	1.4E-08	1.4E-08
Methyl Ethyl Ketone	0	1.0E-08	1.0E-08
Methyl Hydrazine	0	4.5E-09	4.5E-09
Methyl Methacrylate	0	5.3E-10	5.3E-10
Methyl Tert Butyl Ether (MTBE)	0	9.3E-10	9.3E-10
Methylene Chloride	0	3.8E-05	3.8E-05
Naphthalene	0	9.2E-06	9.2E-06
Nickel	2.5E-06	2.5E-04	2.6E-04
Organics (unspecified)	0.011	3.4E-04	0.011
Perchloroethylene	0	2.6E-06	2.6E-06
Phenanthrene	0	1.5E-07	1.5E-07
Phenols	0	1.3E-05	1.3E-05
Polyaromatic Hydrocarbons (total)	2.4E-05	6.9E-06	3.1E-05
Propylene	0	5.5E-05	5.5E-05
Pyrene	0	1.8E-08	1.8E-08
Radionuclides (unspecified) (1)	0	0.0041	0.0041
Selenium	0	7.5E-05	7.5E-05
Styrene	0	6.7E-10	6.7E-10
Toluene	0.11	0.032	0.15
Trichloroethane	0	5.3E-10	5.3E-10
Vinyl Acetate	0	2.0E-10	2.0E-10
Xylenes	0.066	0.019	0.085
Zinc	1.0E-06	1.9E-07	1.2E-06
HCFC-22	1.0E-06	0	1.0E-06
Hydrogen	0.0052	0	0.0052
NM VOC, non-methane volatile organic compounds, unspecified origin	0.29	0	0.29
Non-Methane Hydrocarbons	0.26	0	0.26

(1) The units for Radionuclides are Curies per 1,000 lbs of product. The total Radionuclides using metric units are 333,200 kBq per 1,000 kgs of product.

Source: Franklin Associates, A Division of ERG

Table 5-5

**Greenhouse Gas Summary for the Production of PP Resin**  
**(lb carbon dioxide equivalents per 1,000 lb PP or kg carbon dioxide equivalents per 1,000 kg PP)**

	<u>Fuel-related CO2 Equiv.</u>	<u>Process CO2 Equiv.</u>	<u>Total CO2 Equiv.</u>
Carbon Dioxide - Fossil	1,396	73.0	1,469
Methane	224	160	384
Nitrous Oxide	5.70	1.34	7.04
Methyl Bromide	2.1E-08	0	2.1E-08
Methyl Chloride	2.3E-07	0	2.3E-07
Trichloroethane	7.5E-08	0	7.5E-08
Chloroform	4.7E-08	0	4.7E-08
Methylene Chloride	3.8E-04	0	3.8E-04
Carbon Tetrachloride	0.0016	8.1E-04	0.0024
CFC 13 (Methane, trichlorofluor	0.0096	0.11	0.12
HCFC-22	0	0.0018	0.0018
Total	<u>1,626</u>	<u>234</u>	<u>1,860</u>

Note: The 100 year global warming potentials used in this table are as follows: fossil carbon dioxide--1, methane--25, nitrous oxide--298, methyl bromide--5, methyl chloride--16, trichloroethane--140, chloroform--30, methylene chloride--10, carbon tetrachloride--1400, CFC-013--11,700, HCFC-22--1810, HCFC-123--77, and HFC-134a--1430.

Source: Franklin Associates, A Division of ERG

Table 5-6

**Waterborne Emissions for the Production of PP Resin**  
(lb per 1,000 lb or kg per 1,000 kg)  
(page 1 of 2)

	Process emissions	Fuel-related emissions	Total emissions
<b>Waterborne Wastes</b>			
1-methylfluorene	1.7E-08	4.5E-09	2.2E-08
2,4 dimethylphenol	8.1E-06	1.8E-06	9.9E-06
2-Hexanone	1.9E-06	4.2E-07	2.3E-06
2-methyl naphthalene	4.4E-06	9.9E-07	5.4E-06
4-methyl-2-pentanone	6.4E-07	1.7E-07	8.1E-07
Acetone	1.5E-06	4.0E-07	1.9E-06
Acid (benzoic)	2.9E-04	6.5E-05	3.6E-04
Acid (hexanoic)	6.1E-05	1.3E-05	7.4E-05
Alkylated Benzenes	5.5E-05	1.2E-05	6.7E-05
Alkylated Fluorenes	3.2E-06	6.9E-07	3.9E-06
Alkylated Naphthalenes	9.0E-07	2.0E-07	1.1E-06
Alkylated Phenanthrenes	3.7E-07	8.1E-08	4.5E-07
Aluminum	0.027	0.0062	0.033
Ammonia	0.0096	0.0012	0.011
Ammonium	0	3.2E-05	3.2E-05
Antimony	1.7E-05	3.7E-06	2.0E-05
Arsenic	5.6E-05	1.3E-05	6.9E-05
Barium	0.36	0.079	0.44
Benzene	3.2E-04	6.7E-05	3.9E-04
Beryllium	3.5E-06	7.6E-07	4.3E-06
BOD	0.046	0.055	0.10
Boron	9.1E-04	2.0E-04	0.0011
Bromide	0.036	0.0077	0.044
Cadmium	8.7E-06	2.4E-06	1.1E-05
Calcium	0.60	0.13	0.73
Chlorides (methyl chloride)	6.2E-09	1.6E-09	7.8E-09
Chlorides (unspecified)	0	1.60	1.60
Chromium (unspecified)	7.2E-04	1.6E-04	8.7E-04
Cobalt	6.4E-06	1.4E-06	7.8E-06
COD	0.17	0.019	0.19
Copper	7.8E-05	2.6E-05	1.0E-04
Cresols	1.7E-05	3.8E-06	2.1E-05
Cyanide	1.1E-08	2.9E-09	1.4E-08
Cymene	1.5E-08	4.0E-09	1.9E-08
Dibenzofuran	2.9E-08	7.6E-09	3.7E-08
Dibenzothiophene	2.4E-08	6.2E-09	3.0E-08
Dissolved Solids	7.57	1.60	9.17
Ethylbenzene	2.7E-05	3.7E-06	3.1E-05
Fluorine/Fluorides	1.5E-06	5.2E-04	5.3E-04
Hydrocarbons	0	1.3E-05	1.3E-05
Iron	0.050	0.013	0.063
Lead	1.5E-04	3.3E-05	1.8E-04
Lithium	0.11	0.033	0.15
Magnesium	0.12	0.026	0.15
Manganese	1.7E-04	7.6E-04	9.4E-04
Mercury	3.2E-07	7.8E-08	4.0E-07
Methyl Ethyl Ketone (MEK)	1.2E-08	3.2E-09	1.6E-08
Molybdenum	6.7E-06	1.5E-06	8.1E-06

Table 5-6

**Waterborne Emissions for the Production of PP Resin**  
**(lb per 1,000 lb or kg per 1,000 kg)**  
 (page 2 of 2)

	Process emissions	Fuel-related emissions	Total emissions
Naphthalene	5.3E-06	1.2E-06	6.4E-06
Nickel	6.7E-05	1.5E-05	8.2E-05
Nitrates	0	8.1E-05	8.1E-05
Nitrogen (ammonia)	0	2.8E-05	2.8E-05
Oil	0.0098	0.0016	0.011
Pentamethyl benzene	1.1E-08	3.0E-09	1.4E-08
Phenanthrene	2.3E-07	5.1E-08	2.8E-07
Phenol/Phenolic Compounds	0.0012	2.7E-05	0.0012
Radionuclides (unspecified) (1)	0	5.7E-08	5.7E-08
Selenium	3.9E-06	1.2E-05	1.6E-05
Silver	3.7E-04	7.8E-05	4.4E-04
Sodium	1.73	0.37	2.09
Strontium	0.016	0.0035	0.019
Sulfates	0.012	0.055	0.068
Sulfides	7.9E-05	7.0E-06	8.6E-05
Sulfur	7.2E-04	1.6E-04	8.8E-04
Surfactants	1.5E-04	3.2E-05	1.8E-04
Suspended Solids	2.99	0.66	3.65
Thallium	3.5E-06	7.7E-07	4.3E-06
Tin	6.7E-05	1.5E-05	8.1E-05
Titanium	2.6E-04	5.6E-05	3.1E-04
Toluene	3.9E-04	6.1E-05	4.5E-04
Total Alkalinity	0.013	0.0029	0.016
Total Biphenyls	3.5E-06	7.7E-07	4.3E-06
Total Dibenzo-thiophenes	1.1E-08	2.4E-09	1.3E-08
Vanadium	3.1E-05	3.7E-06	3.4E-05
Xylenes	1.5E-04	3.2E-05	1.8E-04
Yttrium	1.9E-06	4.3E-07	2.4E-06
Zinc	6.2E-04	1.5E-04	7.7E-04
Lead 210	3.0E-14	0	3.0E-14
n-Decane	8.4E-06	0	8.4E-06
n-Docosane	1.6E-07	0	1.6E-07
n-Dodecane	1.6E-05	0	1.6E-05
n-Eicosane	4.4E-06	0	4.4E-06
n-Hexacosane	1.0E-07	0	1.0E-07
n-Hexadecane	1.7E-05	0	1.7E-05
n-Octadecane	4.3E-06	0	4.3E-06
Radium 226	1.0E-11	0	1.0E-11
Radium 228	5.4E-14	0	5.4E-14
Styrene	1.0E-06	0	1.0E-06
Tetradecane	6.8E-06	0	6.8E-06
TOC	0.0010	0	0.0010

(1) The units for Radionuclides are Curies per 1,000 lbs of product. The total Radionuclides using metric units are 4.66 kBq per 1,000 kgs of product.

Source: Franklin Associates, A Division of ERG

## CHAPTER 6

## CRADLE-TO-RESIN LIFE CYCLE INVENTORY RESULTS FOR PET RESIN

This chapter presents LCI results for the production of polyethylene terephthalate (PET) resin (cradle-to-resin). The results are given on the bases of 1,000 pounds and 1,000 kilograms of PET resin. Figure 6-1 presents the flow diagram for the production of PET resin. Process descriptions and individual process tables for each box shown in the flow diagram can be found in Appendix F of the Appendices (separate document).

Primary data was collected for olefins, acetic acid, TPA/PTA and PET resin production. A weighted average using production quantities was calculated from the olefins production data collected from three leading producers (8 thermal cracking units) in North America. As of 2003, there were 16 olefin producers and at least 29 olefin plants in the U.S. The captured production amount is approximately 30 percent of the available capacity for olefin production. Numerous coproduct streams are produced from the olefins hydrocracker. Fuel gas and off-gas were two of the coproducts produced that were exported to another process for fuel. When these fuel coproducts are exported from the hydrocracker, they carry with them the allocated share of the inputs and outputs for their production. The separate appendices provide an in-depth discussion of this allocation. A mass basis was used to allocate the credit to the remaining material coproducts.

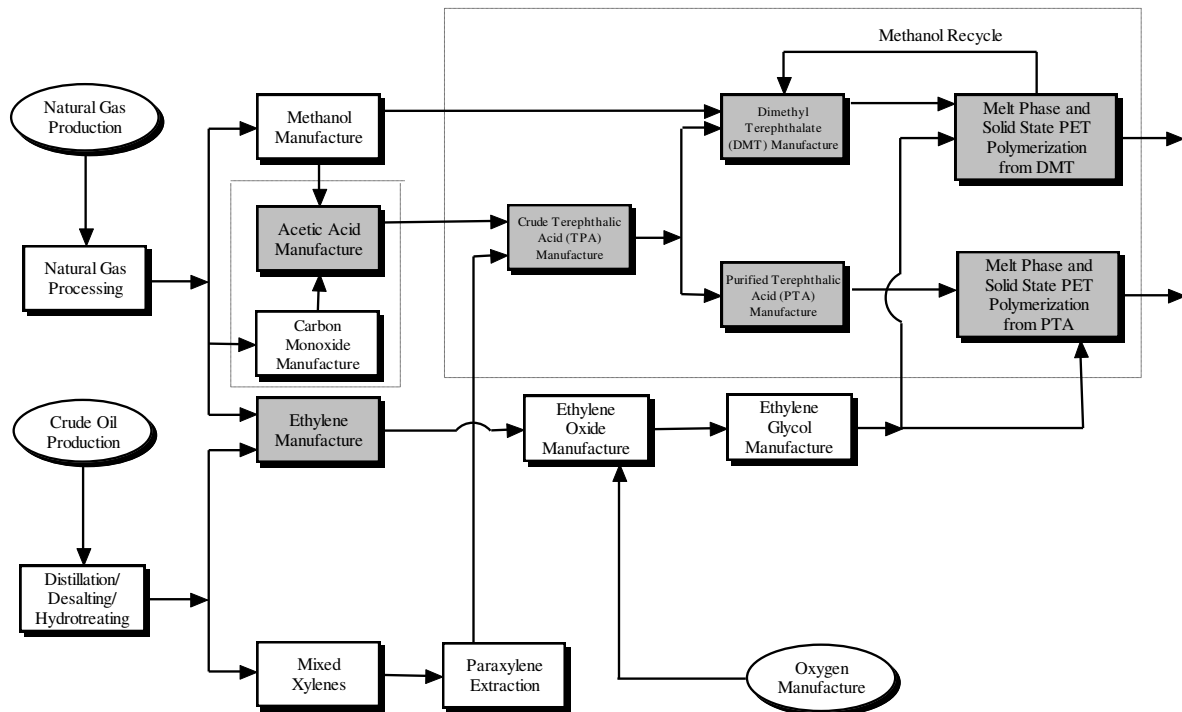

Figure 6-1. Flow diagram for the manufacture of virgin polyethylene terephthalate (PET) resin. Shaded boxes represent partial or complete data provided by manufacturers specifically for this analysis. Boxes within the dotted rectangle are included in an aggregated dataset.

Only one company provided 2003 data for acetic acid. This dataset was arithmetically averaged with a confidential dataset from 1994. Mixed acid and off-gas are coproducts of acetic acid. A mass basis was used to allocate the credit for the acid, while the energy amount for the off-gas was reported separately as recovered energy.

The data in this table includes an aggregation of TPA, PTA, DMT, and PET production. New data was collected for DMT, PTA (including TPA), and PET production. A weighted average using production amounts was calculated from the PTA production data from two plants collected from two leading producers in North America. A weighted average using production amounts was also calculated from the PET production data from two plants collected from two leading producers in North America. Data from primary sources in the early 1990's was used for PET from DMT production. The two PET technologies were weighted accordingly at 15 percent PET from DMT and 85 percent PET from PTA.

As of 2003, there were 16 PET producers and 29 PET plants in the U.S. The captured production amount is approximately 15 percent of the 2003 production amount for PET production from PTA in the U.S. and Canada. Scrap resin (e.g. off-spec) and steam are produced as coproducts during the production of PET from PTA. A mass basis was used to allocate the credit for scrap, while the energy amount for the steam was reported separately as recovered energy.

## DESCRIPTION OF TABLES

The average gross energy required to produce PET resin is 30.3 million Btu per 1,000 pounds of resin or 70.4 GJ per 1,000 kilograms of resin. Tables 6-1 and 6-2 show the breakdown of energy requirements for the production of PET resin by category and source, respectively. Precombustion energy (the energy used to extract and process fuels used for process energy and transportation energy) is included in the results shown in these tables. Table F-1 in the Appendices (separate document) provides the aggregated unit process energy (cradle-to-resin) for the production of PET resin. Natural gas and petroleum used as raw material inputs for the production of PET, reported as energy of material resource in Table 6-1, are included in the totals for natural gas and petroleum energy in Table 6-2. Petroleum-based fuels (e.g. diesel fuel) are the dominant energy source for transportation. Non-fossil sources, such as hydropower, nuclear and other (geothermal, wind, etc.) shown in Table 6-2 are used to generate purchased electricity along with the fossil fuels.

Table 6-1

## Energy by Category for the Production of PET Resin

	<u>MMBtu per 1,000 pounds</u>	<u>GJ per 1,000 kilograms</u>
<b>Energy Category</b>		
Process (1)	14.3	33.3
Transportation	0.68	1.57
Energy of Material Resource	<u>15.3</u>	<u>35.5</u>
<b>Total Energy</b>	<b>30.3</b>	<b>70.4</b>
<b>Energy Category (Percent)</b>		
Process	47%	47%
Transportation	2%	2%
Energy of Material Resource	<u>50%</u>	<u>50%</u>
<b>Total</b>	<b>100%</b>	<b>100%</b>

---

(1) Process energy includes recovered energy, which is shown as a credit.

Source: Franklin Associates, A Division of ERG



Table 6-2

## Energy Profile for the Production of PET Resin

	<u>MM Btu per 1,000 pounds</u>	<u>GJ per 1,000 kilograms</u>
<b>Energy Source</b>		
Natural Gas	12.8	29.7
Petroleum	13.5	31.5
Coal	2.84	6.61
Hydropower	0.11	0.25
Nuclear	0.90	2.10
Wood	0	0
Other	0.17	0.38
<b>Recovered Energy (1)</b>	<u>-0.064</u>	<u>-0.15</u>
<b>Total Energy</b>	<b>30.3</b>	<b>70.4</b>
<b>Energy Source (Percent)</b>		
Natural Gas	42%	42%
Petroleum	45%	45%
Coal	9%	9%
Hydropower	0%	0%
Nuclear	3%	3%
Wood	0%	0%
Other	<u>1%</u>	<u>1%</u>
<b>Total</b>	<b>100%</b>	<b>100%</b>

(1) Recovered energy represents the recovery of energy as steam or condensate. Because this energy will be used by other processes, it is shown as a negative entry (credit).

Source: Franklin Associates, A Division of ERG

Table 6-3 shows the weight of solid waste generated during the production of PET resin. The process solid waste, those wastes produced directly from the cradle-to-resin processes, includes wastes that are incinerated both for disposal and for waste-to-energy, as well as landfilled. These categories have been provided separately. Solid waste from fuel production and combustion is also presented.

Both process and fuel-related, as well as total, atmospheric emissions are shown in Table 6-4. As defined in the report glossary, process emissions are those released directly from the sequence of processes that are used to extract, transform, fabricate, or otherwise affect changes on a material or product during its life cycle, while fuel-related emissions are those associated with the combustion of fuels used for process energy and transportation energy.

Table 6-3

## Solid Wastes by Weight for the Production of PET Resin

	<u>lb per 1,000 pounds</u>	<u>kg per 1,000 kilograms</u>
<b>Solid Wastes By Weight</b>		
Process		
Landfilled	32.9	32.9
Incinerated	1.03	1.03
Waste-to-Energy	0.59	0.59
Fuel	<u>106</u>	<u>106</u>
<b>Total</b>	<b>141</b>	<b>141</b>
 <b>Weight Percent by Category</b>		
Process		
Landfilled	23%	23%
Incinerated	1%	1%
Waste-to-Energy	0%	0%
Fuel	<u>75%</u>	<u>75%</u>
<b>Total</b>	<b>100 %</b>	<b>100 %</b>

---

Source: Franklin Associates, A Division of ERG

Table 6-4

**Atmospheric Emissions for the Production of PET Resin**  
**(lb per 1,000 lb or kg per 1,000 kg)**  
**(page 1 of 2)**

	Process emissions	Fuel-related emissions	Total emissions
<b>Atmospheric Emissions</b>			
Carbon Dioxide - Fossil	294	2,098	2,391
Methane	5.25	7.83	13.1
Nitrous Oxide	0	0.049	0.049
Carbon Dioxide - Non-Fossil	0	10.7	10.7
Particulates (unspecified)	0.15	0.48	0.63
Particulates (PM10)	0.038	0.45	0.49
Particulates (PM2.5)	0.013	0.25	0.26
Nitrogen Oxides	0.29	5.42	5.71
Sulfur Dioxide	0.59	4.94	5.53
Sulfur Oxides	0.0015	1.79	1.79
VOC (unspecified)	0.18	0.40	0.59
TNMOC (unspecified)	0.069	0.019	0.088
Hydrocarbons (unspecified)	0	0.094	0.094
Carbon Monoxide	6.06	1.28	7.33
1,3 Butadiene	0	7.8E-07	7.8E-07
2,4-Dinitrotoluene	0	5.1E-09	5.1E-09
2-Chloroacetophenone	0	1.3E-07	1.3E-07
5-Methyl Chrysene	0	3.2E-09	3.2E-09
Acenaphthene	0	7.3E-08	7.3E-08
Acenaphthylene	0	3.6E-08	3.6E-08
Acetophenone	0	2.7E-07	2.7E-07
acrolein	0	2.6E-04	2.6E-04
Aldehydes (Acetaldehyde)	0	7.8E-05	7.8E-05
Aldehydes (Formaldehyde)	0	0.0015	0.0015
Aldehydes (Propionaldehyde)	0	6.9E-06	6.9E-06
Aldehydes (unspecified)	0.17	1.2E-04	0.17
Ammonia	0.0020	5.1E-04	0.0025
Ammonia Chloride	0	9.1E-05	9.1E-05
Anthracene	0	3.0E-08	3.0E-08
Antimony	1.1E-06	3.3E-06	4.4E-06
Arsenic	1.4E-07	7.6E-05	7.6E-05
Benzene	0.023	0.034	0.058
Benzo(a)anthracene	0	1.2E-08	1.2E-08
Benzo(a)pyrene	0	5.5E-09	5.5E-09
Benzo(b,j,k)fluoranthene	0	1.6E-08	1.6E-08
Benzo(g,h,i) perylene	0	3.9E-09	3.9E-09
Benzyl Chloride	0	1.3E-05	1.3E-05
Beryllium	0	4.2E-06	4.2E-06
Biphenyl	0	2.4E-07	2.4E-07
Bis(2-ethylhexyl) Phthalate (DEHP)	0	1.3E-06	1.3E-06
Bromoform	0	7.0E-07	7.0E-07
Cadmium	0	2.1E-05	2.1E-05
Carbon Disulfide	0	2.3E-06	2.3E-06
Carbon Tetrachloride	7.7E-07	2.7E-06	3.4E-06
CFC 13 (Methane, trichlorofluoro-)	1.2E-05	3.0E-06	1.5E-05
Chlorobenzene	0	4.0E-07	4.0E-07
Chloroform	0	1.1E-06	1.1E-06
Chlorine	2.0E-05	4.3E-05	6.3E-05
Chromium	3.8E-07	5.8E-05	5.8E-05
Chromium (VI)	0	1.1E-05	1.1E-05
Chrysene	0	1.4E-08	1.4E-08
Cobalt	0	8.3E-05	8.3E-05

Table 6-4

**Atmospheric Emissions for the Production of PET Resin**  
(lb per 1,000 lb or kg per 1,000 kg)  
(page 2 of 2)

	Process emissions	Fuel-related emissions	Total emissions
Copper	0	1.7E-06	1.7E-06
Cumene	0	9.6E-08	9.6E-08
Cyanide	0	4.5E-05	4.5E-05
Dimethyl Sulfate	0	8.7E-07	8.7E-07
Dioxins (unspecified)	0	9.2E-08	9.2E-08
Ethyl Chloride	0	7.6E-07	7.6E-07
Ethylbenzene	0.0027	0.0038	0.0066
Ethylene Dibromide	2.4E-06	6.0E-07	3.0E-06
Ethylene Dichloride	0	7.2E-07	7.2E-07
Fluoranthene	0	1.0E-07	1.0E-07
Fluorene	0	1.3E-07	1.3E-07
Fluorides	0	8.1E-04	8.1E-04
Furans (unspecified)	0	3.2E-10	3.2E-10
Hydrogen Chloride	2.0E-07	0.17	0.17
Hexane	0	1.2E-06	1.2E-06
Hydrogen Fluoride	0	0.021	0.021
Indeno(1,2,3-cd)pyrene	0	8.8E-09	8.8E-09
Isophorone (C <sub>9</sub> H <sub>14</sub> O)	0	1.0E-05	1.0E-05
Kerosene	0	1.6E-04	1.6E-04
Lead	0	1.4E-04	1.4E-04
Magnesium	0	0.0016	0.0016
Manganese	0	1.9E-04	1.9E-04
Mercaptan	0	0.0039	0.0039
Mercury	0	3.8E-05	3.8E-05
Metals (unspecified)	0	0.0024	0.0024
Methyl Bromide	0	2.9E-06	2.9E-06
Methyl Chloride	0	9.6E-06	9.6E-06
Methyl Ethyl Ketone	0	7.0E-06	7.0E-06
Methyl Hydrazine	0	3.1E-06	3.1E-06
Methyl Methacrylate	0	3.6E-07	3.6E-07
Methyl Tert Butyl Ether (MTBE)	0	6.3E-07	6.3E-07
Methylene Chloride	0	1.2E-04	1.2E-04
Naphthalene	0	2.4E-05	2.4E-05
Nickel	3.2E-06	0.0010	0.0010
Organics (unspecified)	1.11	7.7E-04	1.11
Perchloroethylene	0	7.1E-06	7.1E-06
Phenanthrene	0	3.9E-07	3.9E-07
Phenols	0	5.3E-05	5.3E-05
Polyaromatic Hydrocarbons (total)	3.1E-05	1.4E-05	4.5E-05
Propylene	0	5.2E-05	5.2E-05
Pyrene	0	4.7E-08	4.7E-08
Radionuclides (unspecified) (1)	0	0.0092	0.0092
Selenium	0	2.0E-04	2.0E-04
Styrene	0	4.5E-07	4.5E-07
Toluene	0.035	0.050	0.085
Trichloroethane	0	3.6E-07	3.6E-07
Vinyl Acetate	0	1.4E-07	1.4E-07
Xylenes	0.062	0.029	0.091
Zinc	0	1.1E-06	1.1E-06
Acetic Acid	0.051	0	0.051
Bromine	0.079	0	0.079
Ethylene Oxide	0.024	0	0.024
HCFC-22	2.0E-07	0	2.0E-07
Hydrogen	7.9E-04	0	7.9E-04
Methanol	0.0015	0	0.0015
Methyl Acetate	0.040	0	0.040
NM VOC, non-methane volatile organic compounds, unspecified origin	0.38	0	0.38
Non-Methane Hydrocarbons	5.57	0	5.57

(1) The units for Radionuclides are Curies per 1,000 lbs of product. The total Radionuclides using metric units are 751,300 kBq per 1,000 kgs of product.

Source: Franklin Associates, A Division of ERG

Table 6-5 provides a greenhouse gas (GHG) summary for the production of PET resin. The primary three atmospheric emissions reported in this analysis that contribute to global warming are fossil fuel-derived carbon dioxide, methane, and nitrous oxide. (Non-fossil carbon dioxide emissions, such as those from the burning of wood, are considered part of the natural carbon cycle and are not considered a net contributor to global warming.) The 100-year global warming potential for each of these substances as reported in the Intergovernmental Panel on Climate Change (IPCC) 2007 report are shown in a note at the bottom of Table 6-5. The global warming potential represents the relative global warming contribution of a pound of a particular greenhouse gas compared to a pound of carbon dioxide. The weights of each of the contributing emissions in Table 6-4 are multiplied by their global warming potential and shown in Table 6-5.

Both process and fuel-related, as well as the total waterborne emissions are shown in Table 6-6. Definitions of process and fuel-related emissions are provided in this chapter, as well as in the glossary.

Table 6-5

**Greenhouse Gas Summary for the Production of PET Resin**  
(lb carbon dioxide equivalents per 1,000 lb PET or kg carbon dioxide equivalents per 1,000 kg PET)

	<u>Fuel-related CO2 Equiv.</u>	<u>Process CO2 Equiv.</u>	<u>Total CO2 Equiv.</u>
Carbon Dioxide - Fossil	2,098	294	2,391
Methane	196	131	327
Nitrous Oxide	14.6	0	14.6
Methyl Bromide	1.4E-05	0	1.4E-05
Methyl Chloride	1.5E-04	0	1.5E-04
Trichloroethane	5.1E-05	0	5.1E-05
Chloroform	3.2E-05	0	3.2E-05
Methylene Chloride	0.0012	0	0.0012
Carbon Tetrachloride	0.0037	0.0011	0.0048
CFC 13 (Methane, trichlorofluor	0.035	0.14	0.18
HCFC-22	0	3.6E-04	3.6E-04
Total	<u>2,308</u>	<u>425</u>	<u>2,733</u>

Note: The 100 year global warming potentials used in this table are as follows: fossil carbon dioxide--1, methane--25, nitrous oxide--298, methyl bromide--5, methyl chloride--16, trichloroethane--140, chloroform--30, methylene chloride--10, carbon tetrachloride--1400, CFC-013--11,700, HCFC-22--1810, HCFC-123--77, and HFC-134a--1430.

Source: Franklin Associates, A Division of ERG

Table 6-6

**Waterborne Emissions for the Production of PET Resin**  
 (lb per 1,000 lb or kg per 1,000 kg)  
 (page 1 of 2)

	Process emissions	Fuel-related emissions	Total emissions
<b>Waterborne Wastes</b>			
1-methylfluorene	7.7E-09	7.4E-09	1.5E-08
2,4 dimethylphenol	5.3E-06	3.2E-06	8.5E-06
2-Hexanone	1.2E-06	7.6E-07	2.0E-06
2-methyl naphthalene	2.8E-06	1.8E-06	4.6E-06
4-methyl-2-pentanone	2.9E-07	2.7E-07	5.6E-07
Acetone	6.8E-07	6.5E-07	1.3E-06
Acid (benzoic)	1.9E-04	1.2E-04	3.1E-04
Acid (hexanoic)	3.9E-05	2.4E-05	6.4E-05
Acid (unspecified)	0.036	0	0.036
Alkylated Benzenes	3.6E-05	2.2E-05	5.8E-05
Alkylated Fluorenes	2.1E-06	1.3E-06	3.3E-06
Alkylated Naphthalenes	5.9E-07	3.6E-07	9.4E-07
Alkylated Phenanthrenes	2.4E-07	1.5E-07	3.9E-07
Aluminum	0.018	0.011	0.029
Ammonia	0.12	0.0033	0.12
Ammonium	0.0013	7.3E-05	0.0014
Antimony	1.2E-05	6.7E-06	1.9E-05
Arsenic	3.8E-05	2.4E-05	6.2E-05
Barium	0.24	0.14	0.38
Benzene	2.1E-04	1.2E-04	3.4E-04
Beryllium	2.4E-06	1.4E-06	3.8E-06
BOD	0.91	0.12	1.03
Boron	5.9E-04	3.6E-04	9.5E-04
Bromide	0.025	0.014	0.039
Cadmium	5.8E-06	4.5E-06	1.0E-05
Calcium	0.41	0.24	0.65
Chlorides (methyl chloride)	2.7E-09	2.6E-09	5.3E-09
Chlorides (unspecified)	0	2.95	2.95
Chromium (unspecified)	0.0068	2.8E-04	0.0071
Cobalt	4.2E-06	2.6E-06	6.7E-06
COD	1.64	0.051	1.69
Copper	5.1E-05	5.4E-05	1.0E-04
Cresols	1.1E-05	6.9E-06	1.8E-05
Cyanide	4.9E-09	4.7E-09	9.6E-09
Cymene	6.8E-09	6.5E-09	1.3E-08
Dibenzofuran	1.3E-08	1.2E-08	2.5E-08
Dibenzothiophene	1.0E-08	1.0E-08	2.0E-08
Dissolved Solids	5.23	2.98	8.21
Ethylbenzene	1.4E-05	6.9E-06	2.1E-05
Fluorine/Fluorides	5.2E-05	0.0012	0.0012
Hydrocarbons	0	2.3E-05	2.3E-05
Iron	0.033	0.025	0.058
Lead	9.8E-05	6.1E-05	1.6E-04
Lithium	0.036	0.050	0.086
Magnesium	0.081	0.048	0.13
Manganese	1.2E-04	0.0019	0.0020
Mercury	2.3E-07	1.5E-07	3.8E-07
Metal (unspecified)	4.5E-06	0	4.5E-06
Methyl Ethyl Ketone (MEK)	5.5E-09	5.2E-09	1.1E-08
Molybdenum	4.3E-06	2.7E-06	7.0E-06

Table 6-6

**Waterborne Emissions for the Production of PET Resin**  
 (lb per 1,000 lb or kg per 1,000 kg)  
 (page 2 of 2)

	Process emissions	Fuel-related emissions	Total emissions
Naphthalene	3.4E-06	2.1E-06	5.5E-06
Nickel	4.5E-05	2.7E-05	7.2E-05
Nitrates	0	1.8E-04	1.8E-04
Nitrogen (ammonia)	0	6.4E-05	6.4E-05
Oil	0.0095	0.0036	0.013
Pentamethyl benzene	5.1E-09	4.9E-09	1.0E-08
Phenanthrene	1.5E-07	9.3E-08	2.4E-07
Phenol/Phenolic Compounds	3.9E-04	6.5E-05	4.6E-04
Radionuclides (unspecified) (1)	0	1.3E-07	1.3E-07
Selenium	3.0E-06	2.7E-05	3.0E-05
Silver	2.5E-04	1.4E-04	3.9E-04
Sodium	1.19	0.68	1.87
Strontium	0.010	0.0063	0.017
Sulfates	0.0085	0.12	0.13
Sulfides	1.0E-04	2.5E-05	1.3E-04
Sulfur	4.6E-04	2.9E-04	7.5E-04
Surfactants	9.9E-05	5.8E-05	1.6E-04
Suspended Solids	2.02	1.21	3.23
Thallium	2.3E-06	1.4E-06	3.7E-06
Tin	4.3E-05	2.6E-05	7.0E-05
Titanium	1.7E-04	1.0E-04	2.7E-04
Toluene	2.2E-04	1.1E-04	3.3E-04
Total Alkalinity	0.0092	0.0053	0.014
Total Biphenyls	2.3E-06	1.4E-06	3.7E-06
Total Dibenzo-thiophenes	7.2E-09	4.3E-09	1.2E-08
Vanadium	3.5E-05	1.0E-05	4.5E-05
Xylenes	1.0E-04	5.9E-05	1.6E-04
Yttrium	1.3E-06	7.8E-07	2.0E-06
Zinc	0.0084	2.8E-04	0.0087
Acetaldehyde	0.025	0	0.025
Lead 210	2.0E-14	0	2.0E-14
n-Decane	5.4E-06	0	5.4E-06
n-Docosane	7.3E-08	0	7.3E-08
n-Dodecane	1.0E-05	0	1.0E-05
n-Eicosane	2.8E-06	0	2.8E-06
n-Hexacosane	4.5E-08	0	4.5E-08
n-Hexadecane	1.1E-05	0	1.1E-05
n-Octadecane	2.8E-06	0	2.8E-06
Phosphates	5.1E-04	0	5.1E-04
Radium 226	6.8E-12	0	6.8E-12
Radium 228	3.5E-14	0	3.5E-14
Styrene	2.0E-07	0	2.0E-07
Tetradecane	4.3E-06	0	4.3E-06
TOC	0.044	0	0.044

(1) The units for Radionuclides are Curies per 1,000 lbs of product. The total Radionuclides using metric units are 10.51 kBq per 1,000 kgs of product.

Source: Franklin Associates, A Division of ERG

## CHAPTER 7

## CRADLE-TO-RESIN LIFE CYCLE INVENTORY RESULTS FOR GPPS RESIN

This chapter presents LCI results for the production of general purpose polystyrene (GPPS) resin (cradle-to-resin). The results are given on the bases of 1,000 pounds and 1,000 kilograms of GPPS resin. Figure 7-1 presents the flow diagram for the production of GPPS resin. Process descriptions and individual process tables for each box shown in the flow diagram can be found in Appendix G of the Appendices (separate document).

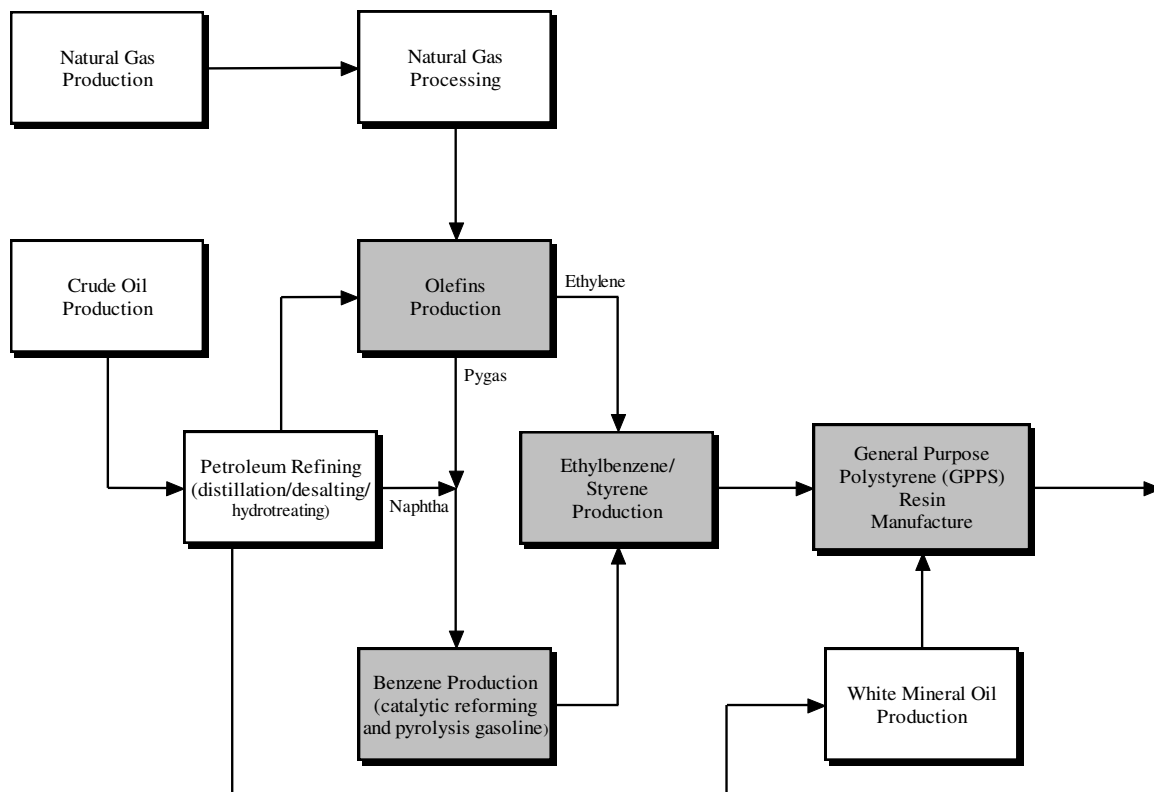

Figure 7-1. Flow diagram for the production of general purpose polystyrene resin. Shaded boxes represent partial or complete data provided by manufacturers specifically for this analysis.



Primary data was collected for olefins, benzene, ethylbenzene/styrene, and GPPS resin production. A weighted average using production quantities was calculated from the olefins production data collected from three leading producers (8 thermal cracking units) in North America. As of 2003, there were 16 olefin producers and at least 29 olefin plants in the U.S. The captured production amount is approximately 30 percent of the available capacity for olefin production. Numerous coproduct streams are produced from the olefins hydrocracker. Fuel gas and off-gas were two of the coproducts produced that were exported to another process for fuel. When these fuel coproducts are exported from the hydrocracker, they carry with them the allocated share of the inputs and outputs for their production. The separate appendices provide an in-depth discussion of this allocation. A mass basis was used to allocate the credit to the remaining material coproducts.

It is estimated that one-third of the benzene production is from pyrolysis gasoline and two-thirds are produced from catalytic reforming. These percentages were used to weight the collected datasets for benzene. Catalytic reforming is represented by 2 primary datasets from 1992. The benzene data collected for this analysis represent 1 producer and 1 plant in the U.S. using the pyrolysis gasoline production method. As of 2002 there were 22 benzene producers and 38 benzene plants in the U.S. for the three standard technologies. The captured production amount is approximately 10 percent of the available capacity for benzene production in the U.S. Numerous aromatic coproduct streams are produced during this process. Fuel gas and off-gas were two of the coproducts produced that were exported to another process for fuel. When these fuel coproducts are exported from the reactor, they carry with them the allocated share of the inputs and outputs for their production. The separate appendices provide an in-depth discussion of this allocation. A mass basis was used to allocate the credit the remaining aromatic products.

Two of the three ethylbenzene/styrene datasets were collected for this project and represents 2002-2003 data, while the other dataset comes from 1993. As of 2001 there were 8 styrene producers and 8 styrene plants in the U.S. The styrene data collected for this module represent 2 producers and 2 plants in the U.S. The captured production amount is approximately 25 percent of the available capacity for styrene production in the U.S. Various coproduct streams are produced during this process. A mass basis was used to allocate the credit these coproducts in the datasets collected during this analysis.

A weighted average using production amounts was calculated from the GPPS production data from six plants collected from four leading producers in North America. As of 2002 there were 12 PS producers and 24 PS plants in the U.S. The captured production amount is approximately 20 percent of the available capacity for all polystyrene production in the U.S. and Canada. Scrap resin (e.g. off-spec) and some alkane/alkene streams are produced as a coproduct during this process. A mass basis was used to allocate the credit for each coproduct.

## DESCRIPTION OF TABLES

The average gross energy required to produce GPPS resin is 40.9 million Btu per 1,000 pounds of resin or 95.1 GJ per 1,000 kilograms of resin. Tables 7-1 and 7-2 show the breakdown of energy requirements for the production of GPPS resin by category and source, respectively. Precombustion energy (the energy used to extract and process fuels used for process energy and transportation energy) is included in the results shown in these tables. Table G-1 in the Appendices (separate document) provides the aggregated unit process energy (cradle-to-resin) for the production of GPPS resin. Natural gas and petroleum used as raw material inputs for the production of GPPS, reported as energy of material resource in Table 7-1, are included in the totals for natural gas and petroleum energy in Table 7-2. Petroleum-based fuels (e.g. diesel fuel) are the dominant energy source for transportation. Non-fossil sources, such as hydropower, nuclear and other (geothermal, wind, etc.) shown in Table 7-2 are used to generate purchased electricity along with the fossil fuels.

**Table 7-1**

### Energy by Category for the Production of GPPS Resin

	<u>MMBtu per 1,000 pounds</u>	<u>GJ per 1,000 kilograms</u>
<b>Energy Category</b>		
Process (1)	18.1	42.1
Transportation	1.12	2.59
Energy of Material Resource	<u>21.7</u>	<u>50.4</u>
<b>Total Energy</b>	<b>40.9</b>	<b>95.1</b>
<b>Energy Category (Percent)</b>		
Process	44%	44%
Transportation	3%	3%
Energy of Material Resource	<u>53%</u>	<u>53%</u>
<b>Total</b>	<b>100%</b>	<b>100%</b>

(1) Process energy includes recovered energy, which is shown as a credit.

Source: Franklin Associates, A Division of ERG

Table 7-2

## Energy Profile for the Production of GPPS Resin

	<u>MM Btu per 1,000 pounds</u>	<u>GJ per 1,000 kilograms</u>
<b>Energy Source</b>		
Natural Gas	22.4	52.2
Petroleum	16.3	37.9
Coal	1.48	3.44
Hydropower	0.06	0.15
Nuclear	0.55	1.27
Wood	0	0
Other	0.10	0.23
<b>Recovered Energy (1)</b>	<u>-0.004</u>	<u>-0.010</u>
<b>Total Energy</b>	<b>40.9</b>	<b>95.2</b>
<b>Energy Source (Percent)</b>		
Natural Gas	55%	55%
Petroleum	40%	40%
Coal	4%	4%
Hydropower	0%	0%
Nuclear	1%	1%
Wood	0%	0%
Other	<u>0%</u>	<u>0%</u>
<b>Total</b>	<b>100%</b>	<b>100%</b>

(1) Recovered energy represents the recovery of energy as steam or condensate. Because this energy will be used by other processes, it is shown as a negative entry (credit).

Source: Franklin Associates, A Division of ERG

Table 7-3 shows the weight of solid waste generated during the production of GPPS resin. The process solid waste, those wastes produced directly from the cradle-to-resin processes, includes wastes that are incinerated both for disposal and for waste-to-energy, as well as landfilled. These categories have been provided separately. Solid waste from fuel production and combustion is also presented.

Both process and fuel-related, as well as total, atmospheric emissions are shown in Table 7-4. As defined in the report glossary, process emissions are those released directly from the sequence of processes that are used to extract, transform, fabricate, or otherwise affect changes on a material or product during its life cycle, while fuel-related emissions are those associated with the combustion of fuels used for process energy and transportation energy.

Table 7-3

## Solid Wastes by Weight for the Production of GPPS Resin

	<u>lb per 1,000 pounds</u>	<u>kg per 1,000 kilograms</u>
<b>Solid Wastes By Weight</b>		
Process		
Landfilled	38.7	38.7
Incinerated	3.43	3.43
Waste-to-Energy	1.55	1.55
Fuel	<u>66.8</u>	<u>66.8</u>
<b>Total</b>	<b>110</b>	<b>110</b>
 <b>Weight Percent by Category</b>		
Process		
Landfilled	35%	35%
Incinerated	3%	3%
Waste-to-Energy	1%	1%
Fuel	<u>60%</u>	<u>60%</u>
<b>Total</b>	<b>100 %</b>	<b>100 %</b>

Source: Franklin Associates, A Division of ERG

Table 7-5 provides a greenhouse gas (GHG) summary for the production of GPPS resin. The primary three atmospheric emissions reported in this analysis that contribute to global warming are fossil fuel-derived carbon dioxide, methane, and nitrous oxide. (Non-fossil carbon dioxide emissions, such as those from the burning of wood, are considered part of the natural carbon cycle and are not considered a net contributor to global warming.) The 100-year global warming potential for each of these substances as reported in the Intergovernmental Panel on Climate Change (IPCC) 2007 report are shown in a note at the bottom of Table 7-5. The global warming potential represents the relative global warming contribution of a pound of a particular greenhouse gas compared to a pound of carbon dioxide. The weights of each of the contributing emissions in Table 7-4 are multiplied by their global warming potential and shown in Table 7-5.

Both process and fuel-related, as well as the total waterborne emissions are shown in Table 7-6. Definitions of process and fuel-related emissions are provided in this chapter, as well as in the glossary.

Table 7-4

**Atmospheric Emissions for the Production of GPPS Resin**  
**(lb per 1,000 lb or kg per 1,000 kg)**  
 (page 1 of 2)

	Process emissions	Fuel-related emissions	Total emissions
<b>Atmospheric Emissions</b>			
Carbon Dioxide - Fossil	330	2,456	2,787
Methane	6.48	11.2	17.7
Nitrous Oxide	0	0.040	0.040
Carbon Dioxide - Non-Fossil	0	6.47	6.47
Particulates (unspecified)	0.054	0.26	0.31
Particulates (PM10)	0.079	0.31	0.39
Particulates (PM2.5)	0.025	0.22	0.24
Nitrogen Oxides	0.50	5.17	5.67
Sulfur Dioxide	1.08	3.25	4.33
Sulfur Oxides	0.35	1.72	2.07
VOC (unspecified)	0.38	0.58	0.96
TNMOC (unspecified)	0	0.0083	0.0083
Hydrocarbons (unspecified)	0	0.070	0.070
Carbon Monoxide	0.61	1.56	2.17
1,3 Butadiene	0	1.0E-06	1.0E-06
2,4-Dinitrotoluene	0	1.0E-11	1.0E-11
2-Chloroacetophenone	0	2.6E-10	2.6E-10
5-Methyl Chrysene	0	1.7E-09	1.7E-09
Acenaphthene	0	3.9E-08	3.9E-08
Acenaphthylene	0	1.9E-08	1.9E-08
Acetophenone	0	5.5E-10	5.5E-10
acrolein	0	1.6E-04	1.6E-04
Aldehydes (Acetaldehyde)	0	5.9E-05	5.9E-05
Aldehydes (Formaldehyde)	0	0.0015	0.0015
Aldehydes (Propionaldehyde)	0	1.4E-08	1.4E-08
Aldehydes (unspecified)	0	7.3E-05	7.3E-05
Ammonia	0.0026	3.8E-04	0.0030
Ammonia Chloride	0	5.5E-05	5.5E-05
Anthracene	0	1.6E-08	1.6E-08
Antimony	1.5E-06	1.8E-06	3.3E-06
Arsenic	1.9E-07	4.4E-05	4.4E-05
Benzene	0.047	0.051	0.097
Benzo(a)anthracene	0	6.1E-09	6.1E-09
Benzo(a)pyrene	0	2.9E-09	2.9E-09
Benzo(b,j,k)fluoranthene	0	8.4E-09	8.4E-09
Benzo(g,h,i) perylene	0	2.1E-09	2.1E-09
Benzyl Chloride	0	2.6E-08	2.6E-08
Beryllium	0	2.3E-06	2.3E-06
Biphenyl	0	1.3E-07	1.3E-07
Bis(2-ethylhexyl) Phthalate (DEHP)	0	2.7E-09	2.7E-09
Bromoform	0	1.4E-09	1.4E-09
Cadmium	0	1.9E-05	1.9E-05
Carbon Disulfide	0	4.7E-09	4.7E-09
Carbon Tetrachloride	9.9E-07	1.6E-06	2.6E-06
CFC 13 (Methane, trichlorofluoro-)	1.6E-05	2.2E-06	1.8E-05
Chlorobenzene	0	8.0E-10	8.0E-10
Chloroform	0	2.2E-09	2.2E-09
Chlorine	1.3E-04	2.6E-05	1.6E-04
Chromium	4.9E-07	4.2E-05	4.2E-05

Table 7-4

**Atmospheric Emissions for the Production of GPPS Resin**  
(lb per 1,000 lb or kg per 1,000 kg)  
(page 2 of 2)

	Process emissions	Fuel-related emissions	Total emissions
Chromium (VI)	0	6.0E-06	6.0E-06
Chrysene	0	7.6E-09	7.6E-09
Cobalt	0	4.9E-05	4.9E-05
Copper	0	6.3E-07	6.3E-07
Cumene	0	1.9E-10	1.9E-10
Cyanide	0	9.1E-08	9.1E-08
Dimethyl Sulfate	0	1.7E-09	1.7E-09
Dioxins (unspecified)	0	5.6E-08	5.6E-08
Ethyl Chloride	0	1.5E-09	1.5E-09
Ethylbenzene	0.0055	0.0060	0.011
Ethylene Dibromide	3.1E-06	4.3E-07	3.5E-06
Ethylene Dichloride	0	1.5E-09	1.5E-09
Fluoranthene	0	5.4E-08	5.4E-08
Fluorene	0	7.0E-08	7.0E-08
Fluorides	0	6.2E-06	6.2E-06
Furans (unspecified)	0	1.9E-10	1.9E-10
Hydrogen Chloride	5.5E-07	0.098	0.098
Hexane	0	2.4E-09	2.4E-09
Hydrogen Fluoride	0	0.011	0.011
Indeno(1,2,3-cd)pyrene	0	4.7E-09	4.7E-09
Isophorone (C9H14O)	0	2.1E-08	2.1E-08
Kerosene	0	9.9E-05	9.9E-05
Lead	0	5.1E-05	5.1E-05
Magnesium	0	8.4E-04	8.4E-04
Manganese	0	1.2E-04	1.2E-04
Mercaptan	0	7.3E-06	7.3E-06
Mercury	0	1.0E-05	1.0E-05
Metals (unspecified)	0	0.0014	0.0014
Methyl Bromide	0	5.8E-09	5.8E-09
Methyl Chloride	0	1.9E-08	1.9E-08
Methyl Ethyl Ketone	2.6E-04	1.4E-08	2.6E-04
Methyl Hydrazine	0	6.2E-09	6.2E-09
Methyl Methacrylate	0	7.3E-10	7.3E-10
Methyl Tert Butyl Ether (MTBE)	0	1.3E-09	1.3E-09
Methylene Chloride	0	6.8E-05	6.8E-05
Naphthalene	0	1.9E-05	1.9E-05
Nickel	4.2E-06	6.1E-04	6.1E-04
Organics (unspecified)	0.011	4.7E-04	0.011
Perchloroethylene	0	3.8E-06	3.8E-06
Phenanthrene	0	2.1E-07	2.1E-07
Phenols	0	3.0E-05	3.0E-05
Polyaromatic Hydrocarbons (total)	4.1E-05	1.2E-05	5.2E-05
Propylene	0	6.7E-05	6.7E-05
Pyrene	0	2.5E-08	2.5E-08
Radionuclides (unspecified) (1)	0	0.0056	0.0056
Selenium	0	1.1E-04	1.1E-04
Styrene	0	9.1E-10	9.1E-10
Toluene	0.071	0.077	0.15
Trichloroethane	0	7.3E-10	7.3E-10
Vinyl Acetate	0	2.8E-10	2.8E-10
Xylenes	0.041	0.045	0.086
Zinc	0	4.2E-07	4.2E-07
HCFC-22	0.0010	0	0.0010
Hydrogen	0.0026	0	0.0026
NMVOOC, non-methane volatile organic compounds, unspecified origin	0.49	0	0.49
Non-Methane Hydrocarbons	0.19	0	0.19

(1) The units for Radionuclides are Curies per 1,000 lbs of product. The total Radionuclides using metric units are 456,200 kBq per 1,000 kgs of product.

Source: Franklin Associates, A Division of ERG

Table 7-5

**Greenhouse Gas Summary for the Production of GPPS Resin**  
 (lb carbon dioxide equivalents per 1,000 lb GPPS or kg carbon dioxide equivalents per 1,000 kg GPPS)

	<u>Fuel-related CO2 Equiv.</u>	<u>Process CO2 Equiv.</u>	<u>Total CO2 Equiv.</u>
Carbon Dioxide - Fossil	2,456	330	2,787
Methane	281	162	443
Nitrous Oxide	11.9	0	11.9
Methyl Bromide	2.9E-08	0	2.9E-08
Methyl Chloride	3.1E-07	0	3.1E-07
Trichloroethane	1.0E-07	0	1.0E-07
Chloroform	6.5E-08	0	6.5E-08
Methylene Chloride	6.8E-04	0	6.8E-04
Carbon Tetrachloride	0.0023	0.0014	0.0037
CFC 13 (Methane, trichlorofluor	0.026	0.19	0.21
HCFC-22	0	1.81	1.81
Total	<u>2,749</u>	<u>493</u>	<u>3,242</u>

Note: The 100 year global warming potentials used in this table are as follows: fossil carbon dioxide--1, methane--25, nitrous oxide--298, methyl bromide--5, methyl chloride--16, trichloroethane--140, chloroform--30, methylene chloride--10, carbon tetrachloride--1400, CFC-013--11,700, HCFC-22--1810, HCFC-123--77, and HFC-134a--1430.

Source: Franklin Associates, A Division of ERG

Table 7-6

**Waterborne Emissions for the Production of GPPS Resin**  
**(lb per 1,000 lb or kg per 1,000 kg)**  
 (page 1 of 2)

	Process emissions	Fuel-related emissions	Total emissions
<b>Waterborne Wastes</b>			
1-methylfluorene	1.3E-08	1.1E-08	2.4E-08
2,4 dimethylphenol	8.0E-06	4.4E-06	1.2E-05
2-Hexanone	1.9E-06	1.0E-06	2.9E-06
2-methyl naphthalene	4.3E-06	2.4E-06	6.7E-06
4-methyl-2-pentanone	4.9E-07	4.0E-07	9.0E-07
Acetone	1.2E-06	9.6E-07	2.1E-06
Acid (benzoic)	2.9E-04	1.6E-04	4.5E-04
Acid (hexanoic)	6.0E-05	3.3E-05	9.3E-05
Alkylated Benzenes	5.4E-05	2.9E-05	8.4E-05
Alkylated Fluorenes	3.2E-06	1.7E-06	4.8E-06
Alkylated Naphthalenes	8.9E-07	4.8E-07	1.4E-06
Alkylated Phenanthrenes	3.7E-07	2.0E-07	5.7E-07
Aluminum	0.027	0.015	0.041
Ammonia	0.015	0.0031	0.018
Ammonium	0	4.4E-05	4.4E-05
Antimony	1.7E-05	8.9E-06	2.6E-05
Arsenic	5.7E-05	3.1E-05	8.7E-05
Barium	0.36	0.19	0.55
Benzene	3.2E-04	1.6E-04	4.9E-04
Beryllium	3.6E-06	1.9E-06	5.4E-06
BOD	0.42	0.083	0.50
Boron	8.9E-04	4.9E-04	0.0014
Bromide	0.037	0.019	0.056
Cadmium	8.8E-06	5.2E-06	1.4E-05
Calcium	0.61	0.31	0.93
Chlorides (methyl chloride)	4.7E-09	3.9E-09	8.6E-09
Chlorides (unspecified)	0	3.92	3.92
Chromium (unspecified)	7.3E-04	3.8E-04	0.0011
Cobalt	6.3E-06	3.5E-06	9.8E-06
COD	1.07	0.049	1.12
Copper	7.8E-05	5.5E-05	1.3E-04
Cresols	1.7E-05	9.3E-06	2.6E-05
Cyanide	1.0E-06	6.9E-09	1.0E-06
Cymene	1.2E-08	9.6E-09	2.1E-08
Dibenzofuran	2.2E-08	1.8E-08	4.1E-08
Dibenzothiophene	1.8E-08	1.5E-08	3.3E-08
Dissolved Solids	8.86	3.92	12.8
Ethylbenzene	0.0010	9.1E-06	0.0010
Fluorine/Fluorides	1.5E-06	7.2E-04	7.2E-04
Hydrocarbons	1.0E-05	3.1E-05	4.1E-05
Iron	0.050	0.030	0.079
Lead	1.6E-04	8.0E-05	2.4E-04
Lithium	0.072	0.078	0.15
Magnesium	0.12	0.063	0.18
Manganese	1.8E-04	0.0011	0.0013
Mercury	3.4E-07	1.8E-07	5.1E-07
Methyl Ethyl Ketone (MEK)	9.5E-09	7.8E-09	1.7E-08
Molybdenum	6.6E-06	3.6E-06	1.0E-05



Table 7-6

**Waterborne Emissions for the Production of GPPS Resin**  
**(lb per 1,000 lb or kg per 1,000 kg)**  
 (page 2 of 2)

	Process emissions	Fuel-related emissions	Total emissions
Naphthalene	5.2E-06	2.8E-06	8.0E-06
Nickel	7.8E-05	3.6E-05	1.1E-04
Nitrates	0	1.1E-04	1.1E-04
Nitrogen (ammonia)	0	3.9E-05	3.9E-05
Oil	0.027	0.0039	0.031
Pentamethyl benzene	8.8E-09	7.2E-09	1.6E-08
Phenanthrene	2.3E-07	1.2E-07	3.5E-07
Phenol/Phenolic Compounds	8.1E-04	6.9E-05	8.8E-04
Radionuclides (unspecified) (1)	0	7.8E-08	7.8E-08
Selenium	4.4E-06	1.7E-05	2.2E-05
Silver	3.8E-04	1.9E-04	5.7E-04
Sodium	1.78	0.90	2.67
Strontium	0.016	0.0085	0.024
Sulfates	0.013	0.078	0.091
Sulfides	9.2E-04	1.9E-05	9.4E-04
Sulfur	7.0E-04	3.9E-04	0.0011
Surfactants	1.5E-04	7.7E-05	2.3E-04
Suspended Solids	2.98	1.59	4.57
Thallium	3.5E-06	1.9E-06	5.4E-06
Tin	6.6E-05	3.6E-05	1.0E-04
Titanium	2.6E-04	1.4E-04	3.9E-04
Toluene	3.5E-04	1.5E-04	5.0E-04
Total Alkalinity	0.014	0.0070	0.021
Total Biphenyls	3.5E-06	1.9E-06	5.4E-06
Total Dibenzo-thiophenes	1.1E-08	5.8E-09	1.7E-08
Vanadium	4.7E-05	9.5E-06	5.6E-05
Xylenes	1.5E-04	7.8E-05	2.3E-04
Yttrium	1.9E-06	1.0E-06	3.0E-06
Zinc	6.2E-04	3.5E-04	9.7E-04
Chromium (hexavalent)	2.3E-07	0	2.3E-07
Lead 210	3.0E-14	0	3.0E-14
n-Decane	8.3E-06	0	8.3E-06
n-Docosane	1.3E-07	0	1.3E-07
n-Dodecane	1.6E-05	0	1.6E-05
n-Eicosane	4.3E-06	0	4.3E-06
n-Hexacosane	7.8E-08	0	7.8E-08
n-Hexadecane	1.7E-05	0	1.7E-05
n-Octadecane	4.3E-06	0	4.3E-06
Phosphates	0.0010	0	0.0010
Radium 226	1.0E-11	0	1.0E-11
Radium 228	5.3E-14	0	5.3E-14
Styrene	0.0010	0	0.0010
Tetradecane	6.6E-06	0	6.6E-06
TOC	5.6E-04	0	5.6E-04

(1) The units for Radionuclides are Curies per 1,000 lbs of product. The total Radionuclides using metric units are 6.38 kBq per 1,000 kgs of product.

Source: Franklin Associates, A Division of ERG

## CHAPTER 8

## CRADLE-TO-RESIN LIFE CYCLE INVENTORY RESULTS FOR HIPS RESIN

This chapter presents LCI results for the production of high-impact polystyrene (HIPS) resin (cradle-to-resin). The results are given on the bases of 1,000 pounds and 1,000 kilograms of HIPS resin. Figure 8-1 presents the flow diagram for the production of HIPS resin. Process descriptions and individual process tables for each box shown in the flow diagram can be found in Appendix H of the Appendices (separate document).

Primary data was collected for olefins and HIPS resin production. The olefins dataset was also used for butadiene, which is a coproduct of the olefins hydrocracker. As of 2002, almost all butadiene is produced as an ethylene steam-cracking coproduct.

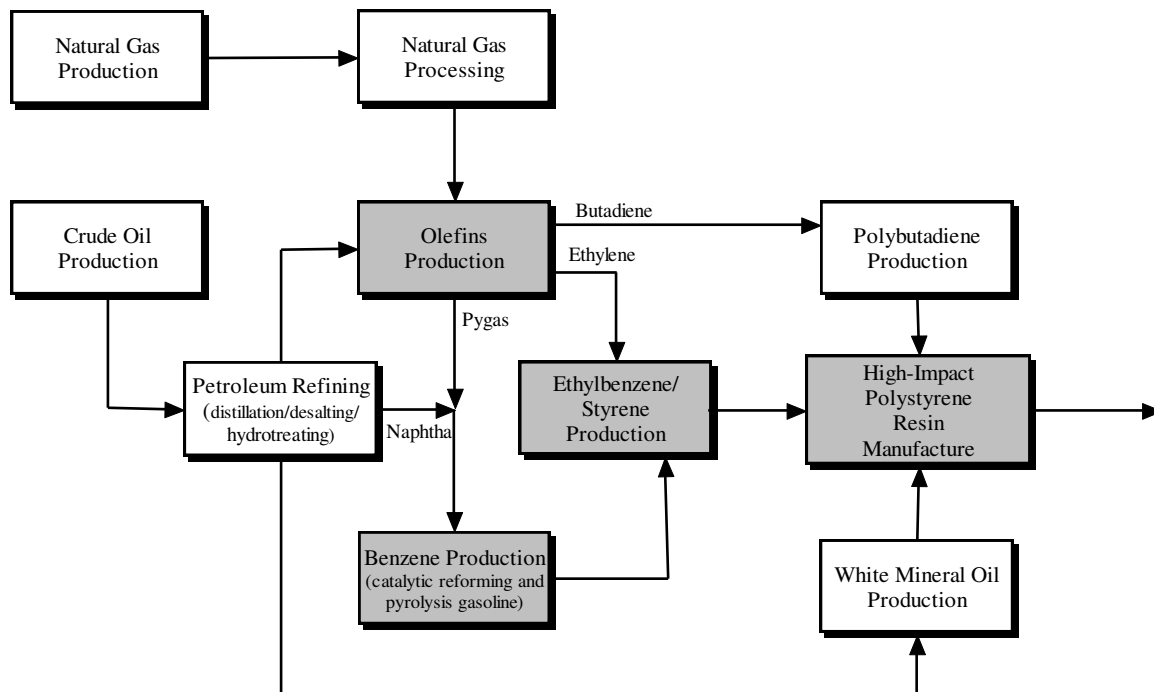

Figure 8-1. Flow diagram for the production of high-impact polystyrene resin. Shaded boxes represent partial or complete data provided by manufacturers specifically for this analysis.

A weighted average using production quantities was calculated from the olefins production data collected from three leading producers (8 thermal cracking units) in North America. As of 2003, there were 16 olefin producers and at least 29 olefin plants in the U.S. The captured production amount is approximately 30 percent of the available capacity for olefin production. Numerous coproduct streams are produced from the olefins hydrocracker. Fuel gas and off-gas were two of the coproducts produced that were exported to another process for fuel. When these fuel coproducts are exported from the hydrocracker, they carry with them the allocated share of the inputs and outputs for their production. The separate appendices provide an in-depth discussion of this allocation. A mass basis was used to allocate the credit to the remaining material coproducts.

A weighted average using production amounts was calculated from the HIPS production data from six plants collected from four leading producers in North America. As of 2002 there were 12 PS producers and 24 PS plants in the U.S. The captured production amount is approximately 25 percent of the available capacity for all polystyrene production in the U.S. and Canada. Scrap resin (e.g. off-spec) is produced as a coproduct during this process. A mass basis was used to allocate the credit for the scrap.

## DESCRIPTION OF TABLES

The average gross energy required to produce HIPS resin is 41.3 million Btu per 1,000 pounds of resin or 96.1 GJ per 1,000 kilograms of resin. Tables 8-1 and 8-2 show the breakdown of energy requirements for the production of HIPS resin by category and source, respectively. Precombustion energy (the energy used to extract and process fuels used for process energy and transportation energy) is included in the results shown in these tables. Table H-1 in the Appendices (separate document) provides the aggregated unit process energy (cradle-to-resin) for the production of HIPS resin. Natural gas and petroleum used as raw material inputs for the production of HIPS, reported as energy of material resource in Table 8-1, are included in the totals for natural gas and petroleum energy in Table 8-2. Petroleum-based fuels (e.g. diesel fuel) are the dominant energy source for transportation. Non-fossil sources, such as hydropower, nuclear and other (geothermal, wind, etc.) shown in Table 8-2 are used to generate purchased electricity along with the fossil fuels.

Table 8-3 shows the weight of solid waste generated during the production of HIPS resin. The process solid waste, those wastes produced directly from the cradle-to-resin processes, includes wastes that are incinerated both for disposal and for waste-to-energy, as well as landfilled. These categories have been provided separately. Solid waste from fuel production and combustion is also presented.

Both process and fuel-related, as well as total, atmospheric emissions are shown in Table 8-4. As defined in the report glossary, process emissions are those released directly from the sequence of processes that are used to extract, transform, fabricate, or otherwise affect changes on a material or product during its life cycle, while fuel-related emissions are those associated with the combustion of fuels used for process energy and transportation energy.

Table 8-1

## Energy by Category for the Production of HIPS Resin

	<u>MMBtu per 1,000 pounds</u>	<u>GJ per 1,000 kilograms</u>
<b>Energy Category</b>		
Process (1)	18.2	42.3
Transportation	1.19	2.76
Energy of Material Resource	<u>22.0</u>	<u>51.1</u>
<b>Total Energy</b>	<b>41.3</b>	<b>96.1</b>
<b>Energy Category (Percent)</b>		
Process	44%	44%
Transportation	3%	3%
Energy of Material Resource	<u>53%</u>	<u>53%</u>
<b>Total</b>	<b>100%</b>	<b>100%</b>

---

(1) Process energy includes recovered energy, which is shown as a credit.

Source: Franklin Associates, A Division of ERG

Table 8-2

## Energy Profile for the Production of HIPS Resin

	<u>MM Btu per 1,000 pounds</u>	<u>GJ per 1,000 kilograms</u>
<b>Energy Source</b>		
Natural Gas	22.7	52.9
Petroleum	16.4	38.1
Coal	1.51	3.51
Hydropower	0.066	0.15
Nuclear	0.56	1.30
Wood	0	0
Other	0.10	0.24
<b>Recovered Energy (1)</b>	<u>-0.004</u>	<u>-0.010</u>
<b>Total Energy</b>	<b>41.3</b>	<b>96.2</b>
<b>Energy Source (Percent)</b>		
Natural Gas	55%	55%
Petroleum	40%	40%
Coal	4%	4%
Hydropower	0%	0%
Nuclear	1%	1%
Wood	0%	0%
Other	<u>0%</u>	<u>0%</u>
<b>Total</b>	<b>100%</b>	<b>100%</b>

(1) Recovered energy represents the recovery of energy as steam or condensate. Because this energy will be used by other processes, it is shown as a negative entry (credit).

Source: Franklin Associates, A Division of ERG

Table 8-3

## Solid Wastes by Weight for the Production of HIPS Resin

	<u>lb per 1,000 pounds</u>	<u>kg per 1,000 kilograms</u>
<b>Solid Wastes By Weight</b>		
Process		
Landfilled	41.6	41.6
Incinerated	3.72	3.72
Waste-to-Energy	1.15	1.15
Fuel	<u>67.6</u>	<u>67.6</u>
<b>Total</b>	<b>114</b>	<b>114</b>
<b>Weight Percent by Category</b>		
Process		
Landfilled	36%	36%
Incinerated	3%	3%
Waste-to-Energy	1%	1%
Fuel	<u>59%</u>	<u>59%</u>
<b>Total</b>	<b>100 %</b>	<b>100 %</b>

Source: Franklin Associates, A Division of ERG

Table 8-5 provides a greenhouse gas (GHG) summary for the production of HIPS resin. The primary three atmospheric emissions reported in this analysis that contribute to global warming are fossil fuel-derived carbon dioxide, methane, and nitrous oxide. (Non-fossil carbon dioxide emissions, such as those from the burning of wood, are considered part of the natural carbon cycle and are not considered a net contributor to global warming.) The 100-year global warming potential for each of these substances as reported in the Intergovernmental Panel on Climate Change (IPCC) 2007 report are shown in a note at the bottom of Table 8-5. The global warming potential represents the relative global warming contribution of a pound of a particular greenhouse gas compared to a pound of carbon dioxide. The weights of each of the contributing emissions in Table 8-4 are multiplied by their global warming potential and shown in Table 8-5.

Both process and fuel-related, as well as the total waterborne emissions are shown in Table 8-6. Definitions of process and fuel-related emissions are provided in this chapter, as well as in the glossary.

Table 8-4

**Atmospheric Emissions for the Production of HIPS Resin**  
**(lb per 1,000 lb or kg per 1,000 kg)**  
 (page 1 of 2)

	Process emissions	Fuel-related emissions	Total emissions
<b>Atmospheric Emissions</b>			
Carbon Dioxide - Fossil	313	2,486	2,799
Methane	6.58	11.3	17.9
Nitrous Oxide	0	0.040	0.040
Carbon Dioxide - Non-Fossil	0	6.59	6.59
Particulates (unspecified)	0.044	0.26	0.31
Particulates (PM10)	0.092	0.31	0.41
Particulates (PM2.5)	0.024	0.22	0.24
Nitrogen Oxides	0.49	5.25	5.74
Sulfur Dioxide	1.12	3.27	4.40
Sulfur Oxides	0.33	1.75	2.07
VOC (unspecified)	0.40	0.58	0.98
TNMOC (unspecified)	0	0.0085	0.0085
Hydrocarbons (unspecified)	0	0.072	0.072
Carbon Monoxide	0.58	1.57	2.15
1,3 Butadiene	0	1.0E-06	1.0E-06
2,4-Dinitrotoluene	0	1.0E-11	1.0E-11
2-Chloroacetophenone	0	2.6E-10	2.6E-10
5-Methyl Chrysene	0	1.7E-09	1.7E-09
Acenaphthene	0	4.0E-08	4.0E-08
Acenaphthylene	0	1.9E-08	1.9E-08
Acetophenone	0	5.6E-10	5.6E-10
acrolein	0	1.6E-04	1.6E-04
Aldehydes (Acetaldehyde)	0	5.9E-05	5.9E-05
Aldehydes (Formaldehyde)	0	0.0015	0.0015
Aldehydes (Propionaldehyde)	0	1.4E-08	1.4E-08
Aldehydes (unspecified)	0	7.5E-05	7.5E-05
Ammonia	0.0026	3.9E-04	0.0030
Ammonia Chloride	0	5.6E-05	5.6E-05
Anthracene	0	1.6E-08	1.6E-08
Antimony	1.5E-06	1.9E-06	3.4E-06
Arsenic	1.9E-07	4.4E-05	4.4E-05
Benzene	0.049	0.050	0.099
Benzo(a)anthracene	0	6.2E-09	6.2E-09
Benzo(a)pyrene	0	3.0E-09	3.0E-09
Benzo(b,j,k)fluoranthene	0	8.6E-09	8.6E-09
Benzo(g,h,i) perylene	0	2.1E-09	2.1E-09
Benzyl Chloride	0	2.6E-08	2.6E-08
Beryllium	0	2.3E-06	2.3E-06
Biphenyl	0	1.3E-07	1.3E-07
Bis(2-ethylhexyl) Phthalate (DEHP)	0	2.7E-09	2.7E-09
Bromoform	0	1.4E-09	1.4E-09
Cadmium	0	1.9E-05	1.9E-05
Carbon Disulfide	0	4.8E-09	4.8E-09
Carbon Tetrachloride	9.9E-07	1.7E-06	2.7E-06
CFC 13 (Methane, trichlorofluoro-)	1.6E-05	2.3E-06	1.8E-05
Chlorobenzene	0	8.2E-10	8.2E-10
Chloroform	0	2.2E-09	2.2E-09
Chlorine	1.3E-04	2.7E-05	1.5E-04
Chromium	4.9E-07	4.2E-05	4.3E-05

Table 8-4

**Atmospheric Emissions for the Production of HIPS Resin**  
(lb per 1,000 lb or kg per 1,000 kg)  
(page 2 of 2)

	Process emissions	Fuel-related emissions	Total emissions
Chromium (VI)	0	6.1E-06	6.1E-06
Chrysene	0	7.8E-09	7.8E-09
Cobalt	0	5.0E-05	5.0E-05
Copper	0	6.2E-07	6.2E-07
Cumene	0	2.0E-10	2.0E-10
Cyanide	0	9.3E-08	9.3E-08
Dimethyl Sulfate	0	1.8E-09	1.8E-09
Dioxins (unspecified)	0	5.7E-08	5.7E-08
Ethyl Chloride	0	1.6E-09	1.6E-09
Ethylbenzene	0.0057	0.0059	0.012
Ethylene Dibromide	3.1E-06	4.5E-07	3.6E-06
Ethylene Dichloride	0	1.5E-09	1.5E-09
Fluoranthene	0	5.5E-08	5.5E-08
Fluorene	0	7.1E-08	7.1E-08
Fluorides	0	6.3E-06	6.3E-06
Furans (unspecified)	0	2.0E-10	2.0E-10
Hydrogen Chloride	5.2E-07	0.10	0.10
Hexane	0	2.5E-09	2.5E-09
Hydrogen Fluoride	0	0.012	0.012
Indeno(1,2,3-cd)pyrene	0	4.7E-09	4.7E-09
Isophorone (C9H14O)	0	2.2E-08	2.2E-08
Kerosene	0	1.0E-04	1.0E-04
Lead	0	5.1E-05	5.1E-05
Magnesium	0	8.6E-04	8.6E-04
Manganese	0	1.2E-04	1.2E-04
Mercaptan	0	7.4E-06	7.4E-06
Mercury	0	1.1E-05	1.1E-05
Metals (unspecified)	0	0.0014	0.0014
Methyl Bromide	0	5.9E-09	5.9E-09
Methyl Chloride	0	2.0E-08	2.0E-08
Methyl Ethyl Ketone	0.0018	1.4E-08	0.0018
Methyl Hydrazine	0	6.3E-09	6.3E-09
Methyl Methacrylate	0	7.4E-10	7.4E-10
Methyl Tert Butyl Ether (MTBE)	0	1.3E-09	1.3E-09
Methylene Chloride	0	6.9E-05	6.9E-05
Naphthalene	0	1.9E-05	1.9E-05
Nickel	4.2E-06	6.2E-04	6.3E-04
Organics (unspecified)	0.010	4.8E-04	0.010
Perchloroethylene	0	3.9E-06	3.9E-06
Phenanthrene	0	2.1E-07	2.1E-07
Phenols	0	3.0E-05	3.0E-05
Polyaromatic Hydrocarbons (total)	4.1E-05	1.2E-05	5.3E-05
Propylene	0	6.8E-05	6.8E-05
Pyrene	0	2.6E-08	2.6E-08
Radionuclides (unspecified) (1)	0	0.0057	0.0057
Selenium	0	1.1E-04	1.1E-04
Styrene	0	9.3E-10	9.3E-10
Toluene	0.074	0.076	0.15
Trichloroethane	0	7.4E-10	7.4E-10
Vinyl Acetate	0	2.8E-10	2.8E-10
Xylenes	0.043	0.044	0.088
Zinc	0	4.1E-07	4.1E-07
Acid (unknown)	1.0E-06	0	1.0E-06
HCFC-22	0.0010	0	0.0010
Hydrogen	0.0024	0	0.0024
NM VOC, non-methane volatile organic compounds, unspecified origin	0.49	0	0.49
Non-Methane Hydrocarbons	0.93	0	0.93

(1) The units for Radionuclides are Curies per 1,000 lbs of product. The total Radionuclides using metric units are 464,300 kBq per 1,000 kgs of product.

Source: Franklin Associates, A Division of ERG



Table 8-5

**Greenhouse Gas Summary for the Production of HIPS Resin**  
**(lb carbon dioxide equivalents per 1,000 lb HIPS or kg carbon dioxide equivalents per 1,000 kg HIPS)**

	<u>Fuel-related CO2 Equiv.</u>	<u>Process CO2 Equiv.</u>	<u>Total CO2 Equiv.</u>
Carbon Dioxide - Fossil	2,486	313	2,799
Methane	283	165	448
Nitrous Oxide	11.9	0	11.9
Methyl Bromide	3.0E-08	0	3.0E-08
Methyl Chloride	3.1E-07	0	3.1E-07
Trichloroethane	1.0E-07	0	1.0E-07
Chloroform	6.6E-08	0	6.6E-08
Methylene Chloride	6.9E-04	0	6.9E-04
Carbon Tetrachloride	0.0023	0.0014	0.0037
CFC 13 (Methane, trichlorofluor	0.027	0.19	0.21
HCFC-22	0	1.81	1.81
Total	<u>2,781</u>	<u>478</u>	<u>3,259</u>

Note: The 100 year global warming potentials used in this table are as follows: fossil carbon dioxide--1, methane--25, nitrous oxide--298, methyl bromide--5, methyl chloride--16, trichloroethane--140, chloroform--30, methylene chloride--10, carbon tetrachloride--1400, CFC-013--11,700, HCFC-22--1810, HCFC-123--77, and HFC-134a--1430.

Source: Franklin Associates, A Division of ERG

Table 8-6

**Waterborne Emissions for the Production of HIPS Resin**  
**(lb per 1,000 lb or kg per 1,000 kg)**  
 (page 1 of 2)

	Process emissions	Fuel-related emissions	Total emissions
<b>Waterborne Wastes</b>			
1-methylfluorene	1.4E-08	1.1E-08	2.5E-08
2,4 dimethylphenol	8.2E-06	4.3E-06	1.2E-05
2-Hexanone	1.9E-06	1.0E-06	2.9E-06
2-methyl naphthalene	4.4E-06	2.4E-06	6.8E-06
4-methyl-2-pentanone	5.1E-07	4.0E-07	9.1E-07
Acetone	1.2E-06	9.5E-07	2.2E-06
Acid (benzoic)	3.0E-04	1.6E-04	4.5E-04
Acid (hexanoic)	6.1E-05	3.2E-05	9.4E-05
Alkylated Benzenes	5.5E-05	2.9E-05	8.4E-05
Alkylated Fluorenes	3.2E-06	1.7E-06	4.9E-06
Alkylated Naphthalenes	9.1E-07	4.7E-07	1.4E-06
Alkylated Phenanthrenes	3.8E-07	2.0E-07	5.7E-07
Aluminum	0.027	0.015	0.042
Ammonia	0.015	0.0032	0.018
Ammonium	0	4.5E-05	4.5E-05
Antimony	1.7E-05	8.9E-06	2.6E-05
Arsenic	5.8E-05	3.0E-05	8.8E-05
Barium	0.37	0.19	0.56
Benzene	3.3E-04	1.6E-04	4.9E-04
Beryllium	3.6E-06	1.8E-06	5.5E-06
BOD	0.42	0.084	0.51
Boron	9.1E-04	4.8E-04	0.0014
Bromide	0.038	0.019	0.057
Cadmium	8.9E-06	5.2E-06	1.4E-05
Calcium	0.62	0.31	0.94
Chlorides (methyl chloride)	4.9E-09	3.8E-09	8.7E-09
Chlorides (unspecified)	0	3.89	3.89
Chromium (unspecified)	7.6E-04	3.8E-04	0.0011
Cobalt	6.4E-06	3.4E-06	9.9E-06
COD	1.07	0.050	1.12
Copper	7.9E-05	5.5E-05	1.3E-04
Cresols	1.7E-05	9.2E-06	2.7E-05
Cyanide	1.0E-06	6.9E-09	1.0E-06
Cymene	1.2E-08	9.5E-09	2.2E-08
Dibenzofuran	2.3E-08	1.8E-08	4.1E-08
Dibenzothiophene	1.9E-08	1.5E-08	3.3E-08
Dissolved Solids	10.5	3.90	14.4
Ethylbenzene	9.6E-04	9.1E-06	9.7E-04
Fluorine/Fluorides	1.5E-06	7.3E-04	7.3E-04
Hydrocarbons	0	3.1E-05	3.1E-05
Iron	0.051	0.030	0.080
Lead	1.6E-04	7.9E-05	2.4E-04
Lithium	0.075	0.077	0.15
Magnesium	0.12	0.063	0.19
Manganese	1.8E-04	0.0011	0.0013
Mercury	3.4E-07	1.8E-07	5.2E-07
Methyl Ethyl Ketone (MEK)	9.8E-09	7.7E-09	1.7E-08
Molybdenum	6.7E-06	3.5E-06	1.0E-05

Table 8-6

**Waterborne Emissions for the Production of HIPS Resin**  
**(lb per 1,000 lb or kg per 1,000 kg)**  
 (page 2 of 2)

	Process emissions	Fuel-related emissions	Total emissions
Naphthalene	5.3E-06	2.8E-06	8.1E-06
Nickel	7.9E-05	3.5E-05	1.1E-04
Nitrates	0	1.1E-04	1.1E-04
Nitrogen (ammonia)	0	3.9E-05	3.9E-05
Oil	0.031	0.0040	0.035
Pentamethyl benzene	9.1E-09	7.1E-09	1.6E-08
Phenanthrene	2.3E-07	1.2E-07	3.6E-07
Phenol/Phenolic Compounds	8.6E-04	7.0E-05	9.3E-04
Radionuclides (unspecified) (1)	0	8.0E-08	8.0E-08
Selenium	4.4E-06	1.8E-05	2.2E-05
Silver	3.8E-04	1.9E-04	5.7E-04
Sodium	1.81	0.89	2.70
Strontium	0.016	0.0084	0.024
Sulfates	0.013	0.080	0.093
Sulfides	8.7E-04	2.0E-05	8.9E-04
Sulfur	7.1E-04	3.9E-04	0.0011
Surfactants	1.5E-04	7.7E-05	2.3E-04
Suspended Solids	3.14	1.58	4.72
Thallium	3.6E-06	1.9E-06	5.4E-06
Tin	6.7E-05	3.5E-05	1.0E-04
Titanium	2.6E-04	1.4E-04	4.0E-04
Toluene	3.6E-04	1.5E-04	5.1E-04
Total Alkalinity	0.014	0.0069	0.021
Total Biphenyls	3.6E-06	1.9E-06	5.5E-06
Total Dibenzo-thiophenes	1.1E-08	5.8E-09	1.7E-08
Vanadium	4.7E-05	9.7E-06	5.6E-05
Xylenes	1.6E-04	7.8E-05	2.4E-04
Yttrium	2.0E-06	1.0E-06	3.0E-06
Zinc	0.061	3.4E-04	0.061
Chromium (hexavalent)	1.6E-06	0	1.6E-06
Lead 210	3.0E-14	0	3.0E-14
n-Decane	8.4E-06	0	8.4E-06
n-Docosane	1.3E-07	0	1.3E-07
n-Dodecane	1.6E-05	0	1.6E-05
n-Eicosane	4.4E-06	0	4.4E-06
n-Hexacosane	8.1E-08	0	8.1E-08
n-Hexadecane	1.7E-05	0	1.7E-05
n-Octadecane	4.3E-06	0	4.3E-06
Phosphates	0.0010	0	0.0010
Radium 226	1.1E-11	0	1.1E-11
Radium 228	5.4E-14	0	5.4E-14
Styrene	9.4E-04	0	9.4E-04
Tetradecane	6.8E-06	0	6.8E-06
TOC	5.9E-04	0	5.9E-04

(1) The units for Radionuclides are Curies per 1,000 lbs of product. The total Radionuclides using metric units are 6.50 kBq per 1,000 kgs of product.

Source: Franklin Associates, A Division of ERG

## CHAPTER 9

## CRADLE-TO-RESIN LIFE CYCLE INVENTORY RESULTS FOR PVC RESIN

This chapter presents LCI results for the production of polyvinyl chloride (PVC) resin (cradle-to-resin). The results are given on the bases of 1,000 pounds and 1,000 kilograms of PVC resin. Figure 9-1 presents the flow diagram for the production of PVC resin. Process descriptions and individual process tables for each box shown in the flow diagram can be found in Appendix I of the Appendices (separate document).

No fillers, additives, or plasticizers are included in this analysis; therefore, no compounding process is included.

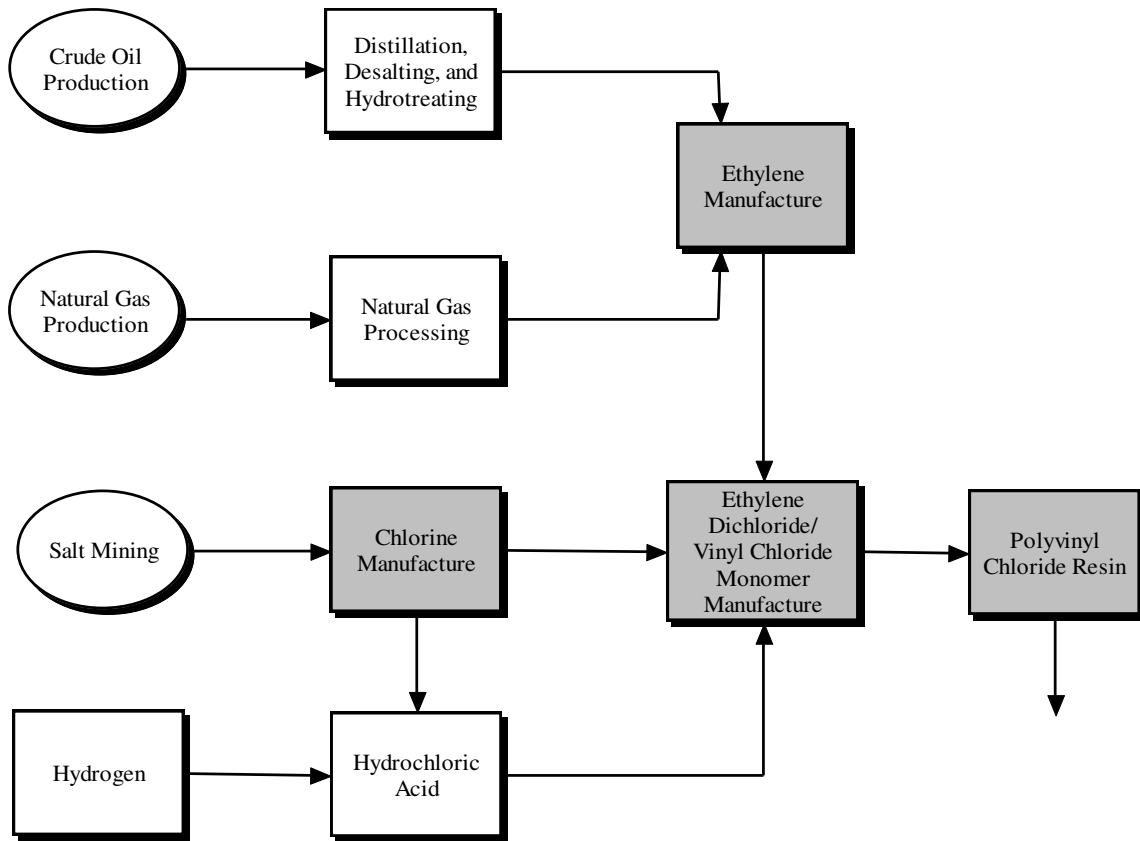

Figure 9-1. Flow diagram for the manufacture of polyvinyl chloride (PVC) resin. Shaded boxes represent partial or complete data provided by manufacturers specifically for this analysis.

Primary data was collected for olefins, chlorine/caustic soda, EDC/VCM, and PVC resin production. A weighted average using production quantities was calculated from the olefins production data collected from three leading producers (8 thermal cracking units) in North America. As of 2003, there were 16 olefin producers and at least 29 olefin plants in the U.S. The captured production amount is approximately 30 percent of the available capacity for olefin production. Numerous coproduct streams are produced from the olefins hydrocracker. Fuel gas and off-gas were two of the coproducts produced that were exported to another process for fuel. When these fuel coproducts are exported from the hydrocracker, they carry with them the allocated share of the inputs and outputs for their production. The separate appendices provide an in-depth discussion of this allocation. A mass basis was used to allocate the credit to the remaining material coproducts.

The chlorine/caustic data collected for this module represent 1 producer and 3 plants in the U.S. Besides this recently collected data, 2 diaphragm cell datasets and 2 mercury cell datasets were used from the early 1990s. According to a study performed by Chemical Market Associates, Inc. (CMAI), the approximate amount of chlorine from mercury cell technology going into EDC production is 1.4 percent. The collected datasets were weighted using 1.4 percent mercury cell technology and 98.6 percent diaphragm/membrane cell technology. As of 2003 there were 20 chlorine/caustic producers and 41 chlorine/caustic plants in the U.S. for the three standard technologies. The captured production amount is approximately 30 percent of the available capacity for all chlorine production in the U.S. Caustic soda and hydrogen are the coproducts produced with chlorine. A mass basis was used to allocate the credit to the coproducts.

A weighted average using production amounts was calculated from the EDC/VCM production data from three plants collected from three leading producers in North America. As of 2003, there were 8 VCM producers and 12 VCM plants in the U.S. The captured production amount is approximately 50 percent of the available capacity for VCM production in the U.S. Dichloroethane is produced as a coproduct during this process. A mass basis was used to allocate the credit for the coproduct.

A weighted average using production amounts was calculated from the PVC production data from three plants collected from three leading producers in North America. As of 2003, there were 12 PVC producers and 25 PVC plants in the U.S. The captured production amount is approximately 35 percent of the available capacity for PVC production in the U.S. and Canada. Scrap resin (e.g. off-spec) is produced as a coproduct during this process. A mass basis was used to allocate the credit for the coproduct.

## DESCRIPTION OF TABLES

The average gross energy required to produce PVC resin is 25.5 million Btu per 1,000 pounds of resin or 59.2 GJ per 1,000 kilograms of resin. Tables 9-1 and 9-2 show the breakdown of energy requirements for the production of PVC resin by category and source, respectively. Precombustion energy (the energy used to extract and process fuels used for process energy and transportation energy) is included in the results shown in these tables. Table I-1 in the Appendices (separate document) provides the aggregated unit process energy (cradle-to-resin) for the production of PVC resin. Natural gas and petroleum used as raw material inputs for the production of PVC, reported as energy of material resource in Table 9-1, are included in the totals for natural gas and petroleum energy in Table 9-2. Petroleum-based fuels (e.g. diesel fuel) are the dominant energy source for transportation. Non-fossil sources, such as hydropower, nuclear and other (geothermal, wind, etc.) shown in Table 9-2 are used to generate purchased electricity along with the fossil fuels.

Table 9-3 shows the weight of solid waste generated during the production of PVC resin. The process solid waste, those wastes produced directly from the cradle-to-resin processes, includes wastes that are incinerated both for disposal and for waste-to-energy, as well as landfilled. These categories have been provided separately. Solid waste from fuel production and combustion is also presented.

**Table 9-1**

### Energy by Category for the Production of PVC Resin

	<u>MMBtu per 1,000 pounds</u>	<u>GJ per 1,000 kilograms</u>
<b>Energy Category</b>		
Process (1)	15.3	35.5
Transportation	0.34	0.79
Energy of Material Resource	<u>9.86</u>	<u>22.9</u>
<b>Total Energy</b>	<b>25.5</b>	<b>59.2</b>
<b>Energy Category (Percent)</b>		
Process	60%	60%
Transportation	1%	1%
Energy of Material Resource	<u>39%</u>	<u>39%</u>
<b>Total</b>	<b>100%</b>	<b>100%</b>

(1) Process energy includes recovered energy, which is shown as a credit.

Source: Franklin Associates, A Division of ERG

Table 9-2

## Energy Profile for the Production of PVC Resin

	<u>MM Btu per 1,000 pounds</u>	<u>GJ per 1,000 kilograms</u>
<b>Energy Source</b>		
Natural Gas	19.3	44.8
Petroleum	2.57	5.98
Coal	2.53	5.89
Hydropower	0.099	0.23
Nuclear	0.85	1.97
Wood	0	0
Other	0.15	0.36
<b>Recovered Energy (1)</b>	<u>-0.005</u>	<u>-0.013</u>
<b>Total Energy</b>	<b>25.5</b>	<b>59.2</b>
<b>Energy Source (Percent)</b>		
Natural Gas	76%	76%
Petroleum	10%	10%
Coal	10%	10%
Hydropower	0%	0%
Nuclear	3%	3%
Wood	0%	0%
Other	<u>1%</u>	<u>1%</u>
<b>Total</b>	<b>100%</b>	<b>100%</b>

(1) Recovered energy represents the recovery of energy as steam or condensate. Because this energy will be used by other processes, it is shown as a negative entry (credit).

Source: Franklin Associates, A Division of ERG

Both process and fuel-related, as well as total, atmospheric emissions are shown in Table 9-4. As defined in the report glossary, process emissions are those released directly from the sequence of processes that are used to extract, transform, fabricate, or otherwise affect changes on a material or product during its life cycle, while fuel-related emissions are those associated with the combustion of fuels used for process energy and transportation energy.

Table 9-3

## Solid Wastes by Weight for the Production of PVC Resin

	<u>lb per 1,000 pounds</u>	<u>kg per 1,000 kilograms</u>
<b>Solid Wastes By Weight</b>		
Process		
Landfilled	16.5	16.5
Incinerated	5.84	5.84
Waste-to-Energy	21.7	21.7
Fuel	<u>95.4</u>	<u>95.4</u>
<b>Total</b>	<b>139</b>	<b>139</b>
<b>Weight Percent by Category</b>		
Process		
Landfilled	12%	12%
Incinerated	4%	4%
Waste-to-Energy	16%	16%
Fuel	<u>68%</u>	<u>68%</u>
<b>Total</b>	<b>100 %</b>	<b>100 %</b>

Source: Franklin Associates, A Division of ERG

Table 9-5 provides a greenhouse gas (GHG) summary for the production of PVC resin. The primary three atmospheric emissions reported in this analysis that contribute to global warming are fossil fuel-derived carbon dioxide, methane, and nitrous oxide. (Non-fossil carbon dioxide emissions, such as those from the burning of wood, are considered part of the natural carbon cycle and are not considered a net contributor to global warming.) The 100-year global warming potential for each of these substances as reported in the Intergovernmental Panel on Climate Change (IPCC) 2007 report are shown in a note at the bottom of Table 9-5. The global warming potential represents the relative global warming contribution of a pound of a particular greenhouse gas compared to a pound of carbon dioxide. The weights of each of the contributing emissions in Table 9-4 are multiplied by their global warming potential and shown in Table 9-5.

Both process and fuel-related, as well as the total waterborne emissions are shown in Table 9-6. Definitions of process and fuel-related emissions are provided in this chapter, as well as in the glossary.



Table 9-4

**Atmospheric Emissions for the Production of PVC Resin**  
**(lb per 1,000 lb or kg per 1,000 kg)**  
 (page 1 of 2)

	Process emissions	Fuel-related emissions	Total emissions
<b>Atmospheric Emissions</b>			
Carbon Dioxide - Fossil	86.6	2,006	2,092
Methane	2.84	9.70	12.5
Nitrous Oxide	0	0.044	0.044
Carbon Dioxide - Non-Fossil	0	10.1	10.1
Particulates (unspecified)	0.10	0.43	0.53
Particulates (PM10)	0.062	0.21	0.27
Particulates (PM2.5)	0.0033	0.10	0.11
Nitrogen Oxides	0.075	3.19	3.26
Sulfur Dioxide	0.85	4.62	5.47
Sulfur Oxides	0.0023	0.42	0.43
VOC (unspecified)	0.34	0.41	0.75
TNMOC (unspecified)	0.0083	0.016	0.024
Hydrocarbons (unspecified)	0	0.022	0.022
Carbon Monoxide	0.068	1.06	1.13
1,3 Butadiene	0	7.1E-07	7.1E-07
2,4-Dinitrotoluene	0	3.1E-09	3.1E-09
2-Chloroacetophenone	0	7.8E-08	7.8E-08
5-Methyl Chrysene	0	2.8E-09	2.8E-09
Acenaphthene	0	6.6E-08	6.6E-08
Acenaphthylene	0	3.2E-08	3.2E-08
Acetophenone	0	1.7E-07	1.7E-07
acrolein	0	2.5E-04	2.5E-04
Aldehydes (Acetaldehyde)	0	7.3E-05	7.3E-05
Aldehydes (Formaldehyde)	0	0.0013	0.0013
Aldehydes (Propionaldehyde)	0	4.3E-06	4.3E-06
Aldehydes (unspecified)	0	1.1E-04	1.1E-04
Ammonia	3.4E-04	1.3E-04	4.8E-04
Ammonia Chloride	0	8.5E-05	8.5E-05
Anthracene	0	2.7E-08	2.7E-08
Antimony	2.0E-07	2.8E-06	3.0E-06
Arsenic	2.5E-08	5.8E-05	5.8E-05
Benzene	0.042	0.042	0.084
Benzo(a)anthracene	0	1.0E-08	1.0E-08
Benzo(a)pyrene	0	4.9E-09	4.9E-09
Benzo(b,j,k)fluoroanthene	0	1.4E-08	1.4E-08
Benzo(g,h,i) perylene	0	3.5E-09	3.5E-09
Benzyl Chloride	0	7.8E-06	7.8E-06
Beryllium	0	3.3E-06	3.3E-06
Biphenyl	0	2.2E-07	2.2E-07
Bis (2-ethylhexyl) Phthalate (DEHP)	0	8.2E-07	8.2E-07
Bromoform	0	4.4E-07	4.4E-07
Cadmium	0	1.8E-05	1.8E-05
Carbon Disulfide	0	1.5E-06	1.5E-06
Carbon Tetrachloride	1.2E-04	2.4E-06	1.2E-04
CFC 13 (Methane, trichlorofluoro-)	2.1E-06	6.5E-07	2.7E-06
Chlorobenzene	0	2.5E-07	2.5E-07
Chloroform	0	6.6E-07	6.6E-07
Chlorine	0.17	4.1E-05	0.17
Chromium	6.5E-08	4.8E-05	4.8E-05
Chromium (VI)	0	1.0E-05	1.0E-05
Chrysene	0	1.3E-08	1.3E-08
Cobalt	0	2.4E-05	2.4E-05
Copper	0	9.1E-07	9.1E-07
Cumene	0	5.9E-08	5.9E-08
Cyanide	0	2.8E-05	2.8E-05
Dimethyl Sulfate	0	5.4E-07	5.4E-07

Table 9-4

**Atmospheric Emissions for the Production of PVC Resin**  
(lb per 1,000 lb or kg per 1,000 kg)  
(page 2 of 2)

		Process emissions	Fuel-related emissions	Total emissions
Dioxins (unspecified)	(1)	1.1E-10	8.6E-08	8.7E-08
Ethyl Chloride		0	4.7E-07	4.7E-07
Ethylbenzene		0.0050	0.0048	0.0099
Ethylene Dibromide		4.1E-07	1.4E-07	5.5E-07
Ethylene Dichloride		0	4.5E-07	4.5E-07
Fluoranthene		0	9.2E-08	9.2E-08
Fluorene		0	1.2E-07	1.2E-07
Fluorides		0	5.1E-04	5.1E-04
Furans (unspecified)		0	3.0E-10	3.0E-10
Hydrogen Chloride		0.0029	0.15	0.15
Hexane		0	7.5E-07	7.5E-07
Hydrogen Fluoride		0	0.019	0.019
Indeno(1,2,3-cd)pyrene		0	7.9E-09	7.9E-09
Isophorone (C9H14O)		0	6.5E-06	6.5E-06
Kerosene		0	1.5E-04	1.5E-04
Lead		6.8E-09	1.0E-04	1.0E-04
Magnesium		0	0.0014	0.0014
Manganese		0	1.5E-04	1.5E-04
Mercaptan		0	0.0024	0.0024
Mercury		1.6E-05	2.8E-05	4.4E-05
Metals (unspecified)		0	0.0022	0.0022
Methyl Bromide		0	1.8E-06	1.8E-06
Methyl Chloride		0	5.9E-06	5.9E-06
Methyl Ethyl Ketone		0	4.4E-06	4.4E-06
Methyl Hydrazine		0	1.9E-06	1.9E-06
Methyl Methacrylate		0	2.2E-07	2.2E-07
Methyl Tert Butyl Ether (MTBE)		0	3.9E-07	3.9E-07
Methylene Chloride		0	6.6E-05	6.6E-05
Naphthalene		0	1.4E-05	1.4E-05
Nickel		5.5E-07	2.0E-04	2.0E-04
Organics (unspecified)	(2)	0.046	7.2E-04	0.047
Perchloroethylene		0	5.8E-06	5.8E-06
Phenanthrene		0	3.5E-07	3.5E-07
Phenols		0	1.4E-05	1.4E-05
Polyaromatic Hydrocarbons (total)		5.4E-06	7.5E-06	1.3E-05
Propylene		0	4.7E-05	4.7E-05
Pyrene		0	4.3E-08	4.3E-08
Radionuclides (unspecified)	(3)	0	0.0086	0.0086
Selenium		0	1.7E-04	1.7E-04
Styrene		0	2.8E-07	2.8E-07
Toluene		0.065	0.062	0.13
Trichloroethane		0	2.2E-07	2.2E-07
Vinyl Acetate		0	8.5E-08	8.5E-08
Xylenes		0.038	0.036	0.074
Zinc		0	6.0E-07	6.0E-07
HCFC-123		5.6E-05	0	5.6E-05
HCFC-22		0.0010	0	0.0010
HFC-134a		5.6E-05	0	5.6E-05
Hydrogen		0.0018	0	0.0018
NM VOC, non-methane volatile organic compounds, unspecified origin		0.065	0	0.065
Non-Methane Hydrocarbons		0.042	0	0.042
Vinyl Chloride	(4)	0.039	0	0.039

- (1) This emission was provided by the Vinyl Institute based on 2003 Dioxin TRI values and listed EDC capacity for the site assuming an operating rate at EDC capacity. Molar ratios were used to convert to units for PVC. These amounts were calculated as toxic equivalent values (TEQ).
- (2) This emission category contains small amounts of EDC and VCM as well as other hydrocarbons which were not separated out by the data providers. These amounts may be overcounting the VCM emissions as the Vinyl Institute provided atmospheric VCM emissions for the production of EDC/VCM/PVC.
- (3) The units for Radionuclides are Curies per 1,000 lbs of product. The total Radionuclides using metric units are 703,500 kBq per 1,000 kgs of product.
- (4) This vinyl chloride emission was provided by the Vinyl Institute, based on 2003 Vinyl Chloride TRI reported values and 2003 PVC production reported by ACC Resin Statistic Report. This amount includes both the EDC/VCM plant as well as the PVC plant. This value was used to represent a more industry wide average value to account for facilities that did not participate in the LCI inventory. Actual reported figures were lower than the industry average.

Source: Franklin Associates, A Division of ERG

Table 9-5

**Greenhouse Gas Summary for the Production of PVC Resin**  
**(lb carbon dioxide equivalents per 1,000 lb PVC or kg carbon dioxide equivalents per 1,000 kg PVC)**

	<u>Fuel-related CO2 Equiv.</u>	<u>Process CO2 Equiv.</u>	<u>Total CO2 Equiv.</u>
Carbon Dioxide - Fossil	2,006	86.6	2,092
Methane	243	70.9	314
Nitrous Oxide	13.2	0	13.2
Methyl Bromide	9.0E-06	0	9.0E-06
Methyl Chloride	9.5E-05	0	9.5E-05
Trichloroethane	3.1E-05	0	3.1E-05
Chloroform	2.0E-05	0	2.0E-05
Methylene Chloride	6.6E-04	0	6.6E-04
Carbon Tetrachloride	0.0033	0.16	0.17
CFC 13 (Methane, trichlorofluor	0.0076	0.025	0.032
HCFC-123	0	0.0043	0.0043
HCFC-22	0	1.81	1.81
HFC-134a	0	0.080	0.080
Total	<u>2,261</u>	<u>158</u>	<u>2,419</u>

Note: The 100 year global warming potentials used in this table are as follows: fossil carbon dioxide--1, methane--25, nitrous oxide--298, methyl bromide--5, methyl chloride--16, trichloroethane--140, chloroform--30, methylene chloride--10, carbon tetrachloride--1400, CFC-013--11,700, HCFC-22--1810, HCFC-123--77, and HFC-134a--1430.

Source: Franklin Associates, A Division of ERG

Table 9-6

**Waterborne Emissions for the Production of PVC Resin**  
 (lb per 1,000 lb or kg per 1,000 kg)  
 (page 1 of 2)

	Process emissions	Fuel-related emissions	Total emissions
<b>Waterborne Wastes</b>			
1-methylfluorene	9.3E-09	8.5E-09	1.8E-08
2,4 dimethylphenol	3.7E-06	3.2E-06	6.9E-06
2-Hexanone	8.7E-07	7.4E-07	1.6E-06
2-methyl naphthalene	2.1E-06	1.8E-06	3.8E-06
4-methyl-2-pentanone	3.4E-07	3.2E-07	6.6E-07
Acetone	8.2E-07	7.5E-07	1.6E-06
Acid (benzoic)	1.4E-04	1.2E-04	2.5E-04
Acid (hexanoic)	2.8E-05	2.4E-05	5.2E-05
Alkylated Benzenes	2.5E-05	2.1E-05	4.6E-05
Alkylated Fluorenes	1.4E-06	1.2E-06	2.7E-06
Alkylated Naphthalenes	4.1E-07	3.5E-07	7.6E-07
Alkylated Phenanthrenes	1.7E-07	1.4E-07	3.1E-07
Aluminum	0.012	0.011	0.023
Ammonia	0.0038	0.0016	0.0054
Ammonium	0	6.8E-05	6.8E-05
Antimony	7.7E-06	6.5E-06	1.4E-05
Arsenic	2.5E-05	2.3E-05	4.8E-05
Barium	0.17	0.14	0.31
Benzene	1.4E-04	1.2E-04	2.6E-04
Beryllium	1.6E-06	1.3E-06	2.9E-06
BOD	0.20	0.11	0.31
Boron	4.2E-04	3.6E-04	7.7E-04
Bromide	0.016	0.014	0.030
Cadmium	3.9E-06	4.3E-06	8.2E-06
Calcium	0.27	0.23	0.50
Chlorides (methyl chloride)	3.3E-09	3.0E-09	6.3E-09
Chlorides (unspecified)	0	2.83	2.83
Chromium (unspecified)	4.3E-04	2.8E-04	7.0E-04
Cobalt	3.0E-06	2.5E-06	5.5E-06
COD	0.12	0.025	0.14
Copper	3.6E-05	4.8E-05	8.4E-05
Cresols	8.0E-06	6.8E-06	1.5E-05
Cyanide	1.0E-06	5.4E-09	1.0E-06
Cymene	8.1E-09	7.5E-09	1.6E-08
Dibenzofuran	1.5E-08	1.4E-08	3.0E-08
Dibenzothiophene	1.3E-08	1.2E-08	2.4E-08
Dissolved Solids	30.8	2.82	33.6
Ethylbenzene	1.2E-05	6.6E-06	1.9E-05
Fluorine/Fluorides	6.8E-07	0.0011	0.0011
Hardness	0.75	0.63	1.37
Hydrocarbons	0	2.3E-05	2.3E-05
Iron	0.023	0.024	0.047
Lead	6.7E-05	5.9E-05	1.3E-04
Lithium	0.066	0.063	0.13
Magnesium	0.054	0.046	0.10
Manganese	7.7E-05	0.0017	0.0018
Mercury	2.6E-07	1.4E-07	4.0E-07
Methyl Ethyl Ketone (MEK)	6.6E-09	6.0E-09	1.3E-08
Molybdenum	3.1E-06	2.6E-06	5.7E-06
Naphthalene	2.4E-06	2.1E-06	4.5E-06
Nickel	3.1E-05	2.6E-05	5.7E-05
Nitrates	0.010	1.7E-04	0.010
Nitrogen (ammonia)	0	6.0E-05	6.0E-05

Table 9-6

**Waterborne Emissions for the Production of PVC Resin**  
**(lb per 1,000 lb or kg per 1,000 kg)**  
 (page 2 of 2)

	Process emissions	Fuel-related emissions	Total emissions
Oil	0.0044	0.0024	0.0068
Pentamethyl benzene	6.1E-09	5.6E-09	1.2E-08
Phenanthrene	1.1E-07	9.1E-08	2.0E-07
Phenol/Phenolic Compounds	6.1E-04	4.0E-05	6.5E-04
Radionuclides (unspecified) (1)	0	1.2E-07	1.2E-07
Selenium	1.6E-06	2.5E-05	2.7E-05
Silver	1.6E-04	1.4E-04	3.0E-04
Sodium	0.77	0.64	1.42
Strontium	0.0073	0.0062	0.013
Sulfates	0.0055	0.12	0.12
Sulfides	2.2E-05	5.5E-06	2.8E-05
Sulfur	3.4E-04	2.9E-04	6.2E-04
Surfactants	6.6E-05	5.6E-05	1.2E-04
Suspended Solids	1.56	1.17	2.74
Thallium	1.6E-06	1.4E-06	3.0E-06
Tin	3.0E-05	2.6E-05	5.6E-05
Titanium	1.2E-04	1.0E-04	2.2E-04
Toluene	1.7E-04	1.1E-04	2.8E-04
Total Alkalinity	0.0060	0.0050	0.011
Total Biphenyls	1.6E-06	1.4E-06	3.0E-06
Total Dibenzo-thiophenes	5.0E-09	4.2E-09	9.2E-09
Vanadium	8.7E-06	4.6E-06	1.3E-05
Xylenes	6.8E-05	5.6E-05	1.2E-04
Yttrium	9.0E-07	7.6E-07	1.7E-06
Zinc	3.8E-04	2.7E-04	6.5E-04
Dioxins (2)	2.9E-10	0	2.9E-10
Lead 210	1.4E-14	0	1.4E-14
n-Decane	3.9E-06	0	3.9E-06
n-Docosane	8.7E-08	0	8.7E-08
n-Dodecane	7.3E-06	0	7.3E-06
n-Eicosane	2.0E-06	0	2.0E-06
n-Hexacosane	5.4E-08	0	5.4E-08
n-Hexadecane	8.0E-06	0	8.0E-06
n-Octadecane	2.0E-06	0	2.0E-06
Radium 226	4.8E-12	0	4.8E-12
Radium 228	2.5E-14	0	2.5E-14
Styrene	4.5E-07	0	4.5E-07
Tetradecane	3.1E-06	0	3.1E-06
TOC	4.5E-04	0	4.5E-04
Vinyl Chloride (3)	0.0010	0	0.0010

(1) The units for Radionuclides are Curies per 1,000 lbs of product. The total Radionuclides using metric units are 9.84 kBq per 1,000 kgs of product.

(2) This emission was provided by the Vinyl Institute based on 2003 Dioxin TRI values and listed EDC capacity for the site assuming an operating rate at EDC capacity. Molar ratios were used to convert to units for PVC. These amounts were calculated as toxic equivalent values (TEQ).

(3) This vinyl chloride emission was provided by the Vinyl Institute, based on 2003 Vinyl Chloride TRI reported values and 2003 PVC production reported by ACC Resin Statistic Report. This amount includes both the EDC/VCM plant as well as the PVC plant. This value was used to represent a more industry wide average value to account for facilities that did not participate in the LCI inventory. Actual reported figures were lower than the industry average.

Source: Franklin Associates, A Division of ERG

## CHAPTER 10

## CRADLE-TO-RESIN LIFE CYCLE INVENTORY RESULTS FOR ABS RESIN

This chapter presents LCI results for the production of acrylonitrile-butadiene-styrene (ABS) resin (cradle-to-resin). The results are given on the bases of 1,000 pounds and 1,000 kilograms of ABS resin. Figure 10-1 presents the flow diagram for the production of ABS resin. Process descriptions and individual process tables for each box shown in the flow diagram can be found in Appendix J of the Appendices (separate document).

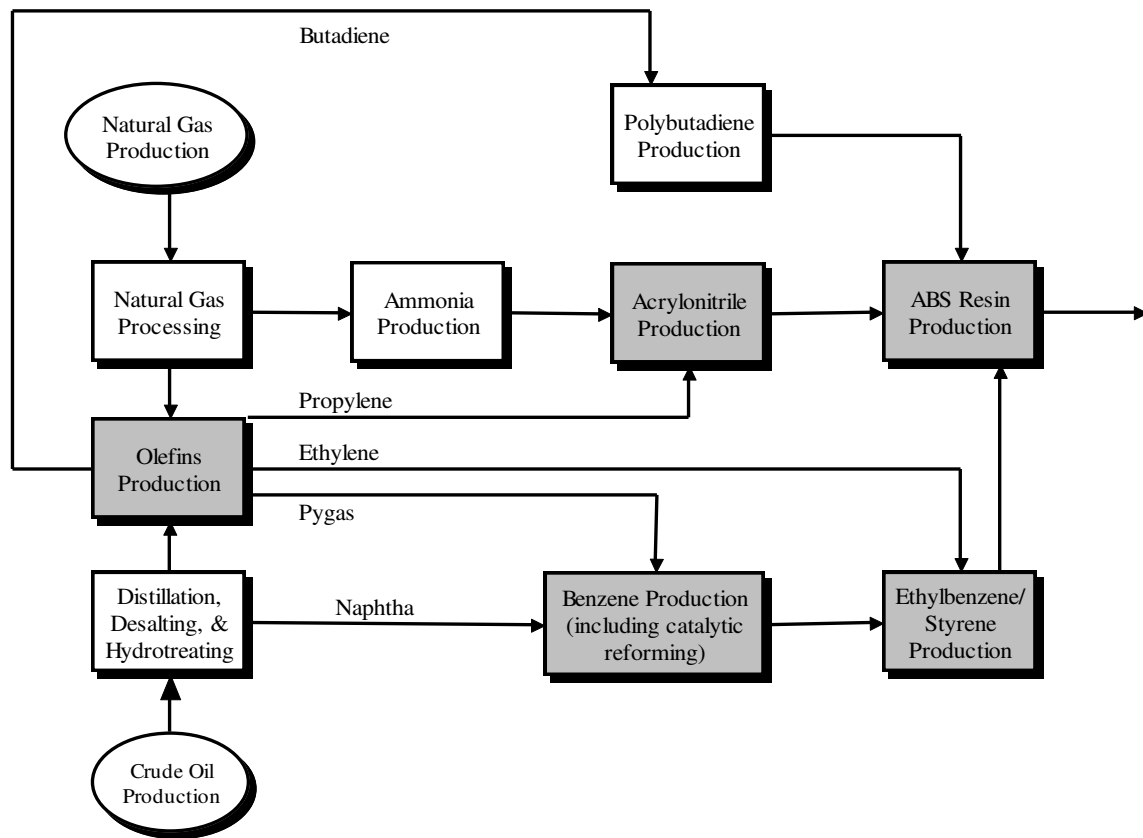

Figure 10-1. Flow diagram for the production of acrylonitrile-butadiene-styrene (ABS) resin. Shaded boxes represent partial or complete data provided by manufacturers specifically for this analysis.

Primary data was collected for olefins, benzene, ethylbenzene/styrene, acrylonitrile, and ABS resin production. A weighted average using production quantities was calculated from the olefins production data collected from three leading producers (8 thermal cracking units) in North America. As of 2003, there were 16 olefin producers and at least 29 olefin plants in the U.S. The captured production amount is approximately 30 percent of the available capacity for olefin production. Numerous coproduct streams are produced from the olefins hydrocracker. Fuel gas and off-gas were two of the coproducts produced that were exported to another process for fuel. When these fuel coproducts are exported from the hydrocracker, they carry with them the allocated share of the inputs and outputs for their production. The separate appendices provide an in-depth discussion of this allocation. A mass basis was used to allocate the credit to the remaining material coproducts.

It is estimated that one-third of the benzene production is from pyrolysis gasoline and two-thirds are produced from catalytic reforming. These percentages were used to weight the collected datasets for benzene. Catalytic reforming is represented by 2 primary datasets from 1992. The benzene data collected for this analysis represent 1 producer and 1 plant in the U.S. using the pyrolysis gasoline production method. As of 2002 there were 22 benzene producers and 38 benzene plants in the U.S. for the three standard technologies. The captured production amount is approximately 10 percent of the available capacity for benzene production in the U.S. Numerous aromatic coproduct streams are produced during this process. Fuel gas and off-gas were two of the coproducts produced that were exported to another process for fuel. When these fuel coproducts are exported from the reactor, they carry with them the allocated share of the inputs and outputs for their production. The separate appendices provide an in-depth discussion of this allocation. A mass basis was used to allocate the credit the remaining aromatic products.

Two of the three ethylbenzene/styrene datasets were collected for this project and represents 2002-2003 data, while the other dataset comes from 1993. As of 2001 there were 8 styrene producers and 8 styrene plants in the U.S. The styrene data collected for this module represent 2 producers and 2 plants in the U.S. The captured production amount is approximately 25 percent of the available capacity for styrene production in the U.S. Various coproduct streams are produced during this process. A mass basis was used to allocate the credit to the coproducts in the datasets collected during this analysis.

Only one company provided the dataset for the production of acrylonitrile. The company provided ranges for the material inputs and coproducts. The median of these ranges was used in the acrylonitrile dataset. The captured production amount is approximately 30 percent of the available capacity for acrylonitrile production in the U.S. Hydrogen cyanide and acetonitrile are produced as coproducts during the production of acrylonitrile. A mass basis was used to allocate the credit for these coproducts.

A weighted average using production amounts was calculated from the ABS production data from five plants collected from three leading producers in North America. As of 2003, there were 4 ABS producers and 7 ABS plants in the U.S. The captured production amount is approximately 50 percent of the 2004 production amount for ABS production in the U.S., Mexico, and Canada. Scrap resin (e.g. off-spec) and heat are produced as coproducts during the production of ABS. A mass basis was used to allocate the credit for scrap, while the energy amount for the heat was reported separately as recovered energy.

## DESCRIPTION OF TABLES

The average gross energy required to produce ABS resin is 45.2 million Btu per 1,000 pounds of resin or 105 GJ per 1,000 kilograms of resin. Tables 10-1 and 10-2 show the breakdown of energy requirements for the production of ABS resin by category and source, respectively. Precombustion energy (the energy used to extract and process fuels used for process energy and transportation energy) is included in the results shown in these tables. Table J-1 in the Appendices (separate document) provides the aggregated unit process energy (cradle-to-resin) for the production of ABS resin. Natural gas and petroleum used as raw material inputs for the production of ABS, reported as energy of material resource in Table 10-1, are included in the totals for natural gas and petroleum energy in Table 10-2. Petroleum-based fuels (e.g. diesel fuel) are the dominant energy source for transportation. Non-fossil sources, such as hydropower, nuclear and other (geothermal, wind, etc.) shown in Table 10-2 are used to generate purchased electricity along with the fossil fuels.

**Table 10-1**

### Energy by Category for the Production of ABS Resin

	<u>MMBtu per 1,000 pounds</u>	<u>GJ per 1,000 kilograms</u>
<b>Energy Category</b>		
Process (1)	21.5	50.1
Transportation	1.09	2.53
Energy of Material Resource	<u>22.6</u>	<u>52.6</u>
<b>Total Energy</b>	<b>45.2</b>	<b>105</b>
<b>Energy Category (Percent)</b>		
Process	48%	48%
Transportation	2%	2%
Energy of Material Resource	<u>50%</u>	<u>50%</u>
<b>Total</b>	<b>100%</b>	<b>100%</b>

(1) Process energy includes recovered energy, which is shown as a credit.

Source: Franklin Associates, A Division of ERG



Table 10-2

## Energy Profile for the Production of ABS Resin

	<u>MM Btu per 1,000 pounds</u>	<u>GJ per 1,000 kilograms</u>
<b>Energy Source</b>		
Natural Gas	25.4	59.2
Petroleum	14.7	34.2
Coal	3.82	8.89
Hydropower	0.13	0.31
Nuclear	1.13	2.63
Wood	0	0
Other	0.21	0.48
<b>Recovered Energy (1)</b>	<u>-0.21</u>	<u>-0.48</u>
<b>Total Energy</b>	<b>45.2</b>	<b>105</b>
<b>Energy Source (Percent)</b>		
Natural Gas	56%	56%
Petroleum	32%	32%
Coal	8%	8%
Hydropower	0%	0%
Nuclear	2%	2%
Wood	0%	0%
Other	<u>0%</u>	<u>0%</u>
<b>Total</b>	<b>100%</b>	<b>100%</b>

(1) Recovered energy represents the recovery of energy as steam or condensate. Because this energy will be used by other processes, it is shown as a negative entry (credit).

Source: Franklin Associates, A Division of ERG

Table 10-3 shows the weight of solid waste generated during the production of ABS resin. The process solid waste, those wastes produced directly from the cradle-to-resin processes, includes wastes that are incinerated both for disposal and for waste-to-energy, as well as landfilled. These categories have been provided separately. Solid waste from fuel production and combustion is also presented.

Both process and fuel-related, as well as total, atmospheric emissions are shown in Table 10-4. As defined in the report glossary, process emissions are those released directly from the sequence of processes that are used to extract, transform, fabricate, or otherwise affect changes on a material or product during its life cycle, while fuel-related emissions are those associated with the combustion of fuels used for process energy and transportation energy.

Table 10-3

## Solid Wastes by Weight for the Production of ABS Resin

	<u>lb per 1,000 pounds</u>	<u>kg per 1,000 kilograms</u>
<b>Solid Wastes By Weight</b>		
Process		
Landfilled	52.4	52.4
Incinerated	7.29	7.29
Waste-to-Energy	0.81	0.81
Fuel	<u>139</u>	<u>139</u>
<b>Total</b>	<b>200</b>	<b>200</b>
<b>Weight Percent by Category</b>		
Process		
Landfilled	26%	26%
Incinerated	4%	4%
Waste-to-Energy	0%	0%
Fuel	<u>70%</u>	<u>70%</u>
<b>Total</b>	<b>100 %</b>	<b>100 %</b>

Source: Franklin Associates, A Division of ERG

Table 10-5 provides a greenhouse gas (GHG) summary for the production of ABS resin. The primary three atmospheric emissions reported in this analysis that contribute to global warming are fossil fuel-derived carbon dioxide, methane, and nitrous oxide. (Non-fossil carbon dioxide emissions, such as those from the burning of wood, are considered part of the natural carbon cycle and are not considered a net contributor to global warming.) The 100-year global warming potential for each of these substances as reported in the Intergovernmental Panel on Climate Change (IPCC) 2007 report are shown in a note at the bottom of Table 10-5. The global warming potential represents the relative global warming contribution of a pound of a particular greenhouse gas compared to a pound of carbon dioxide. The weights of each of the contributing emissions in Table 10-4 are multiplied by their global warming potential and shown in Table 10-5.

Both process and fuel-related, as well as the total waterborne emissions are shown in Table 10-6. Definitions of process and fuel-related emissions are provided in this chapter, as well as in the glossary.

Table 10-4

**Atmospheric Emissions for the Production of ABS Resin**  
(lb per 1,000 lb or kg per 1,000 kg)  
(page 1 of 2)

	Process emissions	Fuel-related emissions	Total emissions
<b>Atmospheric Emissions</b>			
Carbon Dioxide - Fossil	253	3,034	3,287
Methane	6.82	13.0	19.8
Nitrous Oxide	0	0.073	0.073
Carbon Dioxide - Non-Fossil	0	13.4	13.4
Particulates (unspecified)	0.16	0.64	0.80
Particulates (PM10)	0.094	0.47	0.56
Particulates (PM2.5)	0.020	0.21	0.23
Nitrogen Oxides	0.96	6.55	7.51
Sulfur Dioxide	1.35	6.73	8.07
Sulfur Oxides	0.24	1.75	1.99
VOC (unspecified)	0.49	0.57	1.06
TNMOC (unspecified)	0	0.027	0.027
Hydrocarbons (unspecified)	0	0.067	0.067
Carbon Monoxide	0.88	1.79	2.67
1,3 Butadiene	0	1.2E-06	1.2E-06
2,4-Dinitrotoluene	0	9.6E-09	9.6E-09
2-Chloroacetophenone	0	2.4E-07	2.4E-07
5-Methyl Chrysene	0	4.2E-09	4.2E-09
Acenaphthene	0	9.8E-08	9.8E-08
Acenaphthylene	0	4.8E-08	4.8E-08
Acetophenone	0	5.1E-07	5.1E-07
acrolein	0	3.3E-04	3.3E-04
Aldehydes (Acetaldehyde)	0	1.1E-04	1.1E-04
Aldehydes (Formaldehyde)	0	0.0019	0.0019
Aldehydes (Propionaldehyde)	0	1.3E-05	1.3E-05
Aldehydes (unspecified)	0	1.5E-04	1.5E-04
Ammonia	0.10	3.7E-04	0.10
Ammonia Chloride	0	1.1E-04	1.1E-04
Anthracene	0	4.0E-08	4.0E-08
Antimony	1.3E-06	4.2E-06	5.5E-06
Arsenic	1.7E-07	8.8E-05	8.8E-05
Benzene	0.061	0.053	0.11
Benzo(a)anthracene	0	1.5E-08	1.5E-08
Benzo(a)pyrene	0	7.3E-09	7.3E-09
Benzo(b,j,k)fluoranthene	0	2.1E-08	2.1E-08
Benzo(g,h,i) perylene	0	5.2E-09	5.2E-09
Benzyl Chloride	0	2.4E-05	2.4E-05
Beryllium	0	4.6E-06	4.6E-06
Biphenyl	0	3.3E-07	3.3E-07
Bis(2-ethylhexyl) Phthalate (DEHP)	0	2.5E-06	2.5E-06
Bromoform	0	1.3E-06	1.3E-06
Cadmium	0	2.6E-05	2.6E-05
Carbon Disulfide	0	4.5E-06	4.5E-06
Carbon Tetrachloride	8.8E-07	3.2E-06	4.1E-06
CFC 13 (Methane, trichlorofluoro-)	1.4E-05	2.1E-06	1.6E-05
Chlorobenzene	0	7.5E-07	7.5E-07
Chloroform	0	2.0E-06	2.0E-06
Chlorine	1.1E-04	5.4E-05	1.7E-04
Chromium	4.4E-07	7.0E-05	7.0E-05
Chromium (VI)	0	1.5E-05	1.5E-05
Chrysene	0	1.9E-08	1.9E-08
Cobalt	0	5.7E-05	5.7E-05

Table 10-4

**Atmospheric Emissions for the Production of ABS Resin**  
(lb per 1,000 lb or kg per 1,000 kg)  
(page 2 of 2)

	Process emissions	Fuel-related emissions	Total emissions
Copper	0	7.4E-07	7.4E-07
Cumene	0	1.8E-07	1.8E-07
Cyanide	0	8.6E-05	8.6E-05
Dimethyl Sulfate	0	1.6E-06	1.6E-06
Dioxins (unspecified)	0	1.2E-07	1.2E-07
Ethyl Chloride	0	1.4E-06	1.4E-06
Ethylbenzene	0.0072	0.0058	0.013
Ethylene Dibromide	2.7E-06	4.5E-07	3.2E-06
Ethylene Dichloride	0	1.4E-06	1.4E-06
Fluoranthene	0	1.4E-07	1.4E-07
Fluorene	0	1.7E-07	1.7E-07
Fluorides	0	0.0015	0.0015
Furans (unspecified)	0	4.0E-10	4.0E-10
Hydrogen Chloride	5.9E-07	0.22	0.22
Hexane	0	2.3E-06	2.3E-06
Hydrogen Fluoride	0	0.027	0.027
Indeno(1,2,3-cd)pyrene	0	1.2E-08	1.2E-08
Isophorone (C9H14O)	0	2.0E-05	2.0E-05
Kerosene	0	2.0E-04	2.0E-04
Lead	0	2.1E-04	2.1E-04
Magnesium	0	0.0021	0.0021
Manganese	0	2.2E-04	2.2E-04
Mercaptan	0	0.0074	0.0074
Mercury	0	6.2E-05	6.2E-05
Metals (unspecified)	0	0.0029	0.0029
Methyl Bromide	0	5.5E-06	5.5E-06
Methyl Chloride	0	1.8E-05	1.8E-05
Methyl Ethyl Ketone	0	1.3E-05	1.3E-05
Methyl Hydrazine	0	5.8E-06	5.8E-06
Methyl Methacrylate	0	6.9E-07	6.9E-07
Methyl Tert Butyl Ether (MTBE)	0	1.2E-06	1.2E-06
Methylene Chloride	0	1.1E-04	1.1E-04
Naphthalene	0	2.3E-05	2.3E-05
Nickel	3.7E-06	6.0E-04	6.0E-04
Organics (unspecified)	0.14	9.6E-04	0.14
Perchloroethylene	0	8.8E-06	8.8E-06
Phenanthrene	0	5.2E-07	5.2E-07
Phenols	0	3.2E-05	3.2E-05
Polyaromatic Hydrocarbons (total)	3.6E-05	1.5E-05	5.0E-05
Propylene	0	7.8E-05	7.8E-05
Pyrene	0	6.3E-08	6.3E-08
Radionuclides (unspecified) (1)	0	0.012	0.012
Selenium	0	2.6E-04	2.6E-04
Styrene	0	8.6E-07	8.6E-07
Toluene	0.093	0.075	0.17
Trichloroethane	0	6.9E-07	6.9E-07
Vinyl Acetate	0	2.6E-07	2.6E-07
Xylenes	0.054	0.044	0.098
Zinc	0	5.0E-07	5.0E-07
HCFC-22	1.0E-04	0	1.0E-04
Hydrogen	0.0029	0	0.0029
Hydrogen Cyanide	0.010	0	0.010
NM VOC, non-methane volatile organic compounds, unspecified origin	0.44	0	0.44
Non-Methane Hydrocarbons	2.15	0	2.15

(1) The units for Radionuclides are Curies per 1,000 lbs of product. The total Radionuclides using metric units are 940,500 kBq per 1,000 kgs of product.

Source: Franklin Associates, A Division of ERG

Table 10-5

**Greenhouse Gas Summary for the Production of ABS Resin**  
**(lb carbon dioxide equivalents per 1,000 lb ABS or kg carbon dioxide equivalents per 1,000 kg ABS)**

	<u>Fuel-related CO2 Equiv.</u>	<u>Process CO2 Equiv.</u>	<u>Total CO2 Equiv.</u>
Carbon Dioxide - Fossil	3,034	253	3,287
Methane	326	170	496
Nitrous Oxide	21.8	0	21.8
Methyl Bromide	2.7E-05	0	2.7E-05
Methyl Chloride	2.9E-04	0	2.9E-04
Trichloroethane	9.6E-05	0	9.6E-05
Chloroform	6.1E-05	0	6.1E-05
Methylene Chloride	0.0011	0	0.0011
Carbon Tetrachloride	0.0045	0.0012	0.0058
CFC 13 (Methane, trichlorofluor	0.024	0.16	0.19
HCFC-22	0	0.18	0.18
Total	<u>3,381</u>	<u>424</u>	<u>3,805</u>

Note: The 100 year global warming potentials used in this table are as follows: fossil carbon dioxide--1, methane--25, nitrous oxide--298, methyl bromide--5, methyl chloride--16, trichloroethane--140, chloroform--30, methylene chloride--10, carbon tetrachloride--1400, CFC-013--11,700, HCFC-22--1810, HCFC-123--77, and HFC-134a--1430.

Source: Franklin Associates, A Division of ERG

Table 10-6

**Waterborne Emissions for the Production of ABS Resin**  
**(lb per 1,000 lb or kg per 1,000 kg)**  
 (page 1 of 2)

	Process emissions	Fuel-related emissions	Total emissions
<b>Waterborne Wastes</b>			
1-methylfluorene	1.6E-08	1.1E-08	2.7E-08
2,4 dimethylphenol	8.6E-06	4.2E-06	1.3E-05
2-Hexanone	2.0E-06	9.8E-07	3.0E-06
2-methyl naphthalene	4.7E-06	2.3E-06	7.0E-06
4-methyl-2-pentanone	5.9E-07	3.9E-07	9.8E-07
Acetone	1.4E-06	9.3E-07	2.3E-06
Acid (benzoic)	3.1E-04	1.5E-04	4.6E-04
Acid (hexanoic)	6.4E-05	3.2E-05	9.6E-05
Alkylated Benzenes	5.8E-05	2.8E-05	8.6E-05
Alkylated Fluorenes	3.4E-06	1.6E-06	5.0E-06
Alkylated Naphthalenes	9.5E-07	4.6E-07	1.4E-06
Alkylated Phenanthrenes	3.9E-07	1.9E-07	5.8E-07
Aluminum	0.028	0.015	0.043
Ammonia	0.12	0.0030	0.12
Ammonium	0	9.1E-05	9.1E-05
Antimony	1.8E-05	8.6E-06	2.6E-05
Arsenic	6.0E-05	3.1E-05	9.1E-05
Barium	0.38	0.19	0.57
Benzene	3.4E-04	1.6E-04	5.0E-04
Beryllium	3.8E-06	1.8E-06	5.6E-06
BOD	0.37	0.15	0.53
Boron	9.6E-04	4.7E-04	0.0014
Bromide	0.039	0.018	0.057
Cadmium	9.3E-06	5.8E-06	1.5E-05
Calcium	0.65	0.30	0.95
Chlorides (methyl chloride)	5.6E-09	3.8E-09	9.4E-09
Chlorides (unspecified)	0	3.79	3.79
Chromium (unspecified)	7.6E-04	3.7E-04	0.0011
Cobalt	6.8E-06	3.3E-06	1.0E-05
COD	3.83	0.047	3.88
Copper	8.3E-05	6.5E-05	1.5E-04
Cresols	1.8E-05	9.0E-06	2.7E-05
Cyanide	1.0E-08	6.7E-09	1.7E-08
Cymene	1.4E-08	9.3E-09	2.3E-08
Dibenzofuran	2.7E-08	1.8E-08	4.4E-08
Dibenzothiophene	2.2E-08	1.4E-08	3.6E-08
Dissolved Solids	9.22	3.79	13.0
Ethylbenzene	7.0E-04	8.8E-06	7.1E-04
Fluorine/Fluorides	1.6E-06	0.0015	0.0015
Hardness	1.81	0.84	2.66
Hydrocarbons	0	3.0E-05	3.0E-05
Iron	0.053	0.033	0.086
Lead	1.6E-04	7.9E-05	2.4E-04
Lithium	0.095	0.076	0.17
Magnesium	0.13	0.061	0.19
Manganese	1.9E-04	0.0025	0.0027
Mercury	3.5E-07	1.9E-07	5.4E-07
Metal (unspecified)	1.0E-04	0	1.0E-04
Methyl Ethyl Ketone (MEK)	1.1E-08	7.5E-09	1.9E-08
Molybdenum	7.0E-06	3.5E-06	1.0E-05

Table 10-6

**Waterborne Emissions for the Production of ABS Resin**  
**(lb per 1,000 lb or kg per 1,000 kg)**  
 (page 2 of 2)

	Process emissions	Fuel-related emissions	Total emissions
Naphthalene	5.5E-06	2.7E-06	8.3E-06
Nickel	7.2E-05	3.5E-05	1.1E-04
Nitrates	0.010	2.3E-04	0.010
Nitrogen (ammonia)	0	8.0E-05	8.0E-05
Oil	0.14	0.0038	0.14
Pentamethyl benzene	1.1E-08	7.0E-09	1.8E-08
Phenanthrene	2.4E-07	1.2E-07	3.6E-07
Phenol/Phenolic Compounds	9.7E-04	6.6E-05	0.0010
Radionuclides (unspecified) (1)	0	1.6E-07	1.6E-07
Selenium	4.5E-06	3.4E-05	3.8E-05
Silver	3.9E-04	1.8E-04	5.8E-04
Sodium	1.87	0.87	2.73
Strontium	0.017	0.0082	0.025
Sulfates	0.013	0.15	0.17
Sulfides	6.5E-04	1.8E-05	6.6E-04
Sulfur	7.5E-04	3.8E-04	0.0011
Surfactants	1.6E-04	7.5E-05	2.3E-04
Suspended Solids	4.33	1.57	5.89
Thallium	3.7E-06	1.8E-06	5.6E-06
Tin	7.0E-05	3.4E-05	1.0E-04
Titanium	2.7E-04	1.3E-04	4.1E-04
Toluene	3.8E-04	1.5E-04	5.3E-04
Total Alkalinity	0.014	0.0067	0.021
Total Biphenyls	3.7E-06	1.8E-06	5.6E-06
Total Dibenzo-thiophenes	1.2E-08	5.6E-09	1.7E-08
Vanadium	4.3E-05	9.1E-06	5.2E-05
Xylenes	1.6E-04	7.6E-05	2.4E-04
Yttrium	2.0E-06	1.0E-06	3.1E-06
Zinc	7.4E-04	3.6E-04	0.0011
Lead 210	3.2E-14	0	3.2E-14
n-Decane	8.8E-06	0	8.8E-06
n-Docosane	1.5E-07	0	1.5E-07
n-Dodecane	1.7E-05	0	1.7E-05
n-Eicosane	4.6E-06	0	4.6E-06
n-Hexacosane	9.4E-08	0	9.4E-08
n-Hexadecane	1.8E-05	0	1.8E-05
n-Octadecane	4.6E-06	0	4.6E-06
Other Organics	1.0E-04	0	1.0E-04
Phosphates	0.010	0	0.010
Radium 226	1.1E-11	0	1.1E-11
Radium 228	5.6E-14	0	5.6E-14
Styrene	6.7E-04	0	6.7E-04
Tetradecane	7.1E-06	0	7.1E-06
TOC	7.4E-04	0	7.4E-04

(1) The units for Radionuclides are Curies per 1,000 lbs of product. The total Radionuclides using metric units are 13.16 kBq per 1,000 kgs of product.

Source: Franklin Associates, A Division of ERG

## CHAPTER 11

CRADLE-TO-PRECURSOR LIFE CYCLE INVENTORY RESULTS FOR  
POLYETHER POLYOL USED FOR RIGID FOAM POLYURETHANE

This chapter presents LCI results for the production of polyether polyol used for rigid foam polyurethane (cradle-to-polyol). The results are given on the bases of 1,000 pounds and 1,000 kilograms of the polyol. Figure 11-1 presents the flow diagram for the production of the polyol. Process descriptions and individual process tables for each box shown in the flow diagram can be found in Appendix K of the Appendices (separate document).

Primary data was collected for olefins, chlorine/caustic soda, and polyether polyol production. A weighted average using production quantities was calculated from the olefins production data collected from three leading producers (8 thermal cracking units) in North America. As of 2003, there were 16 olefin producers and at least 29 olefin plants in the U.S. The captured production amount is approximately 30 percent of the available capacity for olefin production. Numerous coproduct streams are produced from the olefins hydrocracker. Fuel gas and off-gas were two of the coproducts produced that were exported to another process for fuel. When these fuel coproducts are exported from the hydrocracker, they carry with them the allocated share of the inputs and outputs for their production. The separate appendices provide an in-depth discussion of this allocation. A mass basis was used to allocate the credit to the remaining material coproducts.

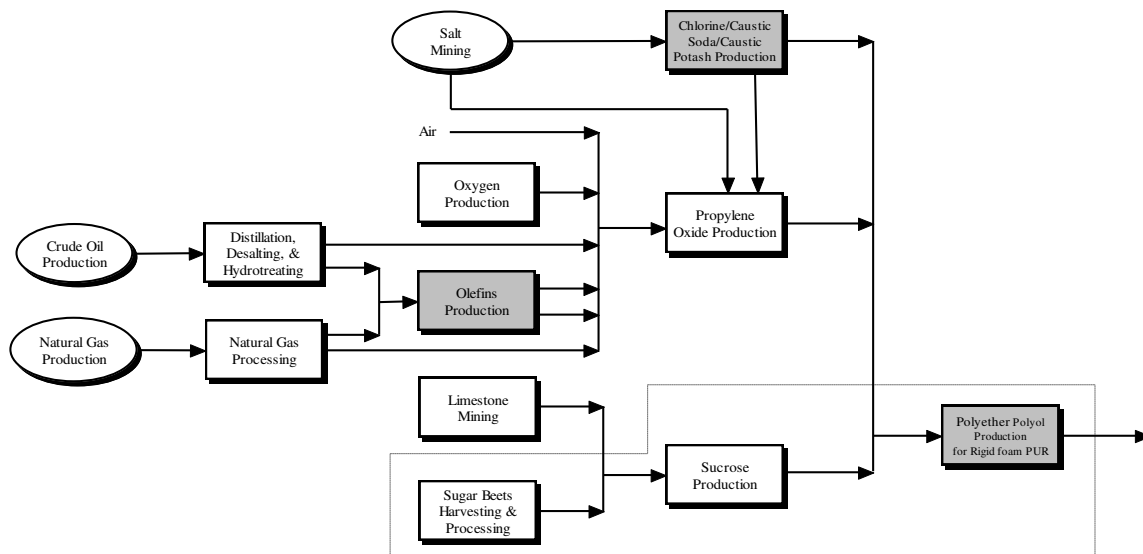

Figure 11-1. Flow diagram for the manufacture of polyether polyol for rigid foam polyurethane. Shaded boxes represent partial or complete data provided by manufacturers specifically for this APC analysis. Boxes within the dotted lines are included in an aggregated dataset. Polyol types vary greatly by use. Additives are not included in this analysis of polyether polyols.



The chlorine/caustic data collected for this module represent 1 producer and 3 plants in the U.S. Besides this recently collected data, 2 diaphragm cell datasets and 2 mercury cell datasets were used from the early 1990s. The mercury cell technology is more likely to be used to produce high-purity caustic, than chlorine to be used in EDC; however, a small percentage of chlorine used in EDC does still come from mercury cells. For this analysis, it is estimated that 91.4 percent of the cell technology is diaphragm and membrane, while 8.6 percent of the cell technology is mercury. The collected datasets were weighted using these fractions. As of 2003 there were 20 chlorine/caustic producers and 41 chlorine/caustic plants in the U.S. for the three standard technologies. The captured production amount is approximately 30 percent of the available capacity for all chlorine production in the U.S. Caustic soda and hydrogen are the coproducts produced with chlorine. A mass basis was used to allocate the credit to the coproducts.

A weighted average using production amounts was calculated from the polyol production data from two plants collected from two leading producers in North America. As of 2002, it is estimated that for all polyurethane applications, there were 7 polyether polyol producers and 9 polyether polyol plants in the U.S. The captured production amount is approximately 40 percent of the available capacity for polyol production in the U.S. and Canada. Heat was a coproduct for one producer. The energy for exported heat was reported separately as recovered energy.

## DESCRIPTION OF TABLES

The average gross energy required to produce the polyether polyol for rigid foam polyurethane is 35.7 million Btu per 1,000 pounds or 83.1 GJ per 1,000 kilograms. Tables 11-1 and 11-2 show the breakdown of energy requirements for the production of polyol by category and source, respectively. Precombustion energy (the energy used to extract and process fuels used for process energy and transportation energy) is included in the results shown in these tables. Table K-1 in the Appendices (separate document) provides the aggregated unit process energy (cradle-to-polyol) for the production of the polyol. Natural gas and petroleum used as raw material inputs for the production of the polyol, reported as energy of material resource in Table 11-1, are included in the totals for natural gas and petroleum energy in Table 11-2. Petroleum-based fuels (e.g. diesel fuel) are the dominant energy source for transportation. Non-fossil sources, such as hydropower, nuclear and other (geothermal, wind, etc.) shown in Table 11-2 are used to generate purchased electricity along with the fossil fuels.

Table 11-1

Energy by Category for the Production of Polyether Polyol  
for Rigid Foam Polyurethane

	<u>MMBtu per 1,000 pounds</u>	<u>GJ per 1,000 kilograms</u>
<b>Energy Category</b>		
Process (1)	22.9	53.3
Transportation	0.66	1.52
Energy of Material Resource	<u>12.1</u>	<u>28.2</u>
<b>Total Energy</b>	<b>35.7</b>	<b>83.1</b>
<b>Energy Category (Percent)</b>		
Process	64%	64%
Transportation	2%	2%
Energy of Material Resource	<u>34%</u>	<u>34%</u>
<b>Total</b>	<b>100%</b>	<b>100%</b>

---

(1) Process energy includes recovered energy, which is shown as a credit.

Source: Franklin Associates, A Division of ERG

Table 11-2

Energy Profile for the Production of Polyether Polyol  
for Rigid Foam Polyurethane

	<u>MM Btu per 1,000 pounds</u>	<u>GJ per 1,000 kilograms</u>
<b>Energy Source</b>		
Natural Gas	20.8	48.4
Petroleum	9.07	21.1
Coal	4.35	10.13
Hydropower	0.14	0.33
Nuclear	1.21	2.81
Wood	0	0
Other	0.22	0.51
<b>Recovered Energy (1)</b>	<u>-0.10</u>	<u>-0.23</u>
<b>Total Energy</b>	<b>35.7</b>	<b>83.1</b>
<b>Energy Source (Percent)</b>		
Natural Gas	58%	58%
Petroleum	25%	25%
Coal	12%	12%
Hydropower	0%	0%
Nuclear	3%	3%
Wood	0%	0%
Other	<u>1%</u>	<u>1%</u>
<b>Total</b>	<b>100%</b>	<b>100%</b>

(1) Recovered energy represents the recovery of energy as steam or condensate. Because this energy will be used by other processes, it is shown as a negative entry (credit).

Source: Franklin Associates, A Division of ERG

Table 11-3 shows the weight of solid waste generated during the production of polyether polyol for rigid foam polyurethane. The process solid waste, those wastes produced directly from the cradle-to-precursor processes, includes wastes that are incinerated both for disposal and for waste-to-energy, as well as landfilled. These categories have been provided separately. Solid waste from fuel production and combustion is also presented.

Both process and fuel-related, as well as total, atmospheric emissions are shown in Table 11-4. As defined in the report glossary, process emissions are those released directly from the sequence of processes that are used to extract, transform, fabricate, or otherwise affect changes on a material or product during its life cycle, while fuel-related emissions are those associated with the combustion of fuels used for process energy and transportation energy.

Table 11-3

**Solid Wastes by Weight for the Production of Polyether Polyol  
for Rigid Foam Polyurethane**

	<u>lb per 1,000 pounds</u>	<u>kg per 1,000 kilograms</u>
<b>Solid Wastes By Weight</b>		
Process		
Landfilled	21.3	21.3
Incinerated	4.57	4.57
Waste-to-Energy	0.0026	0.0026
Fuel	158	158
<b>Total</b>	<b>184</b>	<b>184</b>
<b>Weight Percent by Category</b>		
Process		
Landfilled	12%	12%
Incinerated	2%	2%
Waste-to-Energy	0%	0%
Fuel	86%	86%
<b>Total</b>	<b>100%</b>	<b>100%</b>

Source: Franklin Associates, A Division of ERG

Table 11-4

**Atmospheric Emissions for the Production of Polyether Polyol for Rigid Foam Polyurethane**  
(lb per 1,000 lb or kg per 1,000 kg)  
(page 1 of 2)

	Process emissions	Fuel-related emissions	Total emissions
<b>Atmospheric Emissions</b>			
Carbon Dioxide - Fossil	58.3	3,237	3,295
Methane	3.72	12.1	15.9
Nitrous Oxide	0	0.086	0.086
Carbon Dioxide - Non-Fossil	0	14.4	14.4
Particulates (unspecified)	0.26	0.72	0.98
Particulates (PM10)	0.12	0.70	0.82
Particulates (PM2.5)	0.016	0.33	0.35
Nitrogen Oxides	0.53	6.44	6.97
Sulfur Dioxide	0.91	7.49	8.41
Sulfur Oxides	0.0039	1.80	1.81
VOC (unspecified)	0.35	0.62	0.97
TNMOC (unspecified)	0	0.032	0.032
Hydrocarbons (unspecified)	0	0.14	0.14
Carbon Monoxide	0.24	2.29	2.52
1,3 Butadiene	0	1.6E-05	1.6E-05
2,4-Dinitrotoluene	0	1.4E-08	1.4E-08
2-Chloroacetophenone	0	3.4E-07	3.4E-07
5-Methyl Chrysene	0	4.8E-09	4.8E-09
Acenaphthene	0	1.1E-07	1.1E-07
Acenaphthylene	0	5.4E-08	5.4E-08
Acetophenone	0	7.3E-07	7.3E-07
acrolein	0	3.9E-04	3.9E-04
Aldehydes (Acetaldehyde)	0	4.1E-04	4.1E-04
Aldehydes (Formaldehyde)	0	0.0027	0.0027
Aldehydes (Propionaldehyde)	0	1.8E-05	1.8E-05
Aldehydes (unspecified)	0	1.6E-04	1.6E-04
Ammonia	0.038	7.4E-04	0.039
Ammonia Chloride	0	1.2E-04	1.2E-04
Anthracene	0	4.6E-08	4.6E-08
Antimony	5.1E-07	4.9E-06	5.4E-06
Arsenic	6.4E-08	1.1E-04	1.1E-04
Benzene	0.043	0.052	0.095
Benzo(a)anthracene	0	1.7E-08	1.7E-08
Benzo(a)pyrene	0	8.2E-09	8.2E-09
Benzo(b,j,k)fluoroanthene	0	2.4E-08	2.4E-08
Benzo(g,h,i) perylene	0	5.9E-09	5.9E-09
Benzyl Chloride	0	3.4E-05	3.4E-05
Beryllium	0	6.7E-06	6.7E-06
Biphenyl	0	3.7E-07	3.7E-07
Bis(2-ethylhexyl) Phthalate (DEHP)	0	3.5E-06	3.5E-06
Bromoform	0	1.9E-06	1.9E-06
Cadmium	0	3.2E-05	3.2E-05
Carbon Disulfide	0	6.3E-06	6.3E-06
Carbon Tetrachloride	1.8E-04	3.6E-06	1.8E-04
CFC 13 (Methane, trichlorofluoro-)	5.4E-06	4.3E-06	9.7E-06
Chlorobenzene	0	1.1E-06	1.1E-06
Chloroform	0	2.9E-06	2.9E-06
Chlorine	0.0022	5.8E-05	0.0023
Chromium	1.7E-07	8.4E-05	8.4E-05
Chromium (VI)	0	1.7E-05	1.7E-05
Chrysene	0	2.2E-08	2.2E-08
Cobalt	0	1.1E-04	1.1E-04

Table 11-4  
 Atmospheric Emissions for the Production of Polyether Polyol for Rigid Foam Polyurethane  
 (lb per 1,000 lb or kg per 1,000 kg)  
 (page 2 of 2)

	Process emissions	Fuel-related emissions	Total emissions
Copper	0	3.6E-06	3.6E-06
Cumene	0	2.6E-07	2.6E-07
Cyanide	0	1.2E-04	1.2E-04
Dimethyl Sulfate	0	2.3E-06	2.3E-06
Dioxins (unspecified)	0	1.2E-07	1.2E-07
Ethyl Chloride	0	2.0E-06	2.0E-06
Ethylbenzene	0.73	0.0055	0.74
Ethylene Dibromide	1.1E-06	9.0E-07	2.0E-06
Ethylene Dichloride	0	1.9E-06	1.9E-06
Fluoranthene	0	1.5E-07	1.5E-07
Fluorene	0	2.0E-07	2.0E-07
Fluorides	0	0.0022	0.0022
Furans (unspecified)	0	4.2E-10	4.2E-10
Hydrogen Chloride	2.9E-04	0.25	0.25
Hexane	0	3.3E-06	3.3E-06
Hydrogen Fluoride	0	0.030	0.030
Indeno(1,2,3-cd)pyrene	0	1.3E-08	1.3E-08
Isophorone (C9H14O)	0	2.8E-05	2.8E-05
Kerosene	0	2.2E-04	2.2E-04
Lead	9.7E-09	2.8E-04	2.8E-04
Magnesium	0	0.0024	0.0024
Manganese	0	2.7E-04	2.7E-04
Mercaptan	0	0.011	0.011
Mercury	1.6E-04	8.4E-05	2.4E-04
Metals (unspecified)	0	0.0031	0.0031
Methyl Bromide	0	7.8E-06	7.8E-06
Methyl Chloride	0	2.6E-05	2.6E-05
Methyl Ethyl Ketone	0	1.9E-05	1.9E-05
Methyl Hydrazine	0	8.3E-06	8.3E-06
Methyl Methacrylate	0	9.7E-07	9.7E-07
Methyl Tert Butyl Ether (MTBE)	0	1.7E-06	1.7E-06
Methylene Chloride	0	1.8E-04	1.8E-04
Naphthalene	0	3.4E-05	3.4E-05
Nickel	1.4E-06	0.0014	0.0014
Organics (unspecified)	0.11	0.0010	0.11
Perchloroethylene	0	1.1E-05	1.1E-05
Phenanthrene	0	5.9E-07	5.9E-07
Phenols	0	7.7E-05	7.7E-05
Polyaromatic Hydrocarbons (total)	1.4E-05	8.4E-05	9.7E-05
Propylene	0	0.0010	0.0010
Propylene Oxide	0.36	0	0.36
Pyrene	0	7.2E-08	7.2E-08
Radionuclides (unspecified) (1)	0	0.012	0.012
Selenium	0	3.0E-04	3.0E-04
Styrene	0	1.2E-06	1.2E-06
Toluene	0.067	0.072	0.14
Trichloroethane	0	9.7E-07	9.7E-07
Vinyl Acetate	0	3.7E-07	3.7E-07
Xylenes	0.039	0.042	0.081
Zinc	0	2.4E-06	2.4E-06
Acid (unknown)	0.033	0	0.033
HCFC-123	8.3E-05	0	8.3E-05
HCFC-22	5.9E-07	0	5.9E-07
HFC-134a	8.3E-05	0	8.3E-05
Hydrogen	0.0030	0	0.0030
NMVOC, non-methane volatile organic compounds, unspecified origin	0.17	0	0.17
Non-Methane Hydrocarbons	4.49	0	4.49

(1) The units for Radionuclides are Curies per 1,000 lbs of product. The total Radionuclides using metric units are 1,005,000 kBq per 1,000 kgs of product.

Source: Franklin Associates, A Division of ERG

Table 11-5 provides a greenhouse gas (GHG) summary for the production of polyether polyol for rigid foam polyurethane. The primary three atmospheric emissions reported in this analysis that contribute to global warming are fossil fuel-derived carbon dioxide, methane, and nitrous oxide. (Non-fossil carbon dioxide emissions, such as those from the burning of wood, are considered part of the natural carbon cycle and are not considered a net contributor to global warming.) The 100-year global warming potential for each of these substances as reported in the Intergovernmental Panel on Climate Change (IPCC) 2007 report are shown in a note at the bottom of Table 11-5. The global warming potential represents the relative global warming contribution of a pound of a particular greenhouse gas compared to a pound of carbon dioxide. The weights of each of the contributing emissions in Table 11-4 are multiplied by their global warming potential and shown in Table 11-5.

Both process and fuel-related, as well as the total waterborne emissions are shown in Table 11-6. Definitions of process and fuel-related emissions are provided in this chapter, as well as in the glossary.

Table 11-5

**Greenhouse Gas Summary for the Production of Polyether Polyol for Rigid Foam Polyurethane  
(lb carbon dioxide equivalents per 1,000 lb Polyol or kg carbon dioxide equivalents per 1,000 kg Polyol)**

	<u>Fuel-related CO2 Equiv.</u>	<u>Process CO2 Equiv.</u>	<u>Total CO2 Equiv.</u>
Carbon Dioxide - Fossil	3,237	58.3	3,295
Methane	304	93.0	397
Nitrous Oxide	25.5	0	25.5
Methyl Bromide	3.9E-05	0	3.9E-05
Methyl Chloride	4.1E-04	0	4.1E-04
Trichloroethane	1.4E-04	0	1.4E-04
Chloroform	8.6E-05	0	8.6E-05
Methylene Chloride	0.0018	0	0.0018
Carbon Tetrachloride	0.0050	0.25	0.25
CFC 13 (Methane, trichlorofluor	0.050	0.063	0.11
HCFC-123	0	0.0064	0.0064
HCFC-22	0	0.0011	0.0011
HFC-134a	0	0.12	0.12
Total	<u>3,566</u>	<u>152</u>	<u>3,718</u>

Note: The 100 year global warming potentials used in this table are as follows: fossil carbon dioxide--1, methane--25, nitrous oxide--298, methyl bromide--5, methyl chloride--16, trichloroethane--140, chloroform--30, methylene chloride--10, carbon tetrachloride--1400, CFC-013--11,700, HCFC-22--1810, HCFC-123--77, and HFC-134a--1430.

Source: Franklin Associates, A Division of ERG

**Table 11-6**  
**Waterborne Emissions for the Production of Polyether Polyol for Rigid Foam Polyurethane**  
 (lb per 1,000 lb or kg per 1,000 kg)  
 (page 1 of 2)

	Process emissions	Fuel-related emissions	Total emissions
<b>Waterborne Wastes</b>			
1-methylfluorene	1.0E-08	1.1E-08	2.1E-08
2,4 dimethylphenol	4.8E-06	4.7E-06	9.5E-06
2-Hexanone	1.1E-06	1.1E-06	2.2E-06
2-methylnaphthalene	2.6E-06	2.6E-06	5.2E-06
4-methyl-2-pentanone	3.8E-07	3.9E-07	7.7E-07
Acetone	9.1E-07	9.4E-07	1.8E-06
Acid (benzoic)	1.7E-04	1.7E-04	3.4E-04
Acid (hexanoic)	3.6E-05	3.5E-05	7.1E-05
Acid (unspecified)	7.56	0	7.56
Alkylated Benzenes	3.2E-05	3.1E-05	6.3E-05
Alkylated Fluorenes	1.9E-06	1.8E-06	3.7E-06
Alkylated Naphthalenes	5.3E-07	5.1E-07	1.0E-06
Alkylated Phenanthrenes	2.2E-07	2.1E-07	4.3E-07
Aluminum	0.016	0.016	0.032
Ammonia	0.0056	0.0048	0.010
Ammonium	0	9.8E-05	9.8E-05
Antimony	9.8E-06	9.6E-06	1.9E-05
Arsenic	3.3E-05	3.5E-05	6.8E-05
Barium	0.21	0.21	0.42
Benzene	1.9E-04	1.8E-04	3.7E-04
Beryllium	2.1E-06	2.0E-06	4.1E-06
BOD	1.16	0.17	1.33
Boron	5.3E-04	5.2E-04	0.0011
Bromide	0.021	0.021	0.042
Cadmium	5.1E-06	6.4E-06	1.2E-05
Calcium	0.35	0.34	0.70
Chlorides (methyl chloride)	3.6E-09	3.8E-09	7.4E-09
Chlorides (unspecified)	0	4.25	4.25
Chromium (unspecified)	4.2E-04	4.1E-04	8.3E-04
Cobalt	3.8E-06	3.7E-06	7.5E-06
COD	1.09	0.074	1.17
Copper	4.6E-05	7.5E-05	1.2E-04
Cresols	1.0E-05	1.0E-05	2.0E-05
Cyanide	6.5E-09	6.8E-09	1.3E-08
Cymene	9.0E-09	9.4E-09	1.8E-08
Dibenzofuran	1.7E-08	1.8E-08	3.5E-08
Dibenzothiophene	1.4E-08	1.4E-08	2.8E-08
Dissolved Solids	44.3	4.30	48.6
Ethylbenzene	1.6E-05	9.9E-06	2.6E-05
Fluorine/Fluorides	8.7E-07	0.0016	0.0016
Hydrocarbons	0.70	3.3E-05	0.70
Iron	0.029	0.037	0.066
Lead	8.7E-05	8.8E-05	1.8E-04
Lithium	0.067	0.072	0.14
Magnesium	0.071	0.069	0.14
Manganese	1.0E-04	0.0028	0.0030
Mercury	6.8E-07	2.1E-07	9.0E-07
Methyl Ethyl Ketone (MEK)	7.3E-09	7.5E-09	1.5E-08
Molybdenum	3.9E-06	3.8E-06	7.7E-06



Table 11-6  
Waterborne Emissions for the Production of Polyether Polyol for Rigid Foam Polyurethane  
(lb per 1,000 lb or kg per 1,000 kg)  
(page 2 of 2)

	Process emissions	Fuel-related emissions	Total emissions
Naphthalene	3.1E-06	3.0E-06	6.1E-06
Nickel	4.0E-05	3.9E-05	7.9E-05
Nitrates	0	2.4E-04	2.4E-04
Nitrogen (ammonia)	0.91	8.5E-05	0.91
Oil	0.0057	0.0053	0.011
Pentamethyl benzene	6.8E-09	7.0E-09	1.4E-08
Phenanthrene	1.4E-07	1.3E-07	2.7E-07
Phenol/Phenolic Compounds	1.01	9.5E-05	1.01
Radionuclides (unspecified) (1)	0	1.7E-07	1.7E-07
Selenium	2.3E-06	3.6E-05	3.9E-05
Silver	2.1E-04	2.1E-04	4.2E-04
Sodium	1.01	0.98	2.00
Strontium	0.0093	0.0091	0.018
Sulfates	0.0073	0.17	0.17
Sulfides	9.0E-05	3.7E-05	1.3E-04
Sulfur	4.2E-04	4.2E-04	8.4E-04
Surfactants	8.6E-05	8.4E-05	1.7E-04
Suspended Solids	1.82	1.75	3.57
Thallium	2.1E-06	2.0E-06	4.1E-06
Tin	3.9E-05	3.8E-05	7.7E-05
Titanium	1.5E-04	1.5E-04	3.0E-04
Toluene	2.3E-04	1.6E-04	3.9E-04
Total Alkalinity	0.0079	0.0076	0.016
Total Biphenyls	2.1E-06	2.0E-06	4.1E-06
Total Dibenzo-thiophenes	6.4E-09	6.3E-09	1.3E-08
Vanadium	1.8E-05	1.5E-05	3.3E-05
Xylenes	8.9E-05	8.6E-05	1.7E-04
Yttrium	1.1E-06	1.1E-06	2.3E-06
Zinc	3.6E-04	4.0E-04	7.6E-04
Lead 210	1.8E-14	0	1.8E-14
n-Decane	4.9E-06	0	4.9E-06
n-Docosane	9.7E-08	0	9.7E-08
n-Dodecane	9.4E-06	0	9.4E-06
n-Eicosane	2.6E-06	0	2.6E-06
n-Hexacosane	6.0E-08	0	6.0E-08
n-Hexadecane	1.0E-05	0	1.0E-05
n-Octadecane	2.5E-06	0	2.5E-06
Radium 226	6.2E-12	0	6.2E-12
Radium 228	3.2E-14	0	3.2E-14
Sodium Hydroxide	1.08	0	1.08
Styrene	5.9E-07	0	5.9E-07
Tetradecane	4.0E-06	0	4.0E-06
TOC	5.9E-04	0	5.9E-04

(1) The units for Radionuclides are Curies per 1,000 lbs of product. The total Radionuclides using metric units are 14.06 kBq per 1,000 kgs of product.

Source: Franklin Associates, A Division of ERG

## CHAPTER 12

CRADLE-TO-PRECURSOR LIFE CYCLE INVENTORY RESULTS FOR  
POLYETHER POLYOL USED FOR FLEXIBLE FOAM POLYURETHANE

This chapter presents LCI results for the production of polyether polyol used for flexible foam polyurethane (cradle-to-polyol). The results are given on the bases of 1,000 pounds and 1,000 kilograms of the polyol. Figure 12-1 presents the flow diagram for the production of the polyol. Process descriptions and individual process tables for each box shown in the flow diagram can be found in Appendix L of the Appendices (separate document). Although a number of raw materials (coconut oil, palm oil, palm kernel oil, etc.) can be used to produce glycerine, palm kernel oil was chosen in this analysis.

Primary data was collected for olefins, chlorine/caustic soda, and polyether polyol production. A weighted average using production quantities was calculated from the olefins production data collected from three leading producers (8 thermal cracking units) in North America. As of 2003, there were 16 olefin producers and at least 29 olefin plants in the U.S. The captured production amount is approximately 30 percent of the available capacity for olefin production. Numerous coproduct streams are produced from the olefins hydrocracker. Fuel gas and off-gas were two of the coproducts produced that were exported to another process for fuel. When these fuel coproducts are exported from the hydrocracker, they carry with them the allocated share of the inputs and outputs for their production. The separate appendices provide an in-depth discussion of this allocation. A mass basis was used to allocate the credit to the remaining material coproducts.

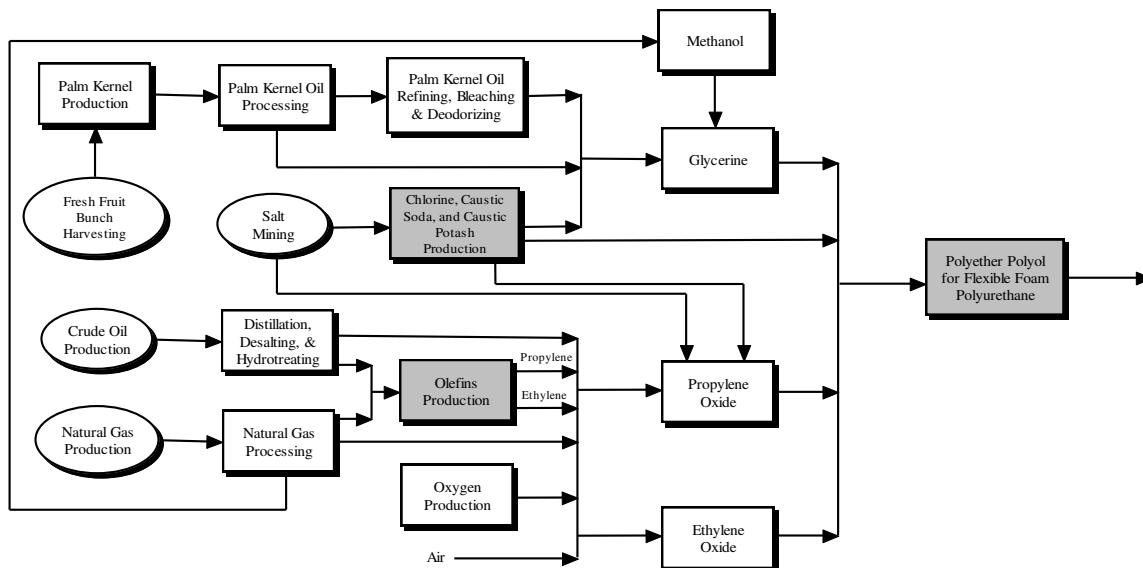

Figure 12-1. Flow diagram for the manufacture of polyether polyol for flexible foam polyurethane. Shaded boxes represent partial or complete data provided by manufacturers specifically for this APC analysis.

The chlorine/caustic data collected for this module represent 1 producer and 3 plants in the U.S. Besides this recently collected data, 2 diaphragm cell datasets and 2 mercury cell datasets were used from the early 1990s. The mercury cell technology is more likely to be used to produce high-purity caustic, than chlorine to be used in EDC; however, a small percentage of chlorine used in EDC does still come from mercury cells. For this analysis, it is estimated that 91.4 percent of the cell technology is diaphragm and membrane, while 8.6 percent of the cell technology is mercury. The collected datasets were weighted using these fractions. As of 2003 there were 20 chlorine/caustic producers and 41 chlorine/caustic plants in the U.S. for the three standard technologies. The captured production amount is approximately 30 percent of the available capacity for all chlorine production in the U.S. Caustic soda and hydrogen are the coproducts produced with chlorine. A mass basis was used to allocate the credit to the coproducts.

A weighted average using production amounts was calculated from the polyol production data from five plants collected from five leading producers in North America. As of 2002, it is estimated that for all polyurethane applications, there were 7 polyether polyol producers and 9 polyether polyol plants in the U.S. The captured production amount is approximately 45 percent of the available capacity for polyol production in the U.S. and Canada. Heat was a coproduct for two producers. The energy for exported heat was reported separately as recovered energy.

## **DESCRIPTION OF TABLES**

The average gross energy required to produce the polyether polyol for flexible foam polyurethane is 41.1 million Btu per 1,000 pounds or 95.7 GJ per 1,000 kilograms. Tables 12-1 and 12-2 show the breakdown of energy requirements for the production of polyol by category and source, respectively. Precombustion energy (the energy used to extract and process fuels used for process energy and transportation energy) is included in the results shown in these tables. Table L-1 in the Appendices (separate document) provides the aggregated unit process energy (cradle-to-polyol) for the production of the polyol. Natural gas and petroleum used as raw material inputs for the production of the polyol, reported as energy of material resource in Table 12-1, are included in the totals for natural gas and petroleum energy in Table 12-2. Petroleum-based fuels (e.g. diesel fuel) are the dominant energy source for transportation. Non-fossil sources, such as hydropower, nuclear and other (geothermal, wind, etc.) shown in Table 12-2 are used to generate purchased electricity along with the fossil fuels.

Table 12-1

Energy by Category for the Production of Polyether Polyol  
for Flexible Foam Polyurethane

	<u>MMBtu per 1,000 pounds</u>	<u>GJ per 1,000 kilograms</u>
<b>Energy Category</b>		
Process (1)	24.8	57.8
Transportation	0.67	1.57
Energy of Material Resource	<u>15.6</u>	<u>36.3</u>
<b>Total Energy</b>	<b>41.1</b>	<b>95.7</b>
<b>Energy Category (Percent)</b>		
Process	60%	60%
Transportation	2%	2%
Energy of Material Resource	<u>38%</u>	<u>38%</u>
<b>Total</b>	<b>100%</b>	<b>100%</b>

---

(1) Process energy includes recovered energy, which is shown as a credit.

Source: Franklin Associates, A Division of ERG

Table 12-2

Energy Profile for the Production of Polyether Polyol  
for Flexible Foam Polyurethane

	<u>MM Btu per 1,000 pounds</u>	<u>GJ per 1,000 kilograms</u>
<b>Energy Source</b>		
Natural Gas	25.6	59.4
Petroleum	9.77	22.7
Coal	4.09	9.52
Hydropower	0.15	0.36
Nuclear	1.31	3.05
Wood	0.11	0.26
Other	0.24	0.56
<b>Recovered Energy (1)</b>	<u>-0.082</u>	<u>-0.19</u>
<b>Total Energy</b>	<b>41.2</b>	<b>95.7</b>
<b>Energy Source (Percent)</b>		
Natural Gas	62%	62%
Petroleum	24%	24%
Coal	10%	10%
Hydropower	0%	0%
Nuclear	3%	3%
Wood	0%	0%
Other	<u>1%</u>	<u>1%</u>
<b>Total</b>	<b>100%</b>	<b>100%</b>

- (1) Recovered energy represents the recovery of energy as steam or condensate. Because this energy will be used by other processes, it is shown as a negative entry (credit).

Source: Franklin Associates, A Division of ERG

Table 12-3 shows the weight of solid waste generated during the production of polyether polyol for flexible foam polyurethane. The process solid waste, those wastes produced directly from the cradle-to-precursor processes, includes wastes that are incinerated both for disposal and for waste-to-energy, as well as landfilled. These categories have been provided separately. Solid waste from fuel production and combustion is also presented.

Both process and fuel-related, as well as total, atmospheric emissions are shown in Table 12-4. As defined in the report glossary, process emissions are those released directly from the sequence of processes that are used to extract, transform, fabricate, or otherwise affect changes on a material or product during its life cycle, while fuel-related emissions are those associated with the combustion of fuels used for process energy and transportation energy.

Table 12-3

Solid Wastes by Weight for the Production of Polyether Polyol  
for Flexible Foam Polyurethane

	<u>lb per 1,000 pounds</u>	<u>kg per 1,000 kilograms</u>
<b>Solid Wastes By Weight</b>		
Process		
Landfilled	30.9	30.9
Incinerated	5.46	5.46
Waste-to-Energy	0.0050	0.0050
Fuel	<u>155</u>	<u>155</u>
<b>Total</b>	<b>191</b>	<b>191</b>
<b>Weight Percent by Category</b>		
Process		
Landfilled	16%	16%
Incinerated	3%	3%
Waste-to-Energy	0%	0%
Fuel	<u>81%</u>	<u>81%</u>
<b>Total</b>	<b>100 %</b>	<b>100 %</b>

---

Source: Franklin Associates, A Division of ERG

Table 12-4  
 Atmospheric Emissions for the Production of Polyether Polyol for Flexible Foam Polyurethane  
 (lb per 1,000 lb or kg per 1,000 kg)  
 (page 1 of 2)

	Process emissions	Fuel-related emissions	Total emissions
<b>Atmospheric Emissions</b>			
Carbon Dioxide - Fossil	147	3,377	3,524
Methane	5.69	13.9	19.6
Nitrous Oxide	1.0E-04	0.072	0.072
Carbon Dioxide - Non-Fossil	16.9	34.6	51.5
Particulates (unspecified)	0.092	0.69	0.78
Particulates (PM10)	0.16	0.65	0.82
Particulates (PM2.5)	0.017	0.33	0.34
Nitrogen Oxides	0.20	6.27	6.47
Sulfur Dioxide	1.19	7.24	8.44
Sulfur Oxides	0.031	2.07	2.10
VOC (unspecified)	0.46	0.57	1.03
TNMOC (unspecified)	0	0.027	0.027
Hydrocarbons (unspecified)	0	0.13	0.13
Carbon Monoxide	0.16	1.82	1.98
1,3 Butadiene	0	1.1E-06	1.1E-06
2,4-Dinitrotoluene	0	6.9E-09	6.9E-09
2-Chloroacetophenone	0	1.7E-07	1.7E-07
5-Methyl Chrysene	0	4.6E-09	4.6E-09
Acenaphthene	0	1.1E-07	1.1E-07
Acenaphthylene	0	5.2E-08	5.2E-08
Acetophenone	0	3.7E-07	3.7E-07
acrolein	0	7.7E-04	7.7E-04
Aldehydes (Acetaldehyde)	0	2.0E-04	2.0E-04
Aldehydes (Formaldehyde)	0	0.0027	0.0027
Aldehydes (Propionaldehyde)	0	9.3E-06	9.3E-06
Aldehydes (unspecified)	0.032	1.8E-04	0.032
Ammonia	0.043	6.8E-04	0.044
Ammonia Chloride	0	1.3E-04	1.3E-04
Anthracene	0	4.4E-08	4.4E-08
Antimony	6.1E-07	5.5E-06	6.1E-06
Arsenic	7.7E-08	1.1E-04	1.1E-04
Benzene	0.057	0.056	0.11
Benzo(a)anthracene	0	1.7E-08	1.7E-08
Benzo(a)pyrene	0	7.9E-09	7.9E-09
Benzo(b,j,k)fluoranthene	0	2.3E-08	2.3E-08
Benzo(g,h,i) perylene	0	5.6E-09	5.6E-09
Benzyl Chloride	0	1.7E-05	1.7E-05
Beryllium	0	6.3E-06	6.3E-06
Biphenyl	0	3.5E-07	3.5E-07
Bis (2-ethylhexyl) Phthalate (DEHP)	0	1.8E-06	1.8E-06
Bromoform	0	9.6E-07	9.6E-07
Cadmium	0	3.3E-05	3.3E-05
Carbon Disulfide	0	3.2E-06	3.2E-06
Carbon Tetrachloride	2.0E-04	8.2E-06	2.0E-04
CFC 13 (Methane, trichlorofluoro-)	6.5E-06	3.9E-06	1.0E-05
Chlorobenzene	0	5.4E-07	5.4E-07
Chloroform	0	1.4E-06	1.4E-06
Chlorine	0.0024	1.4E-04	0.0025
Chromium	2.0E-07	8.8E-05	8.8E-05
Chromium (VI)	0	1.6E-05	1.6E-05
Chrysene	0	2.1E-08	2.1E-08
Cobalt	0	1.3E-04	1.3E-04

Table 12-4

**Atmospheric Emissions for the Production of Polyether Polyol for Flexible Foam Polyurethane**  
(lb per 1,000 lb or kg per 1,000 kg)  
(page 2 of 2)

	Process emissions	Fuel-related emissions	Total emissions
Copper	0	2.6E-06	2.6E-06
Cumene	0	1.3E-07	1.3E-07
Cyanide	0	6.1E-05	6.1E-05
Dimethyl Sulfate	0	1.2E-06	1.2E-06
Dioxins (unspecified)	0	3.0E-07	3.0E-07
Ethyl Chloride	0	1.0E-06	1.0E-06
Ethylbenzene	0.83	0.0063	0.83
Ethylene Dibromide	1.3E-06	8.0E-07	2.1E-06
Ethylene Dichloride	0	9.8E-07	9.8E-07
Fluoranthene	0	1.5E-07	1.5E-07
Fluorene	0	1.9E-07	1.9E-07
Fluorides	0	0.0011	0.0011
Furans (unspecified)	0	4.6E-10	4.6E-10
Hydrogen Chloride	3.3E-04	0.25	0.25
Hexane	0	1.6E-06	1.6E-06
Hydrogen Fluoride	0	0.030	0.030
Indeno(1,2,3-cd)pyrene	0	1.3E-08	1.3E-08
Isophorone (C9H14O)	0	1.4E-05	1.4E-05
Kerosene	0	2.4E-04	2.4E-04
Lead	1.1E-07	2.1E-04	2.1E-04
Magnesium	0	0.0023	0.0023
Manganese	0	4.4E-04	4.4E-04
Mercaptan	0.0039	0.0053	0.0092
Mercury	1.7E-04	5.4E-05	2.3E-04
Metals (unspecified)	0	0.0076	0.0076
Methyl Bromide	0	3.9E-06	3.9E-06
Methyl Chloride	0	1.3E-05	1.3E-05
Methyl Ethyl Ketone	0	9.6E-06	9.6E-06
Methyl Hydrazine	0	4.2E-06	4.2E-06
Methyl Methacrylate	0	4.9E-07	4.9E-07
Methyl Tert Butyl Ether (MTBE)	0	8.6E-07	8.6E-07
Methylene Chloride	0	2.1E-04	2.1E-04
Naphthalene	0	4.7E-05	4.7E-05
Nickel	1.7E-06	0.0015	0.0015
Organics (unspecified)	0.10	0.0011	0.10
Perchloroethylene	0	1.0E-05	1.0E-05
Phenanthrene	0	5.6E-07	5.6E-07
Phenols	0	8.4E-05	8.4E-05
Polyaromatic Hydrocarbons (total)	1.7E-05	1.9E-05	3.6E-05
Propylene	0	7.2E-05	7.2E-05
Propylene Oxide	0.40	0	0.40
Pyrene	0	6.8E-08	6.8E-08
Radionuclides (unspecified) (1)	0	0.013	0.013
Selenium	0	2.9E-04	2.9E-04
Styrene	0	6.1E-07	6.1E-07
Toluene	0.088	0.081	0.17
Trichloroethane	0	4.9E-07	4.9E-07
Vinyl Acetate	0	1.9E-07	1.9E-07
Xylenes	0.051	0.047	0.099
Zinc	0	1.7E-06	1.7E-06
Acid (unknown)	0.038	0	0.038
Ethylene Oxide	0.011	0	0.011
HCFC-123	9.2E-05	0	9.2E-05
HCFC-22	7.5E-07	0	7.5E-07
HFC-134a	9.2E-05	0	9.2E-05
Hydrogen	0.0038	0	0.0038
NMVOC, non-methane volatile organic compounds, unspecified origin	0.20	0	0.20
Non-Methane Hydrocarbons	7.32	0	7.32

(1) The units for Radionuclides are Curies per 1,000 lbs of product. The total Radionuclides using metric units are 1,091,400 kBq per 1,000 kgs of product.

Source: Franklin Associates, A Division of ERG



Table 12-5 provides a greenhouse gas (GHG) summary for the production of polyether polyol for flexible foam polyurethane. The primary three atmospheric emissions reported in this analysis that contribute to global warming are fossil fuel-derived carbon dioxide, methane, and nitrous oxide. (Non-fossil carbon dioxide emissions, such as those from the burning of wood, are considered part of the natural carbon cycle and are not considered a net contributor to global warming.) The 100-year global warming potential for each of these substances as reported in the Intergovernmental Panel on Climate Change (IPCC) 2007 report are shown in a note at the bottom of Table 12-5. The global warming potential represents the relative global warming contribution of a pound of a particular greenhouse gas compared to a pound of carbon dioxide. The weights of each of the contributing emissions in Table 12-4 are multiplied by their global warming potential and shown in Table 12-5.

Both process and fuel-related, as well as the total waterborne emissions are shown in Table 12-6. Definitions of process and fuel-related emissions are provided in this chapter, as well as in the glossary.

Table 12-5

**Greenhouse Gas Summary for the Production of Polyether Polyol for Flexible Foam Polyurethane  
(lb carbon dioxide equivalents per 1,000 lb Polyol or kg carbon dioxide equivalents per 1,000 kg Polyol)**

	<u>Fuel-related CO2 Equiv.</u>	<u>Process CO2 Equiv.</u>	<u>Total CO2 Equiv.</u>
Carbon Dioxide - Fossil	3,377	147	3,524
Methane	347	142	489
Nitrous Oxide	21.6	0.030	21.6
Methyl Bromide	2.0E-05	0	2.0E-05
Methyl Chloride	2.1E-04	0	2.1E-04
Trichloroethane	6.9E-05	0	6.9E-05
Chloroform	4.3E-05	0	4.3E-05
Methylene Chloride	0.0021	0	0.0021
Carbon Tetrachloride	0.012	0.27	0.29
CFC 13 (Methane, trichlorofluor	0.046	0.076	0.12
HCFC-123	0	0.0071	0.0071
HCFC-22	0	0.0014	0.0014
HFC-134a	0	0.13	0.13
Total	<u>3,745</u>	<u>290</u>	<u>4,035</u>

Note: The 100 year global warming potentials used in this table are as follows: fossil carbon dioxide--1, methane--25, nitrous oxide--298, methyl bromide--5, methyl chloride--16, trichloroethane--140, chloroform--30, methylene chloride--10, carbon tetrachloride--1400, CFC-013--11,700, HCFC-22--1810, HCFC-123--77, and HFC-134a--1430.

Source: Franklin Associates, A Division of ERG

Table 12-6

**Waterborne Emissions for the Production of Polyether Polyol for Flexible Foam Polyurethane**  
(lb per 1,000 lb or kg per 1,000 kg)  
(page 1 of 2)

	Process emissions	Fuel-related emissions	Total emissions
<b>Waterborne Wastes</b>			
1-methylfluorene	1.3E-08	1.2E-08	2.5E-08
2,4 dimethylphenol	6.1E-06	5.1E-06	1.1E-05
2-Hexanone	1.4E-06	1.2E-06	2.6E-06
2-methylnaphthalene	3.3E-06	2.8E-06	6.1E-06
4-methyl-2-pentanone	5.0E-07	4.4E-07	9.4E-07
Acetone	1.2E-06	1.0E-06	2.2E-06
Acid (benzoic)	2.2E-04	1.8E-04	4.0E-04
Acid (hexanoic)	4.6E-05	3.8E-05	8.4E-05
Acid (unspecified)	8.52	0	8.52
Alkylated Benzenes	4.1E-05	3.4E-05	7.5E-05
Alkylated Fluorenes	2.4E-06	2.0E-06	4.3E-06
Alkylated Naphthalenes	6.7E-07	5.5E-07	1.2E-06
Alkylated Phenanthrenes	2.8E-07	2.3E-07	5.1E-07
Aluminum	0.020	0.018	0.038
Ammonia	0.017	0.0046	0.022
Ammonium	0	1.1E-04	1.1E-04
Antimony	1.3E-05	1.0E-05	2.3E-05
Arsenic	4.2E-05	3.7E-05	7.9E-05
Barium	0.27	0.22	0.50
Benzene	2.4E-04	1.9E-04	4.3E-04
Beryllium	2.6E-06	2.2E-06	4.8E-06
BOD	0.85	0.37	1.22
Boron	6.8E-04	5.7E-04	0.0012
Bromide	0.027	0.022	0.049
Cadmium	6.5E-06	6.9E-06	1.3E-05
Calcium	0.45	0.37	0.82
Chlorides (methyl chloride)	4.7E-09	4.2E-09	9.0E-09
Chlorides (unspecified)	0	4.58	4.58
Chromium (unspecified)	0.0034	4.4E-04	0.0038
Cobalt	4.8E-06	4.0E-06	8.8E-06
COD	3.45	0.072	3.52
Copper	5.9E-05	8.1E-05	1.4E-04
Cresols	1.3E-05	1.1E-05	2.4E-05
Cyanide	8.5E-09	7.6E-09	1.6E-08
Cymene	1.2E-08	1.0E-08	2.2E-08
Dibenzofuran	2.2E-08	2.0E-08	4.2E-08
Dibenzothiophene	1.8E-08	1.6E-08	3.4E-08
Dissolved Solids	51.3	4.61	55.9
Ethylbenzene	2.1E-05	1.1E-05	3.1E-05
Fluorine/Fluorides	2.4E-05	0.0017	0.0017
Hydrocarbons	0.89	3.6E-05	0.89
Iron	0.037	0.039	0.076
Lead	1.1E-04	9.5E-05	2.1E-04
Lithium	0.089	0.082	0.17
Magnesium	0.090	0.074	0.16
Manganese	1.3E-04	0.0028	0.0029
Mercury	7.9E-07	2.3E-07	1.0E-06
Metal (unspecified)	1.00	0	1.00
Methyl Ethyl Ketone (MEK)	9.5E-09	8.4E-09	1.8E-08
Molybdenum	5.0E-06	4.1E-06	9.2E-06

Table 12-6

**Waterborne Emissions for the Production of Polyether Polyol for Flexible Foam Polyurethane**  
(lb per 1,000 lb or kg per 1,000 kg)  
(page 2 of 2)

	Process emissions	Fuel-related emissions	Total emissions
Naphthalene	4.0E-06	3.3E-06	7.2E-06
Nickel	5.1E-05	4.2E-05	9.3E-05
Nitrates	1.00	2.6E-04	1.00
Nitrogen (ammonia)	0.0025	9.2E-05	0.0026
Oil	0.0097	0.0053	0.015
Pentamethyl benzene	8.8E-09	7.8E-09	1.7E-08
Phenanthrene	1.7E-07	1.4E-07	3.2E-07
Phenol/Phenolic Compounds	1.14	9.5E-05	1.14
Radionuclides (unspecified) (1)	0	1.9E-07	1.9E-07
Selenium	2.9E-06	3.9E-05	4.2E-05
Silver	2.7E-04	2.2E-04	5.0E-04
Sodium	1.29	1.05	2.35
Strontium	0.012	0.0098	0.022
Sulfates	0.0093	0.18	0.19
Sulfides	1.0E-04	3.4E-05	1.4E-04
Sulfur	5.4E-04	4.5E-04	0.0010
Surfactants	1.1E-04	9.0E-05	2.0E-04
Suspended Solids	2.39	1.88	4.27
Thallium	2.7E-06	2.2E-06	4.8E-06
Tin	5.0E-05	4.1E-05	9.1E-05
Titanium	1.9E-04	1.6E-04	3.5E-04
Toluene	2.9E-04	1.8E-04	4.7E-04
Total Alkalinity	0.010	0.0082	0.018
Total Biphenyls	2.7E-06	2.2E-06	4.9E-06
Total Dibenzo-thiophenes	8.2E-09	6.8E-09	1.5E-08
Vanadium	2.2E-05	1.4E-05	3.6E-05
Xylenes	1.1E-04	9.2E-05	2.1E-04
Yttrium	1.5E-06	1.2E-06	2.7E-06
Zinc	0.0016	4.3E-04	0.0020
Acetaldehyde	0.011	0	0.011
Lead 210	2.3E-14	0	2.3E-14
n-Decane	6.3E-06	0	6.3E-06
n-Docosane	1.3E-07	0	1.3E-07
n-Dodecane	1.2E-05	0	1.2E-05
n-Eicosane	3.3E-06	0	3.3E-06
n-Hexacosane	7.9E-08	0	7.9E-08
n-Hexadecane	1.3E-05	0	1.3E-05
n-Octadecane	3.3E-06	0	3.3E-06
Radium 226	7.9E-12	0	7.9E-12
Radium 228	4.0E-14	0	4.0E-14
Sodium Hydroxide	1.22	0	1.22
Styrene	7.5E-07	0	7.5E-07
Tetradecane	5.1E-06	0	5.1E-06
TOC	0.011	0	0.011

(1) The units for Radionuclides are Curies per 1,000 lbs of product. The total Radionuclides using metric units are 15.23 kBq per 1,000 kgs of product.

Source: Franklin Associates, A Division of ERG

CHAPTER 13

CRADLE-TO-PRECURSOR LIFE CYCLE INVENTORY RESULTS FOR MDI

This chapter presents LCI results for the production of pure and polymeric methylene diphenylene diisocyanate (MDI) (cradle-to-MDI). The market split is approximately 80 percent polymeric MDI and 20 percent pure MDI. The results are given on the bases of 1,000 pounds and 1,000 kilograms of MDI. Figure 13-1 presents the flow diagram for the production of MDI. Process descriptions and individual process tables for each box shown in the flow diagram can be found in Appendix M of the Appendices (separate document).

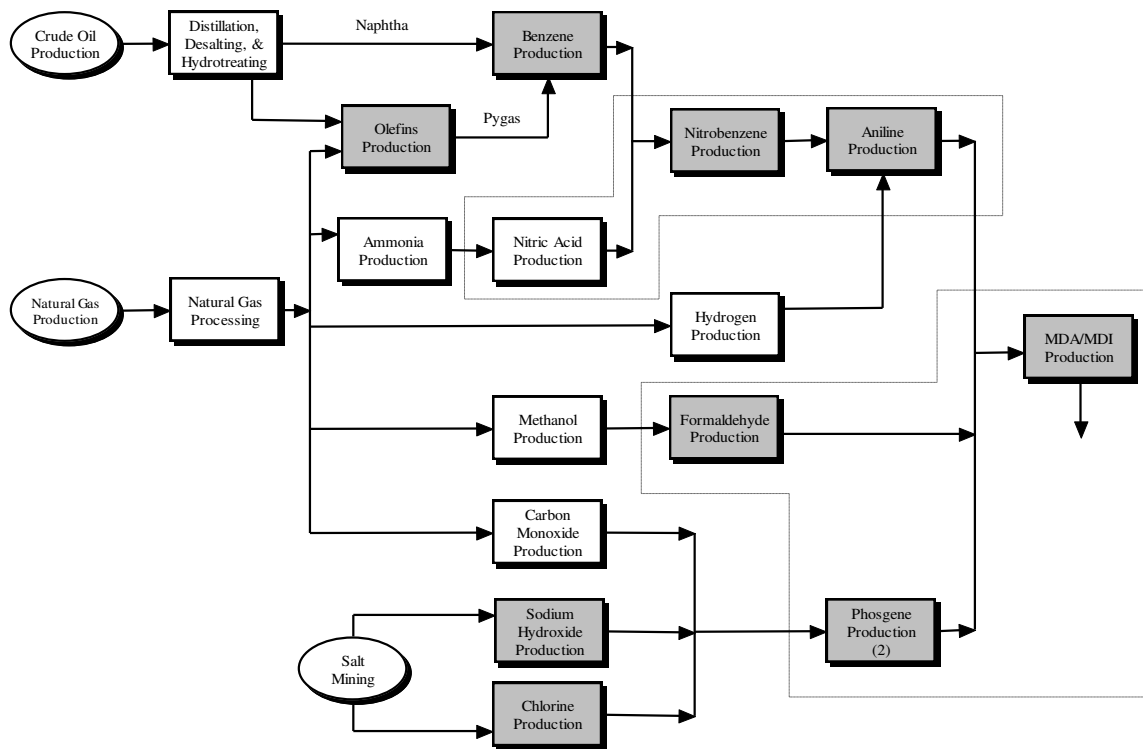

Figure 13-1. Flow diagram for the manufacture of methylene diphenylene diisocyanate (MDI). Shaded boxes represent partial or complete data provided by manufacturers specifically for this analysis. Boxes within the dotted lines are included in an aggregated dataset.

Primary data was collected for olefins, benzene, chlorine/caustic soda, nitric acid/nitrobenzene/aniline, and formaldehyde/phosgene/MDA/MDI production. A weighted average using production quantities was calculated from the olefins production data collected from three leading producers (8 thermal cracking units) in North America. As of 2003, there were 16 olefin producers and at least 29 olefin plants in the U.S. The captured production amount is approximately 30 percent of the available capacity for olefin production. Numerous coproduct streams are produced from the olefins hydrocracker. Fuel gas and off-gas were two of the coproducts produced that were exported to another process for fuel. When these fuel coproducts are exported from the hydrocracker, they carry with them the allocated share of the inputs and outputs for their production. The separate appendices provide an in-depth discussion of this allocation. A mass basis was used to allocate the credit to the remaining material coproducts.

It is estimated that one-third of the benzene production is from pyrolysis gasoline and two-thirds are produced from catalytic reforming. These percentages were used to weight the collected datasets for benzene. Catalytic reforming is represented by 2 primary datasets from 1992. The benzene data collected for this analysis represent 1 producer and 1 plant in the U.S. using the pyrolysis gasoline production method. As of 2002 there were 22 benzene producers and 38 benzene plants in the U.S. for the three standard technologies. The captured production amount is approximately 10 percent of the available capacity for benzene production in the U.S. Numerous aromatic coproduct streams are produced during this process. Fuel gas and off-gas were two of the coproducts produced that were exported to another process for fuel. When these fuel coproducts are exported from the reactor, they carry with them the allocated share of the inputs and outputs for their production. The separate appendices provide an in-depth discussion of this allocation. A mass basis was used to allocate the credit the remaining aromatic products.

The chlorine/caustic data collected for this module represent 1 producer and 3 plants in the U.S. Besides this recently collected data, 2 diaphragm cell datasets and 2 mercury cell datasets were used from the early 1990s. The mercury cell technology is more likely to be used to produce high-purity caustic, than chlorine to be used in EDC; however, a small percentage of chlorine used in EDC does still come from mercury cells. For this analysis, it is estimated that 91.4 percent of the cell technology is diaphragm and membrane, while 8.6 percent of the cell technology is mercury. The collected datasets were weighted using these fractions. As of 2003 there were 20 chlorine/caustic producers and 41 chlorine/caustic plants in the U.S. for the three standard technologies. The captured production amount is approximately 30 percent of the available capacity for all chlorine production in the U.S. Caustic soda and hydrogen are the coproducts produced with chlorine. A mass basis was used to allocate the credit to the coproducts.

The nitric acid, nitrobenzene and aniline data collected for this module represent 2 producers and 2 plants in the U.S. As of 2002 there were 28 nitric acid producers and 49 nitric acid plants in the U.S. (Reference M-6). The captured production amount is approximately 90 percent of the available capacity for all nitric acid production in the U.S. As of 2002 there were 4 nitrobenzene producers and 5 nitrobenzene plants in the U.S. The captured production amount is more than 50 percent of the available capacity for all nitrobenzene production in the U.S. As of 2002 there were 6 aniline producers and 7 aniline plants in the U.S. The captured production amount is more than 50 percent of the available capacity for all aniline production in the U.S. Steam/heat is produced as a coproduct during the aniline production. The energy for exported steam/heat was reported separately as recovered energy.

A weighted average using production amounts was calculated from the formaldehyde/phosgene/MDA/MDI production data from four plants collected from four leading producers in North America. As of 2003, there were 4 MDI producers and 5 MDI plants in the U.S. The captured production amount is approximately 95 percent of the available capacity for MDI production in the U.S. and Canada. Hydrogen chloride is produced as a coproduct during this process. A mass basis was used to allocate the credit for the coproduct.

## DESCRIPTION OF TABLES

The average gross energy required to produce MDI is 25.7 million Btu per 1,000 pounds or 59.8 GJ per 1,000 kilograms. Tables 13-1 and 13-2 show the breakdown of energy requirements for the production of MDI by category and source, respectively. Precombustion energy (the energy used to extract and process fuels used for process energy and transportation energy) is included in the results shown in these tables. Table M-1 in the Appendices (separate document) provides the aggregated unit process energy (cradle-to-MDI) for the production of MDI. Natural gas and petroleum used as raw material inputs for the production of MDI, reported as energy of material resource in Table 13-1, are included in the totals for natural gas and petroleum energy in Table 13-2. Petroleum-based fuels (e.g. diesel fuel) are the dominant energy source for transportation. Non-fossil sources, such as hydropower, nuclear and other (geothermal, wind, etc.) shown in Table 13-2 are used to generate purchased electricity along with the fossil fuels.

Table 13-1

## Energy by Category for the Production of MDI

	<u>MMBtu per 1,000 pounds</u>	<u>GJ per 1,000 kilograms</u>
<b>Energy Category</b>		
Process (1)	11.2	26.1
Transportation	0.42	0.98
Energy of Material Resource	<u>14.0</u>	<u>32.7</u>
<b>Total Energy</b>	<b>25.7</b>	<b>59.8</b>
<b>Energy Category (Percent)</b>		
Process	44%	44%
Transportation	2%	2%
Energy of Material Resource	<u>55%</u>	<u>55%</u>
<b>Total</b>	<b>100%</b>	<b>100%</b>

---

(1) Process energy includes recovered energy, which is shown as a credit.

Source: Franklin Associates, A Division of ERG

Table 13-2

## Energy Profile for the Production of MDI

	<u>MM Btu per 1,000 pounds</u>	<u>GJ per 1,000 kilograms</u>
<b>Energy Source</b>		
Natural Gas	16.1	37.4
Petroleum	7.77	18.1
Coal	1.95	4.54
Hydropower	0.077	0.18
Nuclear	0.66	1.53
Wood	0.0070	0.016
Other	0.12	0.28
<b>Recovered Energy (1)</b>	<u>-0.96</u>	<u>-2.22</u>
<b>Total Energy</b>	<b>25.7</b>	<b>59.8</b>
<b>Energy Source (Percent)</b>		
Natural Gas	60%	60%
Petroleum	29%	29%
Coal	7%	7%
Hydropower	0%	0%
Nuclear	2%	2%
Wood	0%	0%
Other	<u>0%</u>	<u>0%</u>
<b>Total</b>	<b>100%</b>	<b>100%</b>

(1) Recovered energy represents the recovery of energy as steam or condensate. Because this energy will be used by other processes, it is shown as a negative entry (credit).

Source: Franklin Associates, A Division of ERG

Table 13-3 shows the weight of solid waste generated during the production of MDI. The total generated solid waste includes wastes that are incinerated both for disposal and for waste-to-energy, as well as landfilled. These categories have been provided separately.

Both process and fuel-related, as well as total, atmospheric emissions are shown in Table 13-4. As defined in the report glossary, process emissions are those released directly from the sequence of processes that are used to extract, transform, fabricate, or otherwise affect changes on a material or product during its life cycle, while fuel-related emissions are those associated with the combustion of fuels used for process energy and transportation energy.



Table 13-3

## Solid Wastes by Weight for the Production of MDI

	<u>lb per 1,000 pounds</u>	<u>kg per 1,000 kilograms</u>
<b>Solid Wastes By Weight</b>		
Process		
Landfilled	23.4	23.4
Incinerated	3.26	3.26
Waste-to-Energy	0.7511	0.7511
Fuel	<u>75.1</u>	<u>75.1</u>
<b>Total</b>	<b>103</b>	<b>103</b>
 <b>Weight Percent by Category</b>		
Process		
Landfilled	23%	23%
Incinerated	3%	3%
Waste-to-Energy	1%	1%
Fuel	<u>73%</u>	<u>73%</u>
<b>Total</b>	<b>100%</b>	<b>100%</b>

---

Source: Franklin Associates, A Division of ERG

**Table 13-4**  
**Atmospheric Emissions for the Production of MDI**  
**(lb per 1,000 lb or kg per 1,000 kg)**  
**(page 1 of 2)**

	Process emissions	Fuel-related emissions	Total emissions
<b>Atmospheric Emissions</b>			
Carbon Dioxide - Fossil	363	1,700	2,062
Methane	3.91	8.24	12.1
Nitrous Oxide	0	0.035	0.035
Carbon Dioxide - Non-Fossil	0	7.81	7.81
Particulates (unspecified)	0.011	0.33	0.34
Particulates (PM10)	0.069	0.23	0.30
Particulates (PM2.5)	0.018	0.13	0.15
Nitrogen Oxides	0.58	3.15	3.73
Sulfur Dioxide	0.81	3.60	4.42
Sulfur Oxides	0.18	0.86	1.04
VOC (unspecified)	0.30	0.36	0.65
TNMOC (unspecified)	0.74	0.012	0.75
Hydrocarbons (unspecified)	0	0.036	0.036
Carbon Monoxide	2.11	0.92	3.02
1,3 Butadiene	0	6.9E-07	6.9E-07
2,4-Dinitrotoluene	0	2.2E-09	2.2E-09
2-Chloroacetophenone	0	5.4E-08	5.4E-08
5-Methyl Chrysene	0	2.2E-09	2.2E-09
Acenaphthene	0	5.1E-08	5.1E-08
Acenaphthylene	0	2.5E-08	2.5E-08
Acetophenone	0	1.2E-07	1.2E-07
acrolein	0	1.9E-04	1.9E-04
Aldehydes (Acetaldehyde)	0	5.9E-05	5.9E-05
Aldehydes (Formaldehyde)	0	0.0011	0.0011
Aldehydes (Propionaldehyde)	0	2.9E-06	2.9E-06
Aldehydes (unspecified)	2.3E-04	8.8E-05	3.2E-04
Ammonia	0.27	2.0E-04	0.27
Ammonia Chloride	0	6.6E-05	6.6E-05
Anthracene	0	2.1E-08	2.1E-08
Antimony	7.0E-07	2.2E-06	2.9E-06
Arsenic	8.9E-08	4.8E-05	4.8E-05
Benzene	0.037	0.034	0.072
Benzo(a)anthracene	0	8.0E-09	8.0E-09
Benzo(a)pyrene	0	3.8E-09	3.8E-09
Benzo(b,j,k)fluoranthene	0	1.1E-08	1.1E-08
Benzo(g,h,i) perylene	0	2.7E-09	2.7E-09
Benzyl Chloride	0	5.4E-06	5.4E-06
Beryllium	0	2.7E-06	2.7E-06
Biphenyl	0	1.7E-07	1.7E-07
Bis(2-ethylhexyl) Phthalate (DEHP)	0	5.7E-07	5.7E-07
Bromoform	0	3.0E-07	3.0E-07
Cadmium	0	1.5E-05	1.5E-05
Carbon Disulfide	0	1.0E-06	1.0E-06
Carbon Tetrachloride	8.9E-05	1.9E-06	9.1E-05
CFC 13 (Methane, trichlorofluoro-)	7.5E-06	1.1E-06	8.7E-06
Chlorobenzene	0	1.7E-07	1.7E-07
Chloroform	0	4.6E-07	4.6E-07
Chlorine	6.8E-04	3.2E-05	7.1E-04
Chromium	2.3E-07	4.0E-05	4.0E-05
Chromium (VI)	0	7.9E-06	7.9E-06
Chrysene	0	1.0E-08	1.0E-08
Cobalt	0	3.4E-05	3.4E-05

Table 13-4  
 Atmospheric Emissions for the Production of MDI  
 (lb per 1,000 lb or kg per 1,000 kg)  
 (page 2 of 2)

	Process emissions	Fuel-related emissions	Total emissions
Copper	4.8E-05	8.4E-07	4.9E-05
Cumene	0	4.1E-08	4.1E-08
Cyanide	0	1.9E-05	1.9E-05
Dimethyl Sulfate	0	3.7E-07	3.7E-07
Dioxins (unspecified)	0	6.7E-08	6.7E-08
Ethyl Chloride	0	3.3E-07	3.3E-07
Ethylbenzene	0.0044	0.0040	0.0084
Ethylene Dibromide	1.5E-06	2.3E-07	1.7E-06
Ethylene Dichloride	0	3.1E-07	3.1E-07
Fluoranthene	0	7.1E-08	7.1E-08
Fluorene	0	9.1E-08	9.1E-08
Fluorides	0	3.5E-04	3.5E-04
Furans (unspecified)	0	2.3E-10	2.3E-10
Hydrogen Chloride	2.8E-04	0.12	0.12
Hexane	0	5.2E-07	5.2E-07
Hydrogen Fluoride	0	0.015	0.015
Indeno(1,2,3-cd)pyrene	0	6.1E-09	6.1E-09
Isophorone (C <sub>9</sub> H <sub>14</sub> O)	0	4.5E-06	4.5E-06
Kerosene	0	1.2E-04	1.2E-04
Lead	4.8E-06	7.9E-05	8.4E-05
Magnesium	0	0.0011	0.0011
Manganese	0	1.3E-04	1.3E-04
Mercaptan	0	0.0017	0.0017
Mercury	7.0E-05	2.1E-05	9.1E-05
Metals (unspecified)	0	0.0017	0.0017
Methyl Bromide	0	1.2E-06	1.2E-06
Methyl Chloride	0	4.1E-06	4.1E-06
Methyl Ethyl Ketone	0	3.0E-06	3.0E-06
Methyl Hydrazine	0	1.3E-06	1.3E-06
Methyl Methacrylate	0	1.6E-07	1.6E-07
Methyl Tert Butyl Ether (MTBE)	0	2.7E-07	2.7E-07
Methylene Chloride	0	6.4E-05	6.4E-05
Naphthalene	0	1.4E-05	1.4E-05
Nickel	2.0E-06	3.7E-04	3.8E-04
Organics (unspecified)	0.21	5.6E-04	0.21
Perchloroethylene	0	4.6E-06	4.6E-06
Phenanthrene	0	2.7E-07	2.7E-07
Phenols	0	2.1E-05	2.1E-05
Polyaromatic Hydrocarbons (total)	1.9E-05	8.0E-06	2.7E-05
Propylene	0	4.6E-05	4.6E-05
Pyrene	0	3.3E-08	3.3E-08
Radionuclides (unspecified) (1)	0	0.0067	0.0067
Selenium	0	1.3E-04	1.3E-04
Styrene	0	1.9E-07	1.9E-07
Toluene	0.057	0.051	0.11
Trichloroethane	0	1.6E-07	1.6E-07
Vinyl Acetate	0	5.9E-08	5.9E-08
Xylenes	0.033	0.030	0.063
Zinc	0	5.6E-07	5.6E-07
Dimethyl Ether	0.0010	0	0.0010
HCFC-123	3.7E-05	0	3.7E-05
HCFC-22	4.8E-04	0	4.8E-04
HFC-134a	3.7E-05	0	3.7E-05
Hydrogen	7.5E-04	0	7.5E-04
Methanol	0.0010	0	0.0010
Nickel Compounds	4.8E-04	0	4.8E-04
NMVOC, non-methane volatile organic compounds, unspecified origin	0.23	0	0.23
Non-Methane Hydrocarbons	0.56	0	0.56
PFCs	0.0048	0	0.0048
Sulfuric Acid	4.8E-06	0	4.8E-06

(1) The units for Radionuclides are Curies per 1,000 lbs of product. The total Radionuclides using metric units are 547,600 kBq per 1,000 kgs of product.

Source: Franklin Associates, A Division of ERG

Table 13-5 provides a greenhouse gas (GHG) summary for the production of MDI. The primary three atmospheric emissions reported in this analysis that contribute to global warming are fossil fuel-derived carbon dioxide, methane, and nitrous oxide. (Non-fossil carbon dioxide emissions, such as those from the burning of wood, are considered part of the natural carbon cycle and are not considered a net contributor to global warming.) The 100-year global warming potential for each of these substances as reported in the Intergovernmental Panel on Climate Change (IPCC) 2007 report are shown in a note at the bottom of Table 13-5. The global warming potential represents the relative global warming contribution of a pound of a particular greenhouse gas compared to a pound of carbon dioxide. The weights of each of the contributing emissions in Table 13-4 are multiplied by their global warming potential and shown in Table 13-5.

Both process and fuel-related, as well as the total waterborne emissions are shown in Table 13-6. Definitions of process and fuel-related emissions are provided previously in this chapter, as well as in the glossary.

Table 13-5

**Greenhouse Gas Summary for the Production of MDI**  
(lb carbon dioxide equivalents per 1,000 lb MDI or kg carbon dioxide equivalents per 1,000 kg MDI)

	<u>Fuel-related CO2 Equiv.</u>	<u>Process CO2 Equiv.</u>	<u>Total CO2 Equiv.</u>
Carbon Dioxide - Fossil	1,700	363	2,062
Methane	206	97.7	304
Nitrous Oxide	10.6	0	10.6
Methyl Bromide	6.2E-06	0	6.2E-06
Methyl Chloride	6.6E-05	0	6.6E-05
Trichloroethane	2.2E-05	0	2.2E-05
Chloroform	1.4E-05	0	1.4E-05
Methylene Chloride	6.4E-04	0	6.4E-04
Carbon Tetrachloride	0.0026	0.13	0.13
CFC 13 (Methane, trichlorofluor	0.013	0.088	0.10
HCFC-123	0	0.0029	0.0029
HCFC-22	0	0.87	0.87
HFC-134a	0	0.053	0.053
Total	<u>1,916</u>	<u>461</u>	<u>2,377</u>

Note: The 100 year global warming potentials used in this table are as follows: fossil carbon dioxide--1, methane--25, nitrous oxide--298, methyl bromide--5, methyl chloride--16, trichloroethane--140, chloroform--30, methylene chloride--10, carbon tetrachloride--1400, CFC-013--11,700, HCFC-22--1810, HCFC-123--77, and HFC-134a--1430.

Source: Franklin Associates, A Division of ERG

Table 13-6  
 Waterborne Emissions for the Production of MDI  
 (lb per 1,000 lb or kg per 1,000 kg)  
 (page 1 of 2)

	Process emissions	Fuel-related emissions	Total emissions
<b>Waterborne Wastes</b>			
1-methylfluorene	9.5E-09	7.2E-09	1.7E-08
2,4 dimethylphenol	4.9E-06	2.8E-06	7.7E-06
2-Hexanone	1.2E-06	6.5E-07	1.8E-06
2-methyl naphthalene	2.7E-06	1.5E-06	4.2E-06
4-methyl-2-pentanone	3.5E-07	2.6E-07	6.2E-07
Acetone	8.4E-07	6.3E-07	1.5E-06
Acid (benzoic)	1.8E-04	1.0E-04	2.8E-04
Acid (hexanoic)	3.7E-05	2.1E-05	5.8E-05
Alkylated Benzenes	3.3E-05	1.9E-05	5.2E-05
Alkylated Fluorenes	1.9E-06	1.1E-06	3.0E-06
Alkylated Naphthalenes	5.5E-07	3.0E-07	8.5E-07
Alkylated Phenanthrenes	2.3E-07	1.3E-07	3.5E-07
Aluminum	0.016	0.0096	0.026
Ammonia	0.029	0.0018	0.031
Ammonium	0	5.3E-05	5.3E-05
Antimony	1.0E-05	5.7E-06	1.6E-05
Arsenic	3.4E-05	2.0E-05	5.5E-05
Barium	0.22	0.12	0.34
Benzene	1.9E-04	1.0E-04	3.0E-04
Beryllium	2.2E-06	1.2E-06	3.3E-06
BOD	0.34	0.089	0.43
Boron	5.5E-04	3.1E-04	8.6E-04
Bromide	0.023	0.012	0.034
Cadmium	5.3E-06	3.7E-06	9.0E-06
Calcium	0.37	0.20	0.57
Chlorides (methyl chloride)	3.4E-09	2.5E-09	5.9E-09
Chlorides (unspecified)	0	2.49	2.49
Chromium (unspecified)	4.4E-04	2.4E-04	6.8E-04
Cobalt	3.9E-06	2.2E-06	6.1E-06
COD	0.58	0.028	0.61
Copper	4.9E-05	4.1E-05	9.0E-05
Cresols	1.1E-05	6.0E-06	1.6E-05
Cyanide	1.0E-06	4.5E-09	1.0E-06
Cymene	8.4E-09	6.3E-09	1.5E-08
Dibenzofuran	1.6E-08	1.2E-08	2.8E-08
Dibenzothiophene	1.3E-08	9.7E-09	2.3E-08
Dissolved Solids	32.6	2.49	35.1
Ethylbenzene	1.2E-05	5.8E-06	1.8E-05
Fluorine/Fluorides	9.0E-07	8.6E-04	8.6E-04
Hydrocarbons	0	2.0E-05	2.0E-05
Iron	0.030	0.021	0.051
Lead	9.1E-05	5.2E-05	1.4E-04
Lithium	0.058	0.052	0.11
Magnesium	0.074	0.040	0.11
Manganese	1.1E-04	0.0013	0.0014
Mercury	4.2E-07	1.2E-07	5.4E-07
Methyl Ethyl Ketone (MEK)	6.7E-09	5.1E-09	1.2E-08
Molybdenum	4.0E-06	2.3E-06	6.3E-06

Table 13-6  
 Waterborne Emissions for the Production of MDI  
 (lb per 1,000 lb or kg per 1,000 kg)  
 (page 2 of 2)

	Process emissions	Fuel-related emissions	Total emissions
Naphthalene	3.2E-06	1.8E-06	5.0E-06
Nickel	5.2E-05	2.3E-05	7.4E-05
Nitrates	1.0E-08	1.3E-04	1.3E-04
Nitrogen (ammonia)	0	4.6E-05	4.6E-05
Oil	0.029	0.0024	0.031
Pentamethyl benzene	6.3E-09	4.7E-09	1.1E-08
Phenanthrene	1.4E-07	8.0E-08	2.2E-07
Phenol/Phenolic Compounds	3.7E-04	4.1E-05	4.1E-04
Radionuclides (unspecified) (1)	0	9.4E-08	9.4E-08
Selenium	2.5E-06	2.0E-05	2.2E-05
Silver	2.3E-04	1.2E-04	3.5E-04
Sodium	1.07	0.57	1.64
Strontium	0.0096	0.0054	0.015
Sulfates	0.0077	0.090	0.098
Sulfides	4.9E-04	9.6E-06	5.0E-04
Sulfur	4.4E-04	2.5E-04	6.9E-04
Surfactants	9.0E-05	4.9E-05	1.4E-04
Suspended Solids	1.87	1.03	2.90
Thallium	2.2E-06	1.2E-06	3.4E-06
Tin	4.1E-05	2.3E-05	6.3E-05
Titanium	1.6E-04	8.7E-05	2.4E-04
Toluene	1.9E-04	9.5E-05	2.9E-04
Total Alkalinity	0.0083	0.0044	0.013
Total Biphenyls	2.2E-06	1.2E-06	3.4E-06
Total Dibenzo-thiophenes	6.7E-09	3.7E-09	1.0E-08
Vanadium	2.3E-05	5.4E-06	2.9E-05
Xylenes	9.3E-05	5.0E-05	1.4E-04
Yttrium	1.2E-06	6.7E-07	1.9E-06
Zinc	3.7E-04	2.3E-04	6.0E-04
Chloroform	1.0E-06	0	1.0E-06
Lead 210	1.8E-14	0	1.8E-14
n-Decane	5.1E-06	0	5.1E-06
n-Docosane	9.0E-08	0	9.0E-08
n-Dodecane	9.7E-06	0	9.7E-06
n-Eicosane	2.7E-06	0	2.7E-06
n-Hexacosane	5.6E-08	0	5.6E-08
n-Hexadecane	1.1E-05	0	1.1E-05
n-Octadecane	2.6E-06	0	2.6E-06
Phosphates	0.0071	0	0.0071
Radium 226	6.4E-12	0	6.4E-12
Radium 228	3.3E-14	0	3.3E-14
Styrene	1.4E-07	0	1.4E-07
TOC	0.025	0	0.025

(1) The units for Radionuclides are Curies per 1,000 lbs of product. The total Radionuclides using metric units are 7.66 kBq per 1,000 kgs of product.

Source: Franklin Associates, A Division of ERG

## CHAPTER 14

### CRADLE-TO-PRECURSOR LIFE CYCLE INVENTORY RESULTS FOR TDI

This chapter presents LCI results for the production of toluene diisocyanate (TDI) (cradle-to-TDI). The results are given on the bases of 1,000 pounds and 1,000 kilograms of TDI. Figure 14-1 presents the flow diagram for the production of TDI. Process descriptions and individual process tables for each box shown in the flow diagram can be found in Appendix N of the Appendices (separate document).

Primary data was collected for chlorine/caustic soda and DNT/phosgene/TDA/TDI production. The chlorine/caustic data collected for this module represent 1 producer and 3 plants in the U.S. Besides this recently collected data, 2 diaphragm cell datasets and 2 mercury cell datasets were used from the early 1990s. For this analysis, it is estimated that 91.4 percent of the cell technology is diaphragm and membrane, while 8.6 percent of the cell technology is mercury. The collected datasets were weighted using these fractions. As of 2003 there were 20 chlorine/caustic producers and 41 chlorine/caustic plants in the U.S. for the three standard technologies. The captured production amount is approximately 30 percent of the available capacity for all chlorine production in the U.S. Caustic soda and hydrogen are the coproducts produced with chlorine. A mass basis was used to allocate the credit to the coproducts.

A weighted average using production amounts was calculated from the DNT/phosgene/TDA/TDI production data from three plants collected from three leading producers in North America. As of 2002, there were 5 TDI producers and 6 TDI plants in the U.S. The captured production amount is approximately 55 percent of the available capacity for TDI production in the U.S. and Canada. Hydrogen chloride and exported steam/heat are produced as coproducts during this process. A mass basis was used to allocate the credit for hydrogen chloride. The energy for exported steam/heat was reported separately as recovered energy.

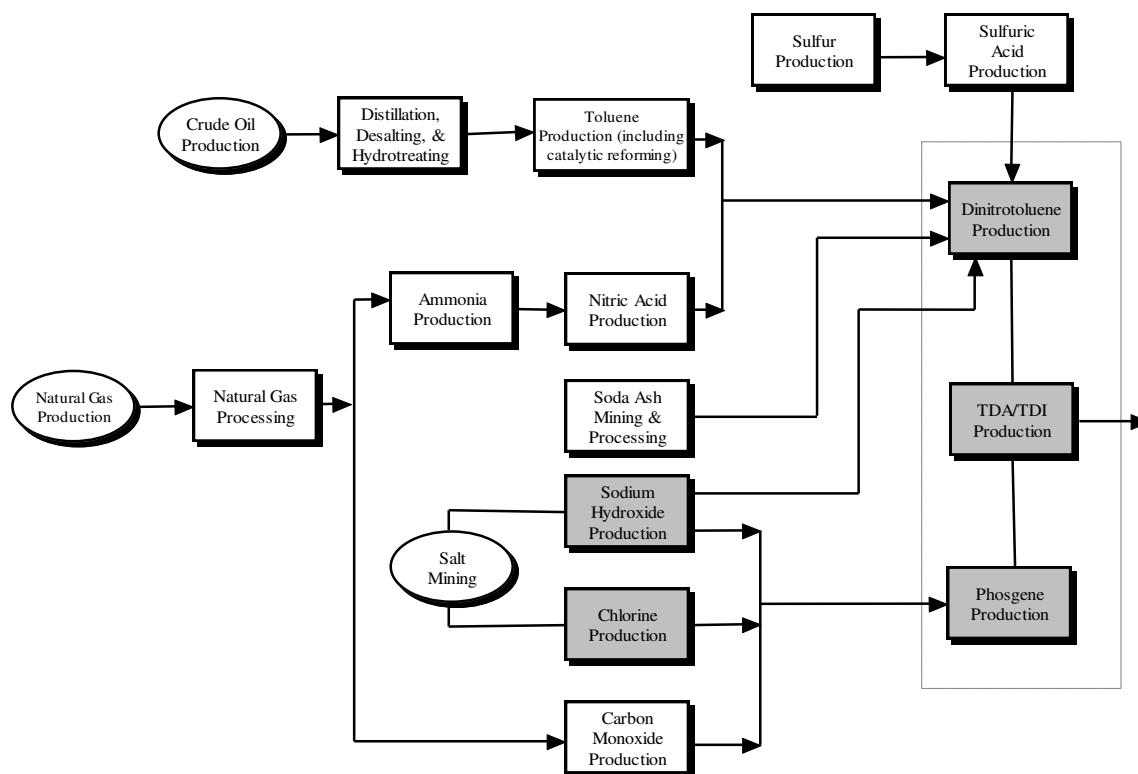

Figure 14-1. Flow diagram for the manufacture of toluene diisocyanate (TDI). Shaded boxes represent partial or complete data provided by manufacturers specifically for this analysis. Boxes within the dotted rectangle are included in an aggregate dataset.

## DESCRIPTION OF TABLES

The average gross energy required to produce TDI is 22.3 million Btu per 1,000 pounds or 51.8 GJ per 1,000 kilograms. Tables 14-1 and 14-2 show the breakdown of energy requirements for the production of TDI by category and source, respectively. Precombustion energy (the energy used to extract and process fuels used for process energy and transportation energy) is included in the results shown in these tables. Table N-1 in the Appendices (separate document) provides the aggregated unit process energy (cradle-to-TDI) for the production of TDI. Natural gas and petroleum used as raw material inputs for the production of TDI, reported as energy of material resource in Table 14-1, are included in the totals for natural gas and petroleum energy in Table 14-2. Petroleum-based fuels (e.g. diesel fuel) are the dominant energy source for transportation. Non-fossil sources, such as hydropower, nuclear and other (geothermal, wind, etc.) shown in Table 14-2 are used to generate purchased electricity along with the fossil fuels.



Table 14-1

## Energy by Category for the Production of TDI

Energy Category	MMBtu per 1,000 pounds	GJ per 1,000 kilograms
Process (1)	12.4	28.8
Transportation	0.45	1.05
Energy of Material Resource	9.44	21.9
<b>Total Energy</b>	<b>22.3</b>	<b>51.8</b>
<b>Energy Category (Percent)</b>		
Process	56%	56%
Transportation	2%	2%
Energy of Material Resource	42%	42%
<b>Total</b>	<b>100%</b>	<b>100%</b>

(1) Process energy includes recovered energy, which is shown as a credit.

Source: Franklin Associates, A Division of ERG

Table 14-2

## Energy Profile for the Production of TDI

Energy Source	MM Btu per 1,000 pounds	GJ per 1,000 kilograms
Natural Gas	13.0	30.2
Petroleum	7.03	16.4
Coal	1.82	4.22
Hydropower	0.070	0.16
Nuclear	0.60	1.39
Wood	0.0078	0.018
Other	0.11	0.25
<b>Recovered Energy (1)</b>	<b>-0.35</b>	<b>-0.82</b>
<b>Total Energy</b>	<b>22.3</b>	<b>51.8</b>
<b>Energy Source (Percent)</b>		
Natural Gas	57%	57%
Petroleum	31%	31%
Coal	8%	8%
Hydropower	0%	0%
Nuclear	3%	3%
Wood	0%	0%
Other	0%	0%
<b>Total</b>	<b>100%</b>	<b>100%</b>

(1) Recovered energy represents the recovery of energy as steam or condensate. Because this energy will be used by other processes, it is shown as a negative entry (credit).

Source: Franklin Associates, A Division of ERG

Table 14-3 shows the weight of solid waste generated during the production of TDI. The total generated solid waste includes wastes that are incinerated both for disposal and for waste-to-energy, as well as landfilled. These categories have been provided separately.

Both process and fuel-related, as well as total, atmospheric emissions are shown in Table 14-4. As defined in the report glossary, process emissions are those released directly from the sequence of processes that are used to extract, transform, fabricate, or otherwise affect changes on a material or product during its life cycle, while fuel-related emissions are those associated with the combustion of fuels used for process energy and transportation energy.

Table 14-3

## Solid Wastes by Weight for the Production of TDI

	<u>lb per 1,000 pounds</u>	<u>kg per 1,000 kilograms</u>
<b>Solid Wastes By Weight</b>		
Process		
Landfilled	15.1	15.1
Incinerated	1.34	1.34
Waste-to-Energy	34.3	34.3
Fuel	<u>72.6</u>	<u>72.6</u>
<b>Total</b>	<b>123</b>	<b>123</b>
<b>Weight Percent by Category</b>		
Process		
Landfilled	12%	12%
Incinerated	1%	1%
Waste-to-Energy	28%	28%
Fuel	<u>59%</u>	<u>59%</u>
<b>Total</b>	<b>100%</b>	<b>100%</b>

Source: Franklin Associates, A Division of ERG

Table 14-4  
**Atmospheric Emissions for the Production of TDI**  
 (lb per 1,000 lb or kg per 1,000 kg)  
 (page 1 of 2)

	Process emissions	Fuel-related emissions	Total emissions
<b>Atmospheric Emissions</b>			
Carbon Dioxide - Fossil	41.1	1,799	1,840
Methane	2.57	7.60	10.2
Nitrous Oxide	0	0.040	0.040
Carbon Dioxide - Non-Fossil	0	7.12	7.12
Particulates (unspecified)	0.41	0.31	0.72
Particulates (PM10)	0.030	0.26	0.29
Particulates (PM2.5)	0.0082	0.16	0.16
Nitrogen Oxides	0.60	3.75	4.35
Sulfur Dioxide	0.39	3.55	3.94
Sulfur Oxides	0.16	1.17	1.33
VOC (unspecified)	0.13	0.44	0.57
TNMOC (unspecified)	0.81	0.012	0.82
Hydrocarbons (unspecified)	0	0.040	0.040
Carbon Monoxide	1.61	1.12	2.73
1,3 Butadiene	0	5.9E-07	5.9E-07
2,4-Dinitrotoluene	0	2.5E-09	2.5E-09
2-Chloroacetophenone	0	6.2E-08	6.2E-08
5-Methyl Chrysene	0	2.0E-09	2.0E-09
Acenaphthene	0	4.7E-08	4.7E-08
Acenaphthylene	0	2.3E-08	2.3E-08
Acetophenone	0	1.3E-07	1.3E-07
acrolein	0	1.7E-04	1.7E-04
Aldehydes (Acetaldehyde)	0	5.3E-05	5.3E-05
Aldehydes (Formaldehyde)	0	0.0012	0.0012
Aldehydes (Propionaldehyde)	0	3.4E-06	3.4E-06
Aldehydes (unspecified)	2.4E-04	8.0E-05	3.2E-04
Ammonia	0.39	2.2E-04	0.39
Ammonia Chloride	0	6.0E-05	6.0E-05
Anthracene	0	1.9E-08	1.9E-08
Antimony	6.3E-07	2.1E-06	2.7E-06
Arsenic	8.0E-08	4.5E-05	4.5E-05
Benzene	0.016	0.042	0.058
Benzo(a)anthracene	0	7.4E-09	7.4E-09
Benzo(a)pyrene	0	3.5E-09	3.5E-09
Benzo(b,j,k)fluoranthene	0	1.0E-08	1.0E-08
Benzo(g,h,i) perylene	0	2.5E-09	2.5E-09
Benzyl Chloride	0	6.2E-06	6.2E-06
Beryllium	0	2.6E-06	2.6E-06
Biphenyl	0	1.6E-07	1.6E-07
Bis(2-ethylhexyl) Phthalate (DEHP)	0	6.4E-07	6.4E-07
Bromoform	0	3.4E-07	3.4E-07
Cadmium	0	1.7E-05	1.7E-05
Carbon Disulfide	0	1.1E-06	1.1E-06
Carbon Tetrachloride	8.8E-05	1.7E-06	8.9E-05
CFC 13 (Methane, trichlorofluoro-)	6.8E-06	1.2E-06	8.0E-06
Chlorobenzene	0	1.9E-07	1.9E-07
Chloroform	0	5.2E-07	5.2E-07
Chlorine	8.1E-04	2.9E-05	8.4E-04
Chromium	2.1E-07	4.1E-05	4.1E-05
Chromium (VI)	0.0E+00	7.3E-06	7.3E-06
Chrysene	0.0E+00	9.2E-09	9.2E-09
Cobalt	0.0E+00	3.4E-05	3.4E-05

Table 14-4

**Atmospheric Emissions for the Production of TDI**  
**(lb per 1,000 lb or kg per 1,000 kg)**  
 (page 2 of 2)

	Process emissions	Fuel-related emissions	Total emissions
Copper	0	8.7E-07	8.7E-07
Cumene	0	4.7E-08	4.7E-08
Cyanide	0	2.2E-05	2.2E-05
Dimethyl Sulfate	0	4.2E-07	4.2E-07
Dioxins (unspecified)	0	6.1E-08	6.1E-08
Ethyl Chloride	0	3.7E-07	3.7E-07
Ethylbenzene	0.0019	0.0049	0.0068
Ethylene Dibromide	1.3E-06	2.5E-07	1.6E-06
Ethylene Dichloride	0	3.5E-07	3.5E-07
Fluoranthene	0	6.6E-08	6.6E-08
Fluorene	0	8.4E-08	8.4E-08
Fluorides	0	4.0E-04	4.0E-04
Furans (unspecified)	0	2.1E-10	2.1E-10
Hydrogen Chloride	0.0011	0.11	0.11
Hexane	0	5.9E-07	5.9E-07
Hydrogen Fluoride	0	0.013	0.013
Indeno(1,2,3-cd)pyrene	0	5.6E-09	5.6E-09
Isophorone (C <sub>9</sub> H <sub>14</sub> O)	0	5.1E-06	5.1E-06
Kerosene	0	1.1E-04	1.1E-04
Lead	1.0E-07	8.0E-05	8.1E-05
Magnesium	0	0.0010	0.0010
Manganese	0	1.2E-04	1.2E-04
Mercaptan	0	0.0019	0.0019
Mercury	7.8E-05	2.2E-05	9.9E-05
Metals (unspecified)	0	0.0016	0.0016
Methyl Bromide	0	1.4E-06	1.4E-06
Methyl Chloride	0	4.7E-06	4.7E-06
Methyl Ethyl Ketone	0	3.4E-06	3.4E-06
Methyl Hydrazine	0	1.5E-06	1.5E-06
Methyl Methacrylate	0	1.8E-07	1.8E-07
Methyl Tert Butyl Ether (MTBE)	0	3.1E-07	3.1E-07
Methylene Chloride	0	6.2E-05	6.2E-05
Naphthalene	0	1.5E-05	1.5E-05
Nickel	1.8E-06	3.8E-04	3.8E-04
Organics (unspecified)	0.13	5.1E-04	0.13
Perchloroethylene	0	4.3E-06	4.3E-06
Phenanthrene	0	2.5E-07	2.5E-07
Phenols	0	2.1E-05	2.1E-05
Polyaromatic Hydrocarbons (total)	1.7E-05	7.7E-06	2.5E-05
Propylene	0	3.9E-05	3.9E-05
Pyrene	0	3.0E-08	3.0E-08
Radionuclides (unspecified) (1)	0	0.0061	0.0061
Selenium	0	1.3E-04	1.3E-04
Styrene	0	2.2E-07	2.2E-07
Toluene	0.025	0.063	0.087
Trichloroethane	0	1.8E-07	1.8E-07
Vinyl Acetate	0	6.7E-08	6.7E-08
Xylenes	0.014	0.037	0.051
Zinc	0	5.8E-07	5.8E-07
HCFC-123	4.1E-05	0	4.1E-05
HCFC-22	0.010	0	0.010
HFC-134a	4.1E-05	0	4.1E-05
NMVOC, non-methane volatile organic compounds, unspecified origin	0.21	0	0.21
Non-Methane Hydrocarbons	0.024	0	0.024
ODCB (air)	0.0010	0	0.0010
Phosgene	1.0E-05	0	1.0E-05
TDA	1.0E-05	0	1.0E-05
TDI	1.0E-04	0	1.0E-04

(1) The units for Radionuclides are Curies per 1,000 lbs of product. The total Radionuclides using metric units are 498,500 kBq per 1,000 kgs of product.

Source: Franklin Associates, A Division of ERG

Table 14-5 provides a greenhouse gas (GHG) summary for the production of TDI. The primary three atmospheric emissions reported in this analysis that contribute to global warming are fossil fuel-derived carbon dioxide, methane, and nitrous oxide. (Non-fossil carbon dioxide emissions, such as those from the burning of wood, are considered part of the natural carbon cycle and are not considered a net contributor to global warming.) The 100-year global warming potential for each of these substances as reported in the Intergovernmental Panel on Climate Change (IPCC) 2007 report are shown in a note at the bottom of Table 14-5. The global warming potential represents the relative global warming contribution of a pound of a particular greenhouse gas compared to a pound of carbon dioxide. The weights of each of the contributing emissions in Table 14-4 are multiplied by their global warming potential and shown in Table 14-5.

Both process and fuel-related, as well as the total waterborne emissions are shown in Table 14-6. Definitions of process and fuel-related emissions are earlier previously in this chapter, as well as in the glossary.

Table 14-5

**Greenhouse Gas Summary for the Production of TDI**  
(lb carbon dioxide equivalents per 1,000 lb TDI or kg carbon dioxide equivalents per 1,000 kg TDI)

	<u>Fuel-related CO2 Equiv.</u>	<u>Process CO2 Equiv.</u>	<u>Total CO2 Equiv.</u>
Carbon Dioxide - Fossil	1,799	41.1	1,840
Methane	190	64.1	254
Nitrous Oxide	11.8	0	11.8
Methyl Bromide	7.1E-06	0	7.1E-06
Methyl Chloride	7.5E-05	0	7.5E-05
Trichloroethane	2.5E-05	0	2.5E-05
Chloroform	1.6E-05	0	1.6E-05
Methylene Chloride	6.2E-04	0	6.2E-04
Carbon Tetrachloride	0.0024	0.12	0.13
CFC 13 (Methane, trichlorofluor	0.015	0.079	0.094
HCFC-123	0	0.0032	0.0032
HCFC-22	0	18.1	18.1
HFC-134a	0	0.059	0.059
Total	<u>2,001</u>	<u>105</u>	<u>2,107</u>

Note: The 100 year global warming potentials used in this table are as follows: fossil carbon dioxide--1, methane--25, nitrous oxide--298, methyl bromide--5, methyl chloride--16, trichloroethane--140, chloroform--30, methylene chloride--10, carbon tetrachloride--1400, CFC-013--11,700, HCFC-22--1810, HCFC-123--77, and HFC-134a--1430.

Source: Franklin Associates, A Division of ERG

**Table 14-6**  
**Waterborne Emissions for the Production of TDI**  
**(lb per 1,000 lb or kg per 1,000 kg)**  
**(page 1 of 2)**

	Process emissions	Fuel-related emissions	Total emissions
<b>Waterborne Wastes</b>			
1-methylfluorene	5.0E-09	8.8E-09	1.4E-08
2,4 dimethylphenol	3.1E-06	3.4E-06	6.5E-06
2-Hexanone	7.3E-07	7.9E-07	1.5E-06
2-methyl naphthalene	1.7E-06	1.9E-06	3.6E-06
4-methyl-2-pentanone	1.8E-07	3.2E-07	5.1E-07
Acetone	4.4E-07	7.7E-07	1.2E-06
Acid (benzoic)	1.1E-04	1.2E-04	2.4E-04
Acid (hexanoic)	2.4E-05	2.5E-05	4.9E-05
Acid (unspecified)	0.0025	0	0.0025
Alkylated Benzenes	2.1E-05	2.3E-05	4.4E-05
Alkylated Fluorenes	1.2E-06	1.3E-06	2.5E-06
Alkylated Naphthalenes	3.5E-07	3.7E-07	7.2E-07
Alkylated Phenanthrenes	1.5E-07	1.5E-07	3.0E-07
Aluminum	0.010	0.011	0.022
Ammonia	0.034	0.0021	0.036
Ammonium	0	4.8E-05	4.8E-05
Antimony	6.6E-06	6.9E-06	1.3E-05
Arsenic	2.3E-05	2.4E-05	4.6E-05
Barium	0.14	0.15	0.29
Benzene	1.3E-04	1.3E-04	2.5E-04
Beryllium	1.4E-06	1.4E-06	2.8E-06
BOD	0.42	0.085	0.50
Boron	3.5E-04	3.8E-04	7.3E-04
Bromide	0.015	0.014	0.029
Cadmium	3.5E-06	4.3E-06	7.7E-06
Calcium	0.24	0.24	0.49
Chlorides (methyl chloride)	1.8E-09	3.1E-09	4.8E-09
Chlorides (unspecified)	0	3.02	3.02
Chromium (unspecified)	2.8E-04	2.9E-04	5.8E-04
Cobalt	2.5E-06	2.7E-06	5.2E-06
COD	0.62	0.033	0.66
Copper	3.2E-05	4.6E-05	7.7E-05
Cresols	6.7E-06	7.2E-06	1.4E-05
Cyanide	3.0E-05	5.6E-09	3.0E-05
Cymene	4.4E-09	7.7E-09	1.2E-08
Dibenzofuran	8.3E-09	1.5E-08	2.3E-08
Dibenzothiophene	6.7E-09	1.2E-08	1.9E-08
Dissolved Solids	24.0	3.01	27.0
Ethylbenzene	7.0E-06	7.0E-06	1.4E-05
Fluorine/Fluorides	5.8E-07	7.9E-04	7.9E-04
Hydrocarbons	0	2.4E-05	2.4E-05
Iron	0.020	0.024	0.044
Lead	5.9E-05	6.2E-05	1.2E-04
Lithium	0.025	0.064	0.089
Magnesium	0.048	0.049	0.097
Manganese	7.0E-05	0.0013	0.0013
Mercury	3.8E-07	1.4E-07	5.2E-07
Methyl Ethyl Ketone (MEK)	3.5E-09	6.2E-09	9.7E-09
Molybdenum	2.6E-06	2.8E-06	5.4E-06

**Table 14-6**  
**Waterborne Emissions for the Production of TDI**  
**(lb per 1,000 lb or kg per 1,000 kg)**  
**(page 2 of 2)**

	Process emissions	Fuel-related emissions	Total emissions
Naphthalene	2.0E-06	2.2E-06	4.2E-06
Nickel	2.8E-05	2.8E-05	5.6E-05
Nitrates	0.027	1.2E-04	0.027
Nitrogen (ammonia)	0	4.2E-05	4.2E-05
Oil	0.017	0.0028	0.020
Pentamethyl benzene	3.3E-09	5.8E-09	9.0E-09
Phenanthrene	9.0E-08	9.7E-08	1.9E-07
Phenol/Phenolic Compounds	1.1E-04	4.8E-05	1.5E-04
Radionuclides (unspecified) (1)	0	8.5E-08	8.5E-08
Selenium	1.8E-06	1.8E-05	2.0E-05
Silver	1.5E-04	1.5E-04	2.9E-04
Sodium	0.70	0.69	1.39
Strontium	0.0061	0.0066	0.013
Sulfates	0.0050	0.084	0.089
Sulfides	0.0011	1.1E-05	0.0011
Sulfur	2.7E-04	3.0E-04	5.8E-04
Surfactants	5.9E-05	5.9E-05	1.2E-04
Suspended Solids	1.25	1.24	2.49
Thallium	1.4E-06	1.5E-06	2.8E-06
Tin	2.6E-05	2.7E-05	5.3E-05
Titanium	1.0E-04	1.1E-04	2.1E-04
Toluene	1.2E-04	1.2E-04	2.3E-04
Total Alkalinity	0.0055	0.0054	0.011
Total Biphenyls	1.4E-06	1.5E-06	2.8E-06
Total Dibenzo-thiophenes	4.3E-09	4.5E-09	8.8E-09
Vanadium	2.0E-05	6.3E-06	2.6E-05
Xylenes	6.1E-05	6.0E-05	1.2E-04
Yttrium	7.5E-07	8.1E-07	1.6E-06
Zinc	2.4E-04	2.7E-04	5.1E-04
Chloroform	1.0E-06	0	1.0E-06
Lead 210	1.2E-14	0	1.2E-14
n-Decane	3.3E-06	0	3.3E-06
n-Docosane	4.7E-08	0	4.7E-08
n-Dodecane	6.2E-06	0	6.2E-06
n-Eicosane	1.7E-06	0	1.7E-06
n-Hexacosane	2.9E-08	0	2.9E-08
n-Hexadecane	6.7E-06	0	6.7E-06
n-Octadecane	1.7E-06	0	1.7E-06
ODCB (water)	1.0E-04	0	1.0E-04
Phosphates	0.0010	0	0.0010
Radium 226	4.1E-12	0	4.1E-12
Radium 228	2.1E-14	0	2.1E-14
Sodium Hydroxide	1.00	0	1.00
Tetradecane	2.6E-06	0	2.6E-06
TOC	0.010	0	0.010

(1) The units for Radionuclides are Curies per 1,000 lbs of product. The total Radionuclides using metric units are 6.97 kBq per 1,000 kgs of product.

Source: Franklin Associates, A Division of ERG

**ADDENDUM****DIFFERENCES BETWEEN THE U.S. LCI PLASTICS DATABASE  
AND THE PLASTICSEUROPE ECO-PROFILES DATABASE****INTRODUCTION**

This addendum presents the differences between the U.S. LCI Plastics Database and the PlasticsEurope Eco-Profiles Database. The original purpose of this comparison was to highlight and reconcile the original differences between these two separate databases before the public release of the revised U.S. plastics data into the U.S. LCI Database project. Energy and total greenhouse gases (CO<sub>2</sub> equivalents) for each comparable plastic resin and polyurethane precursor in the 2011 report were analyzed in the comparison. After the energy differences were identified in the 2006 draft version of this report, Ian Boustead of Boustead Consulting, Ltd. was contacted by Franklin Associates staff to discuss the differences in results for the two databases. The following sections discuss specific areas where differences were identified between the U.S. and European plastics databases.

The current results have not been reviewed by PlasticsEurope consultants. Both the 2007 and 2011 results for the U.S. LCI Plastics Database have been included in the following tables. Differences between the two sets of results are due to three major factors: (a) intermediate data collection/replacement, (b) a change in the methodology used for handling fuels produced within the production of a number of intermediate chemicals (including the hydrocracker), and (c) an update of the oil extraction and refining and natural gas extraction and processing. The methodology change is consistent with a harmonization of LCA methodologies collaboration that both PlasticsEurope and ACC have undertaken, with a goal of providing a global synchronization of methodologies to conduct polymer LCAs consistent with the ISO 14040 series of standards.

Intermediate results were released in 2010. These results were prior to the release of the data to NREL. During the intensive review process of submitting the data to NREL, some changes were made to the datasets. Some were small changes in one or two emissions for a dataset; while others were larger changes which affected the total cradle-to-resin results for some of the plastics. The oil and natural gas update was completed in 2011. A list of differences between this report and the previous report can be found after the conclusion of this Addendum.



## OVERVIEW OF COMPARISON OF PLASTICS AND PRECURSOR ENERGY AND GREENHOUSE GAS RESULTS

### Energy Comparison

Table AD-1 presents the total energy for each comparable plastic resin and polyurethane precursor for the 2011 U.S. LCI Plastics Database, the 2007 U.S. LCI Plastics Database, and the current PlasticsEurope Eco-Profiles Database. That table also provides the energy difference between U.S. and European results, and the percent difference between U.S. and European results. The percent differences range from 1 percent to 10 percent for the plastic resins. The percent differences for the polyols (polyurethane precursors) are less meaningful. Polyols have been separated into polyols for rigid foam polyurethane and polyols for flexible foam polyurethane for the U.S. LCI Plastics Database. The PlasticsEurope Eco-Profiles Database does not specify what percentage of the polyols data is for rigid foam polyurethane and flexible foam polyurethane. Therefore, the actual percent difference is within the range of -11 to 3 percent.

One important fact to note is that the ranges of the energy results for the individual plants collected in Europe were large according to various EcoProfiles reports. Individual plant results varied as much as 25 percent on either side of the average total energy. Although individual facility results may be considerably below or above the average, they are part of the population that generated the reported average. The percent differences between the U.S. and European total energy averages shown in Table AD-1 are within the range of the individual plant total energy results in Europe. With greater participation by North American plastic producers, the total energy average for North American resins may increase or decrease. Given the variations in individual U.S. and European plant data, the U.S. 2011 resin averages, while different from the 2007 and European averages, are likely not *statistically* different.

The largest difference is found when the U.S. and European isocyanates data are compared. The U.S. isocyanates energy requirements are a little more than half that of the European isocyanates energy requirements. The isocyanates results were reviewed by Ian Boustead in 2006. Due to the large differences in energy results for the isocyanates between the two databases, it was decided that Franklin Associates would attempt to collect primary data for the intermediate chemicals to the isocyanates. New primary data was collected for formaldehyde and DNT. The overall difference in the new primary data with the previous data used was very small. The major issue contributing to the difference in U.S. and European results is the treatment of hydrochloric acid that is coproduced during the production of isocyanates. In the U.S., the hydrochloric acid is utilized as a coproduct, so the process burdens are allocated between the isocyanate output and the hydrochloric acid output on a mass basis. In the PlasticsEurope methodology, the hydrochloric acid was treated as a waste, so all the process burdens were allocated to the isocyanate output. During recent discussions with PlasticsEurope contacts, it was discovered that a number of European isocyanate plants are selling the hydrochloric acid. PlasticsEurope is in discussions with ISOPA to update the European

isocyanates data to reflect the use of hydrochloric acid as a coproduct, and an update based on mass allocation for HCl as a coproduct is expected to make the US and European isocyanates values similar. Other differences include methodology differences between the Franklin Associates and Boustead models for feedstock energy/EMR and precombustion energy.

Table AD-1

Total Energy Comparison of ACC Plastics LCI Database and PlasticsEurope Plastics LCI Database  
(MJ per 1 kg of resin/precursor)

	2011 ACC Database	2007 final ACC Database	PlasticsEurope Database	2007 Difference*		2011 Difference*	
HDPE	78.3	68.9	76.7	-7.8	-11%	1.6	2%
LDPE	83.6	74.0	78.1	-4.1	-5%	5.5	7%
LLDPE	78.0	68.5	72.7	-4.2	-6%	5.3	7%
PP	77.0	63.4	73.4	-10.0	-15%	3.6	5%
PET	70.4	69.1	69.4	-0.3	0%	1.0	1%
GPPS	95.1	84.6	86.5	-1.9	-2%	8.6	10%
HIPS	96.1	85.6	87.4	-1.8	-2%	8.7	9%
PVC	59.2	52.4	56.7	-4.3	-8%	2.5	4%
ABS	105	93.3	95.3	-2.0	-2%	9.7	10%
Polyol--Rigid Polyurethane	83.1	74.3	93.2	-18.9	-23%	-10.1	-11%
Polyol--Flexible Polyurethane	95.7	85.2	93.2	-8.0	-9%	2.5	3%
MDI	59.8	NA	91.0	NA	NA	-31.2	-41%
TDI	51.8	NA	108.2	NA	NA	-56.4	-71%

Note: Polyols are one category in the PlasticsEurope database

\* Difference = ACC energy - PlasticsEurope energy  
% difference = (difference between ACC and PE results)/(average of ACC and PE results)

Updated with August 2011 ACC DB & EcoProfiles as of August 2011

In reviewing the discussion of energy differences, it is useful to understand the terminology used by the consultants in reporting energy results. There are four categories of energy used by Franklin Associates and Boustead Consulting. Within these four categories, there are differences in terminology between the U.S. and European plastics databases. Table AD-2 lists and defines the energy categories.

Table AD-2

## Energy Categories: Terminology and Definition

U.S. Terminology	European Terminology
<b>Process Energy</b> --Energy used for any/all processes that extract, transform, fabricate or otherwise effect changes on a material or product	<b>Energy Content of Delivered Fuel</b> --the energy that is received by the final operator who consumes energy
<b>Transportation Energy</b> --the energy used to move materials or products from location to location during the journey from raw material extraction through end of life disposition [note: the resin database boundaries end at the resin production step]	<b>Transport Energy</b> --the energy associated with fuels consumed directly by the transport operations as well as any energy associated with the production of non-fuel bearing materials, such as steel, that are taken into the transport process.
<b>Energy of Material Resource</b> --the energy value of fuel resources withdrawn from the planet's finite fossil reserves and used as inputs for materials such as plastic resins	<b>Feedstock Energy</b> --the energy of the fuel bearing materials that are taken into the system but used as materials rather than fuels
<b>Precombustion Energy</b> --the energy required for the production and processing of energy fuels, starting with their extraction from the ground, up to the point of delivery to the customer	<b>Fuel Production and Delivery Energy</b> --the energy that is used by the fuel producing industries in extracting the primary fuel from the earth, processing it and delivering it to the ultimate consumer

## Greenhouse Gas Comparison

Table AD-3 provides the total greenhouse gases (CO<sub>2</sub> equivalents) for each comparable plastic resin and polyurethane precursor for the 2011 U.S. LCI Plastics Database, the 2007 U.S. LCI Plastics Database, and the current PlasticsEurope Eco-Profiles Database. That table also provides the CO<sub>2</sub> equivalents difference between U.S. and European results, and the percent difference between U.S. and European results. The greenhouse gases percent differences range from -6 percent to 25 percent for the plastic resins. The results for polyols are also within that range of percent differences. This increase in greenhouse gas is mostly due to the inclusion of fugitive emissions from pipelines, which was previously not included. It is unknown if these fugitive emissions are included in the PlasticsEurope Database. The percent difference results for the isocyanates follow the percent differences of energy.

The greenhouse gas results were not compared with the European results in 2006. Besides the introduction of pipeline fugitive emissions, another difference may lie in the hydrocracker results. It is unknown if the European Eco-Profiles include greenhouse gases released from the combustion of the offgas used within the hydrocrackers. Franklin Associates did take this into account using the plant data collected. Other differences lie within the fuel profiles of the industries and countries considered. Depending on what fuels are available and least expensive, companies within an industry may use a number of possible fuels, which have differing greenhouse gas potentials.

## DATA SOURCES

All primary data for the U.S. plastics LCI database were collected between 2003 and 2005. These data represent the year 2003 for the most part. One exception is the formaldehyde data, which represents 2007 data. Franklin Associates and ACC were diligent in finding at least three companies to participate in collecting data for each resin and precursor studied. However, in some cases, there were fewer numbers of companies participating due to confidentiality concerns and issues for U.S. companies. The data collection effort focused on the resin production step, as well as intermediate chemicals that the resin producers manufactured.

Table AD-3

Total CO2 Equivalent Comparison of ACC Plastics LCI Database and PlasticsEurope Plastics LCI Database  
(kg CO2 equivalents per 1 kg of resin/precursor)

	2011 ACC Database**	2007 final ACC Database	PlasticsEurope Database	2007 Difference*		2010 Difference*	
HDPE	1.897	1.478	1.930	-0.452	-27%	-0.033	-2%
LDPE	2.201	1.477	2.080	-0.603	-34%	0.121	6%
LLDPE	1.901	1.479	1.824	-0.345	-21%	0.077	4%
PP	1.860	1.343	1.964	-0.621	-38%	-0.104	-5%
PET	2.733	2.538	2.150	0.388	17%	0.583	24%
GPPS	3.242	2.763	3.432	-0.669	-22%	-0.190	-6%
HIPS	3.259	2.757	3.424	-0.667	-22%	-0.165	-5%
PVC	2.419	2.029	1.889	0.140	7%	0.530	25%
ABS	3.805	3.149	3.760	-0.611	-18%	0.045	1%
Polyol--Rigid Polyurethane	3.718	3.377	3.547	-0.170	-5%	0.171	5%
Polyol--Flexible Polyurethane	4.035	3.633	3.547	0.086	2%	0.488	13%
MDI	2.377	NA	3.947	NA	NA	-1.570	-50%
TDI	2.107	NA	6.264	NA	NA	-4.157	-99%

Note: Polyols are one category in the PlasticsEurope database

- \* Difference = ACC CO2 - PlasticsEurope CO2  
% difference = (difference between ACC and PE results)/(average of ACC and PE results)  
\*\* 2011 Numbers are reported with updated global warming potentials

Updated with August 2011 ACC DB & EcoProfiles as of August 2011

Boustead Consulting collected and updated various plastic Eco-Profiles for PlasticsEurope for over 15 years. Boustead Consulting, in most cases, received a significant response by most of the European plastics industry in providing datasets for resin production as well as the upstream unit processes. At this time, much of the intermediates and ancillary materials used in the polymer production of the European plastics LCI database are primary datasets.

Another difference between the data sources of these two databases is the fuel data. The fuels information for the European database is based on statistics published by the International Energy Agency (IEA). Country specific fuel data is used for each primary dataset. Fuel production data for the U.S. were based on Department of Energy national statistics and data. The national average U.S. electricity grid (from the U.S. LCI Database) was used.

Other data source differences include:

- Transportation differences. Distances for some transportation steps are higher in North America compared to Europe.
- Different feedstock mixes. Differences in the mix of crude oil and natural gas used as resin material feedstocks in the U.S. and in Europe lead to different feedstock energy (energy of material resource). This comes about due to the difference in calorific values for natural gas (54 MJ/kg) and crude oil (45 MJ/kg).
- Different material sources. Differences in the source of an intermediate chemical/material may make a difference in raw materials, energy, and/or emissions. One example is the glycerine used in the polyols used in flexible foam polyurethane. It may be produced from a number of sources, including palm oil, animal fat, and from propylene.
- Accuracy/types of collected data. The collected U.S. data (including a few Canadian and Mexican plants) was taken from a variety of sources within each company providing data (ranging from estimates to calculations from utility records).
- Differences of the size and age of plants providing data. Production quantities were used to weight the provided data; therefore smaller plants were weighted lower than the larger plants.
- Differences in plant sites. Coproducts that may be regarded as wastes on a small site or stand-alone plant may be regarded as inputs to other processes on large sites.

- Differences in system boundaries. The European plastics LCI database includes waste incineration facilities within its system boundaries. No waste incineration facilities are included within the system boundaries of the U.S. plastics LCI database. Many U.S. plants had wastes sent to incineration facilities; however, these were commonly off-site and mixed with wastes from other plants, and so data were unavailable for the specific materials of interest. In some cases, large amounts of chemicals that were incinerated as wastes at European plants were actually coproducts (sold for profit) at corresponding U.S. plants.

## METHODOLOGICAL DIFFERENCES

**Averaging Data.** Using PlasticsEurope LCI terminology, horizontal and vertical averaging are two different methods of producing average data. A detailed description of each method is given in the PlasticsEurope Methodology pdf document found at <http://www.lca.plasticseurope.org/methodol.htm> under the heading “Calculating Averages”.

Based on Boustead Consulting’s description, Franklin Associates averages the primary data collected using the horizontal averaging method. Boustead Consulting uses the vertical averaging method for the primary data collected in Europe. Franklin Associates is not able to use the vertical method of averaging due to fewer data providers and the fact that much of the intermediate chemicals data used by Franklin Associates were unavailable from primary sources.

Figure AD-1 and AD-2 provide flow diagrams showing the use of horizontal and vertical averaging. Using these flow diagrams as an example, Figure AD-1 shows how this analysis utilized horizontal averaging to calculate averages for each unit process for which primary data was received, including intermediate materials and the final material. The average unit process datasets are then linked to calculate the average cradle-to-resin dataset. Figure AD-2 shows how vertical averaging, utilized by PlasticsEurope’s database, calculates averages after calculating a cradle-to-product dataset for each company and their supply chain.

Boustead Consulting and Franklin Associates agree that the vertical averaging is the most accurate method of calculating average primary data. However, this method requires that data be available for each resin producer’s complete supply chain. Figure AD-2 shows the difficulty that arises when complete supply chain data is not available. In this figure, Company C has provided ethylene data, but the resin producer that they supply to did not provide data for the analysis. Also, Company D provided LDPE resin data, but its supplier of ethylene did not provide data. This is the challenge that Franklin Associates faced as, in most cases, only a small percentage of companies within the specific material industry were participating, and even fewer companies provided intermediate chemical data. However, these limitations can be accommodated using horizontal averaging (see Figure AD-1). Company C’s data can be averaged into an industry-average ethylene dataset, and the same is true for Company D’s LDPE data.

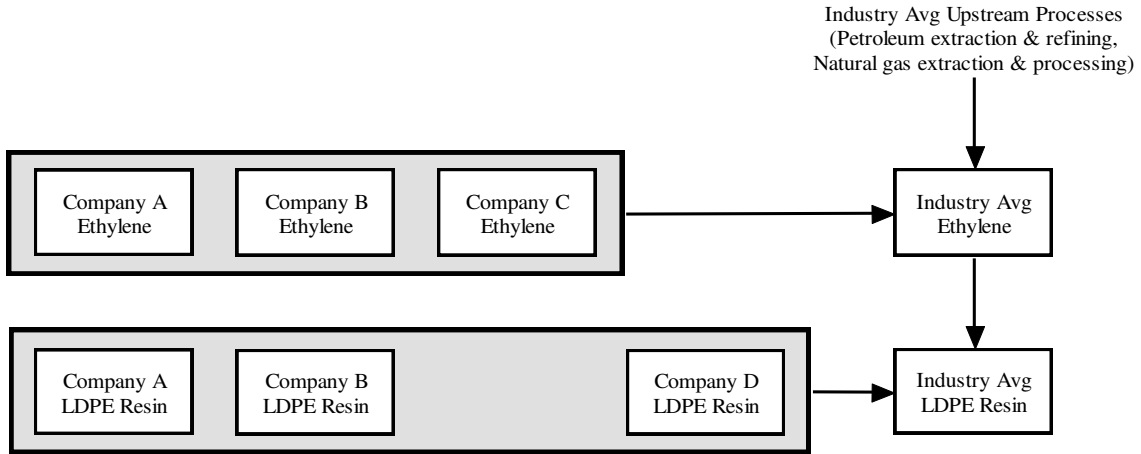

Figure AD-1. Flow diagram of the use of horizontal averaging to calculate primary average LDPE data.

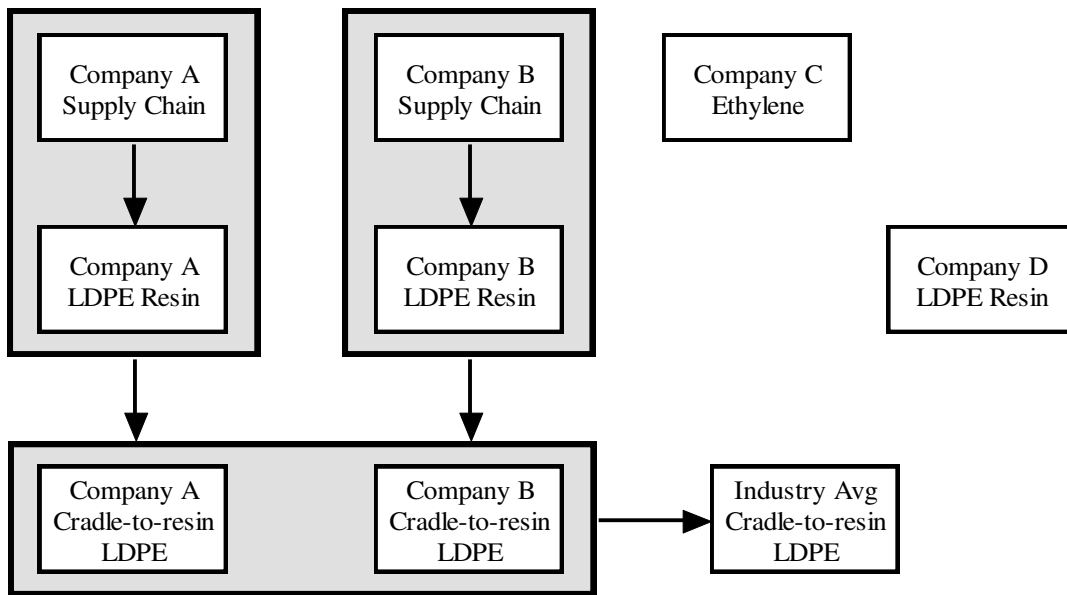

Figure AD-2. Flow diagram of the use of vertical averaging to calculate primary average LDPE data.

Boustead Consulting analyzed the difference in cradle-to-resin results obtained by each of these two methods, using hydrocrackers (ethylene output) as a case study. The total energy using vertical averaging was approximately 5 percent greater than the total energy using horizontal averaging. Considering the differences in Table AD-1, if sufficient data could be collected to do vertical averaging this would bring the total energy differences closer in many cases.

**Cogeneration of Steam and Electricity.** Boustead Consulting considered the efficiencies of electricity and steam used by Franklin Associates for cogeneration to be “optimistic.” An expert from a participating company provided a range of efficiencies for the electricity and steam generation for the cogeneration process. The electricity generation efficiency is 50% and steam efficiency is 80% for cogeneration in the U.S. plastics LCI database. Franklin Associates performed a sensitivity analysis on these efficiencies and found that any changes to these efficiencies would result in very small differences in the overall results of the resins/precursors.

**Coproduct Allocation Method.** Simple mass allocation is a common type of allocation used for coproducts in LCI/LCA. Franklin Associates has used this allocation method to allocate resources for the production of chlorine and sodium hydroxide from salt. The chemistry of the reaction determines the relative masses of the coproducts chlorine and sodium hydroxide that are produced from a given quantity of salt. It is not possible to control the cell to increase or decrease the amount of chlorine or caustic soda resulting from this given input of salt. Furthermore, sodium hydroxide cannot be obtained without producing the valuable coproducts chlorine and hydrogen.

While stoichiometric allocation tracks the masses of individual ions from the input salt, the fact remains that the output of the reaction is chlorine gas and sodium hydroxide rather than sodium ions and chlorine ions. The relative masses of the output products are different than the relative masses of the sodium and chlorine ions in the salt. The chemistry of the reaction determines the types and relative masses of the output products that are formed from the component ions of the input salt. Thus, the inputs are allocated based on the relative masses of output products formed.

Boustead Consulting uses stoichiometric allocation for the salt input to the chlorine/caustic production. Hydrochloric acid inputs, sulfuric acid inputs, and chlorine emissions are allocated to chlorine production. Hydrogen emissions are allocated to hydrogen production. Sodium hydroxide inputs are allocated to sodium hydroxide production. The electricity, steam, and the remaining emissions are allocated on a simple mass basis.

Franklin Associates performed a sensitivity analysis on the polyols results using stoichiometric allocation for chlorine/caustic production. The polyols use the largest amount of sodium hydroxide of all the resins/precursors, so these results are most sensitive to the choice of allocation method. The total energy for each of the polyols would increase by approximately 1 MJ/kg of polyol if stoichiometric allocation were used. This amount is approximately 1 percent of the total energy for the polyol. It should be noted that use of stoichiometric allocation by Franklin Associates for sodium hydroxide production would decrease the difference between the North American and European polyol total energy results by 1 percent.



**Fuel Infrastructure.** In the PlasticsEurope LCI database, plant data are calculated using fuel infrastructure from the country where the plant is located. An overall average U.S. electricity grid is used for the plastics LCI database. While it is true that U.S. regional grids differ, the use of horizontal averaging makes the use of regional grids difficult. For example, the ABS plants are from two different U.S. regions. To produce a regional average electricity grid for each average dataset would have required significantly more modeling effort.

Table AD-4 displays the differences between the North American regional grids and the North American average grid. Most of the plants where data was collected are in the Texas and Eastern regions with only a few from the Western region. This leads us to believe that if regional grids were used, it is likely total energy of the resins/precursors would increase by a small percentage, likely **less than two percent** by our estimates. Although the energy total for the Texas regional grid is approximately 20 percent greater than for the North American average grid, the energy total for the Eastern regional grid is approximately 1 percent greater than for the North American average grid, and the energy total for the Western regional grid is approximately 14 percent less than for the North American average grid. Franklin Associates estimates that the primary data collected was about 55 percent in the Texas region, 40 percent in the Eastern region and 5 percent in the Western region. Electricity use generally makes up in the order of 10-20 percent of the total energy of the cradle-to-gate resin production. From these figures, we can estimate:

$$20\% * 55\% + 1\% * 40\% + -14\% * 5\% = 10.7\% \text{ increase in electrical energy}$$

$$10.7\% * 20\% \text{ of total energy from electricity} = 2.1\% \text{ increase in total energy as estimate.}$$

Thus, the small estimated change in total energy does not appear to justify the level of effort that would be required for regional grid modeling.

Table AD-4

## Comparison of Regional and Average Electricity Grids for North America

Grid	Percent of kWh					
	Coal	Oil	Natural Gas	Nuclear	Hydro	Other
North American Average Grid	52.2%	2.8%	15.7%	19.6%	7.1%	2.6%
Texas Grid	35.5%	0.9%	50.1%	11.9%	0.2%	1.6%
Eastern U.S. Grid (1)	58.9%	3.3%	10.1%	22.6%	2.9%	2.2%
Western U.S. Grid (2)	32.4%	0.6%	23.2%	11.1%	28.1%	4.6%

Grid	MM Btu/1,000 kWh						Total
	Coal	Oil	Natural Gas	Nuclear	Hydro	Other	
North American Average Grid	2.06	0.55	6.07	0.27	1.45	0.28	10.68
Texas Grid	6.77	0.33	4.55	0.01	0.95	0.18	12.80
Eastern U.S. Grid (1)	1.35	0.63	6.81	0.11	1.66	0.24	10.81
Western U.S. Grid (2)	2.94	0.20	3.71	1.04	0.81	0.48	9.17

(1) The Eastern U.S. Grid includes states/provinces from the Atlantic Ocean as far west as Oklahoma, Kansas, Nebraska, South Dakota, North Dakota, and Saskatchewan.

(2) The Western grid includes states/provinces west of those listed in the Eastern grid.

## CONCLUSION

Based on careful and thorough analysis of each area where differences were identified between the Plastics Division of the ACC and PlasticsEurope databases, it has been agreed by the Plastics Division of the ACC and PlasticsEurope that the differences in results (shown in Table AD-1) are justified and acceptable as of 2007. The 2011 ACC results are consistent with the additional data collection efforts and the methodology differences for handling fuels produced within the production of a number of intermediate chemicals (including the hydrocracker) that were the basis for the 2007 data collection.

## DIFFERENCES BETWEEN 2010 INTERMEDIATE DATA AND 2011 FINAL DATA

As this plastics database is to be made available to the public in general through the U.S. LCI Database, an intense review of all data was carried out by Franklin Associates. Most of the differences between the July, 2010 data and the August, 2011 data were small, however, the update of the oil and gas did change the data to an extent. Some of the larger differences occur in the metals emissions from the crude oil and natural gas extraction. A comparison of the total energy and carbon dioxide equivalents results are shown in Table AD-5.

As can be seen in Table AD-5, the resins/precursors with the greatest changes in total energy include HDPE, LDPE, LLDPE, PP, PET and TDI. The details of the changes made to all the datasets are shown in this section. One correction made to all of the resins/precursors includes the corrected calculation of the fuel use for cogeneration. The decrease of the total energy due to this factor depended on the extent that cogeneration was used in each resin/precursor. The energy decrease also is connected to the update of the oil and gas data update. The data for methanol, hydrogen and carbon monoxide were changed to reflect more recent datasets. None of the resins or precursors had large changes in their total carbon dioxide equivalents.

Table AD-5

Total Energy and CO2 Equivalent Comparison of 2010 and 2011 ACC Plastics LCI Database  
(Basis: 1 kg of resin or precursor)

	2011 Total	2010 Total	2011 Total	2010 Total	Energy Difference*		CO2 Equiv. Difference*	
	Energy (MJ)	Energy (MJ)	CO2 Equiv. (kg CO2 eq.)	CO2 Equiv. (kg CO2 eq.)	(MJ)	(%)	(kg CO2 eq.)	(%)
HDPE	78.3	83.2	1.897	1.890	-4.9	-12%	0.007	0%
LDPE	83.6	88.6	2.201	2.210	-5.0	-11%	-0.009	0%
LLDPE	78.0	83.0	1.901	1.924	-5.0	-12%	-0.023	0%
PP	77.0	81.3	1.860	1.868	-4.3	-10%	-0.008	0%
PET	70.4	74.2	2.733	2.798	-3.8	-10%	-0.065	0%
GPPS	95.1	98.7	3.242	3.175	-3.6	-7%	0.067	0%
HIPS	96.1	99.8	3.259	3.194	-3.7	-7%	0.065	0%
PVC	59.2	59.0	2.419	2.255	0.2	1%	0.164	1%
ABS	105.0	109.0	3.805	3.749	-4.0	-7%	0.056	0%
Polyol-Rigid Polyurethane	83.1	82.3	3.718	3.538	0.8	2%	0.180	0%
Polyol-Flexible Polyurethane	95.7	95.1	4.035	3.853	0.6	1%	0.182	0%
MDI	59.8	61.2	2.377	2.289	-1.4	-4%	0.088	0%
TDI	51.8	55.3	2.107	2.212	-3.5	-12%	-0.105	0%

Note: Polyols are one category in the PlasticsEurope database

\* Difference = 2011 results - 2010 results  
% difference = (difference between results)/(average of results)

With the update of the crude oil and natural gas data, the precombustion energy and emissions were also updated in all resins and polyurethane precursors. The following is a list of changes made to the July, 2010 models.

- HDPE Model
  1. Changed CFC's emission category to CFC-12 for petroleum refining unit process
  2. Swapped incorrect emissions for natural gas extraction and petroleum refining

3. Corrected calculation of fuel use for cogeneration in all unit processes using cogeneration
  4. Updated oil and gas data, including material loss factors and EMR values
  5. Included fugitive emissions from natural gas pipelines
- LDPE Model
    1. Changed CFC's emission category to CFC-12 for petroleum refining unit process
    2. Corrected calculation of fuel use for cogeneration in all unit processes using cogeneration
    3. Updated oil and gas data, including material loss factors and EMR values
    4. Included fugitive emissions from natural gas pipelines
  - LLDPE Model
    1. Changed CFC's emission category to CFC-12 for petroleum refining unit process
    2. Corrected calculation of fuel use for cogeneration in all unit processes using cogeneration
    3. Updated oil and gas data, including material loss factors and EMR values
    4. Included fugitive emissions from natural gas pipelines
  - PP Model
    1. Changed CFC's emission category to CFC-12 for petroleum refining unit process
    2. Corrected calculation of fuel use for cogeneration in all unit processes using cogeneration
    3. Updated oil and gas data, including material loss factors and EMR values
    4. Included fugitive emissions from natural gas pipelines
  - PET Model
    1. Changed CFC's emission category to CFC-12 for petroleum refining unit process
    2. Carbon monoxide and methanol data updated
    3. Corrected calculation of fuel use for cogeneration in all unit processes using cogeneration Updated oil and gas data, including material loss factors and EMR values
    4. Included fugitive emissions from natural gas pipelines
  - GPPS Model
    1. Changed CFC's emission category to CFC-12 for petroleum refining unit process
    2. Corrected calculation of fuel use for cogeneration in all unit processes using cogeneration
    3. Updated oil and gas data, including material loss factors and EMR values
    4. Included fugitive emissions from natural gas pipelines

- HIPS Model
  1. Changed CFC's emission category to CFC-12 for petroleum refining unit process
  2. Corrected calculation of fuel use for cogeneration in all unit processes using cogeneration
  3. Updated oil and gas data, including material loss factors and EMR values
  4. Included fugitive emissions from natural gas pipelines
- PVC Model
  1. Changed CFC's emission category to CFC-12 for petroleum refining unit process
  2. Corrected calculation of fuel use for cogeneration in all unit processes using cogeneration
  3. Updated oil and gas data, including material loss factors and EMR values
  4. Included fugitive emissions from natural gas pipelines
- ABS Model
  1. Changed CFC's emission category to CFC-12 for petroleum refining unit process
  2. Corrected calculation of fuel use for cogeneration in all unit processes using cogeneration
  3. Updated oil and gas data, including material loss factors and EMR values
  4. Included fugitive emissions from natural gas pipelines
- Polyol—Rigid Polyurethane Model
  1. Changed CFC's emission category to CFC-12 for petroleum refining unit process
  2. Corrected pipeline transport for propylene unit process
  3. Corrected calculation of fuel use for cogeneration in all unit processes using cogeneration
  4. Corrected recovered energy value in polyol production
  5. Updated oil and gas data, including material loss factors and EMR values
  6. Included fugitive emissions from natural gas pipelines
- Polyol—Flexible Polyurethane Model
  1. Changed CFC's emission category to CFC-12 for petroleum refining unit process
  2. Changed aldehydes emission category to acetaldehyde in the ethylene oxide unit process
  3. Methanol data updated
  4. Biomass process energy has been added to palm kernel production unit process
  5. Corrected weight factor for the oxygen unit process
  6. Corrected calculation of fuel use for cogeneration in all unit processes using cogeneration
  7. Updated natural gas input to ammonia

8. Updated oil and gas data, including material loss factors and EMR values
9. Included fugitive emissions from natural gas pipelines
- MDI Model
  1. Changed HFC-22 atmospheric emission flow name to HCFC-22
  2. Changed CFC's emission category to CFC-12 for petroleum refining unit process
  3. Corrected formaldehyde weight factor, which affected all raw material weights
  4. Hydrogen, carbon monoxide, and methanol data updated
  5. Corrected weight factor for natural gas unit process going to ammonia
  6. Corrected weight factor formula for petroleum refining unit process
  7. Corrected calculation of fuel use for cogeneration in all unit processes using cogeneration
  8. Updated oil and gas data, including material loss factors and EMR values
  9. Corrected Atmospheric carbon tetrachloride emission for MDI production
  10. Corrected weight factor for internal offgas use
  11. Included fugitive emissions from natural gas pipelines
- TDI Model
  1. Changed HFC-22 atmospheric emission flow name to HCFC-22
  2. Changed CFC's emission category to CFC-12 for petroleum refining unit process
  3. Changed toluene emission value from 0.34 lbs/1000 lbs natural gas to 0.15 lbs/1000 lbs natural gas in the natural gas processing unit process
  4. Inserted values for xylene, benzene, ethylbenzene in the natural gas processing unit process
  5. Inserted nitrates water emissions in the TDI unit process
  6. Corrected DNT transport in DNT/TDA/Phosgene/TDI unit process
  7. Carbon monoxide data updated
  8. Corrected calculation of fuel use for cogeneration in all unit processes using cogeneration
  9. Updated crude oil and natural gas data within the sulfur production
  10. Updated oil and gas data, including material loss factors and EMR values
  11. Updated weight factor of natural gas going to ammonia
  12. Included fugitive emissions from natural gas pipelines

## **BIBLIOGRAPHY**

Following is a list of the publicly available government, industry, and technical publications, reports, and websites utilized in the development of the LCI models for each resin or precursor and preparation of the LCI report.

This bibliography does not include the many confidential data sources and conversations with industry experts utilized in developing the LCI data and models.

### **DATA ON THE PRODUCTION AND COMBUSTION OF FUELS FOR PROCESS AND TRANSPORTATION ENERGY (INCLUDING ELECTRICITY GENERATION)**

Energy and Environmental Profile of the U.S. Mining Industry. U.S. Department of Energy, Office of Energy Efficiency and Renewable Energy. December 2002.

**Encyclopedia of Chemical Technology.** Kirk-Othmer. Volume 23, Third Edition. 1983.

Energy Technologies Characterization Handbook: Environmental Pollution and Control Factors. March 1983, Third Edition. Department of Energy. 1983.

AP-42 Emissions Factors, Mineral Products Industry, Western Surface Coal Mining, Section 11.9. October 1998.

The Chemistry and Technology of Coal, Second Edition. James G. Speight. Western Research Institute. Marcel Dekker, Inc. New York. 1994.

Review of Surface Coal Mining Emission Factors. U.S. EPA Office of Air Quality Planning and Standards. EPA-454/R-95-007. July 1991.

Revision of Emission Factors for AP-42 Section 11.9, Western Surface Coal Mining. Revised Final Report. U.S. EPA Office of Air Quality Planning and Standards. September 1998.

An Improved Inventory of Methane Emissions from Coal Mining in the United States. Journal of the Air and Waste Management Association. Volume 50. November 2000.

Bituminous Coal Underground Mining. 1997 Economic Census. U.S. Census Bureau. U.S. Department of Commerce. October 1998.

Bituminous Coal and Lignite Surface Mining. 1997 Economic Census. U.S. Census Bureau. U.S. Department of Commerce. October 1999.

Code of Federal Regulations. Title 40 – Protection of Environment. Part 434 – Coal Mining Point Source Category BPT, BAT, BCT Limitations and New Source Performance Standards.

Hong, B.D. U.S. Coal Supply and Demand: 1997 Review. Energy Information Administration. U.S. Department of Energy. 1997.

Coal Industry Annual 1997. Energy Information Administration. U.S. Department of Energy. DOE/EIA-0584, 1997

Energy Policy Act Transportation Rate Study: Final Report on Coal Transportation. Energy Information Administration. U.S. Department of Energy. DOE/EIA-0597 (2000). October 2000.

Coal Industry Annual 2000. Energy Information Administration. U.S. Department of Energy. DOE/EIA-0584, 2000.

Coal Data: A Reference. Energy Information Administration. U.S. Department of energy. DOE/EIA-0064(93). February 1995.

Emission Factor Documentation for AP-42 Section 11.9, Mineral Products Industry: Western Surface Coal Mining. U.S. EPA. November 1998.

Emission Factor Documentation for AP-42 Section 11.10, Coal Cleaning. U.S. EPA. November 1995.

D.A. Kirchgessner, S.D. Piccot, and S.S. Masemore. “An Improved Inventory of Methane Emissions from Coal Mining in the United States”. Journal of the Air and Waste Management Association. Volume 50. November 2000.

Coal-Fired Power Plant (Eastern Coal). Environmental Characterization Information Report. U.S. Department of Energy. 1981.

EPA Office of Compliance Sector Notebook Project: Profile of the Oil and Gas Extraction Industry, October 2000, EPA/310-R-99-006

Life Cycle Inventory of Biodiesel and Petroleum Diesel, NREL/SR-580-24094

EPA, AP 42, Chapter 5.3: Natural Gas Processing, 1995.

Energy Information Administration, Natural Gas Annual 2000.

EPA Project Summary: Glycol Dehydrator BTEX and VOC Emission Testing Results at Two Units in Texas and Louisiana, Rueter, Reif, and Myers. EPA/600/SR-95/046. May 1995.



Hydrocarbon Processing. Cost-effectively Reduce Emissions for Natural Gas Processing. McMillan and Henderson. October 1999.

Tobin, J. Natural Gas Transportation - Infrastructure Issues and Operational Trends.

Energy Information Administration: Natural Gas Division. October 2001.

Rand McNally Illustrated Atlas of the World. 1992. (Map of U.S.)

The U.S. Petroleum and Natural Gas Industry (Table 2), Energy Information Administration, 1999.

1997 Census of Mineral Industries. Crude Petroleum & Natural Gas Extraction. Energy Information Administration. EC97N-2111A

Oil and Gas Journal 1998 Databook.

WORLD BANK GROUP, Pollution Prevention and Abatement Handbook: Oil and Gas Development (Onshore), 1998.

Overview of Exploration and Production Waste Volumes and Waste Management Practices in the United States. Based on API Survey of Onshore and Coastal Exploration and Production Operations for 1995 and API Survey of Natural Gas Processing Plants for 1995. Prepared for the American Petroleum Institute. Prepared by ICF Consulting. May 2002.

Energy Information Administration. Petroleum Supply Annual 1993. Volume 1. June, 1994.

Environmental Benefits of Advanced Oil and Gas Exploration and Production Technology. U.S. Department of Energy: Office of Fossil Energy. 1998.

Energy Information Administration. Petroleum Supply Annual 2001. Volume 2.

World Ports Distances ([www.distances.com](http://www.distances.com)). Intership Ltd.

**Inventory of U.S. Greenhouse Gas Emissions and Sinks: 1990-2000**, Table 2-29: CH<sub>4</sub> Emissions from Petroleum Systems. U.S. Environmental Protection Agency, Office of Atmospheric Programs, EPA 430-R-02-003, April 2002.

Energy and Environmental Profile of the U.S. Petroleum Industry. U.S. Department of Energy Office of Industrial Technologies. December 1998.

Annual Energy Review 2001. Table 5.8: Refinery Input and Output. Energy Information Administration.

Estimating Externalities of Oil Fuel Cycles. Oak Ridge National Laboratory and Resources for the Future. August 1996.

Association of Oil Pipelines Annual Report 2000.

ASTM-IP Petroleum Measurement Tables.

AP 42, Chapter 5, Petroleum Refining, U.S. Environmental Protection Agency, January 1995.

Compilation of Air Pollutant Emission Factors, Volume I: Stationary Point and Area Sources. Fifth Edition. U.S. Environmental Protection Agency. July 1995.

Industrial Resource Recovery Practices: Petroleum Refineries and Related Industries. Prepared for U.S. Environmental Protection Agency, Office of Solid Waste, Washington, D.C. by Franklin Associates, Ltd., January 1983.

Oil and Gas Industry Exploration and Production Wastes. Prepared by ERT for American Petroleum Institute. July 1987.

Renewable Resources in the U.S. Electricity Supply. EIA, Office of Coal, Nuclear, Electric and Alternate Fuels. February 1993.

DeLuchi, M.A., "Emissions of Greenhouse Gases from the Use of Transportation Fuels and Electricity. 1991.

Oak Ridge National Laboratory, "Estimating Externalities of Nuclear Fuel Cycles", 1995.

1997 Economic Census, Mining, Industry Series, U.S. Department of Commerce. August 1999.

U.S. Department of Energy, "Energy Technology Characterizations Handbook", 1981.

Energy Information Administration. Uranium Industry Annual 2001, Table 12: Owners and Operators of U.S. Civilian Nuclear Power Reactors Purchased Uranium by Origin Country and Delivery Year (thousand pounds U<sub>3</sub>O<sub>8</sub> equivalent).

Nuclear Fuel Material Balance Calculator ([www.antenna.nl/wise/uranium/nfcm.html](http://www.antenna.nl/wise/uranium/nfcm.html))

Finch, W.I. Uranium, Its Impact on the National and Global Energy Mix. U.S. Geological Survey Circular 1141. United States Government Printing Office, Washington, 1997.

Vance, R.E. Canadian Mineral Yearbook, 2000.

EGRID 2002 (Emissions and Generation Resource Integrated Database). U.S. EPA. ([www.epa.gov/cleanenergy/egrid](http://www.epa.gov/cleanenergy/egrid)).

EIA-906 Database: Monthly Utility Power Plant Database. Energy Information Administration. (<http://www.eia.doe.gov/cneaf/electricity/page/eia906u.html>)

Emission Factor Documentation for AP-42, Section 1.2.1, Tables 1.2-1, 1.2-2, and 1.2-3, 1.2-4, 1.2-5, 1.2-6, and 1.2-7. Anthracite Coal Combustion. U.S. Environmental Protection Agency. October 1996.

Energy Information Administration, Electric Power Annual 2000 Volume II, Table A4.

Energy Information Administration, Inventory of Electric Utility Power Plants in the United States 2000.

EPA Report to Congress: Waste from the Combustion of Fossil Fuels – Volume 2. EPA 530-R-99-010. U.S. Environmental Protection Agency Office of Solid Waste. March 1999.

Code of Federal Regulations. Title 40, Part 423. July 2002.

Cost and Quality of Fuels for Electric Utility Plants 2000. EIA.

Energy Information Administration. Annual Steam-Electric Plant Operation and Design Data. Website: <http://www.eia.doe.gov/cneaf/electricity/page/eia767.html>.

EPA, Study of Hazardous Air Pollutant Emissions from Electric Utility Steam Generating Units -- Final Report to Congress, Volume I, EPA 1998. EPA-453/R-98-004a

Emission Factor Documentation for AP-42, Section 1.1. Bituminous and Subbituminous Utility Combustion. U.S. Environmental Protection Agency. August 1998.

Innovative Application of Coal Combustion Products (CCPs). American Coal Ash Association (ACCA), 1998, page 68.

Energy Information Administration. Electric Power Annual 2000 Volume II. Table 27: FGD Capacity in Operation at U.S. Electric Utility Plants as of December 2000.

Emission Factor Documentation for AP-42, Section 1.7. Lignite Combustion. Tables 1.7-1, 1.7-4, 1.7-5, and 1.7-8. U.S. Environmental Protection Agency. August 1998.

EPA Inventory Database v4.1 - Boilers at website <http://www.epa.gov/ttn/atw/combust/iccrarch/bo.html>. Tables A-1 through A-5, A-7, A-8. 1997 data.

National Air Pollutant Emission Trends, U.S. EPA, EPA-454/R-00-002, March 2000.

Table from Quarterly Coal Report--HTML Tables. Found at <http://www.eia.doe.gov/cneaf/coal/quarterly/html/t28p01p1.html>. Table 29. U.S. Coal Consumption by End-Use Sector 1997-2003

"Coal Combustion Products", Minerals Yearbook 2000, USGS, 2000

Electric Power Annual 1996, Volume I. EIA, Office of Coal, Nuclear, Electric and Alternate Fuels. August 1997.

GREET Version 1.6 (draft). Developed by Michael Wang. Center for Transportation Research, Argonne National Laboratory. October 2001.

Emission Factor Documentation for AP-42: External Combustion Sources. Section 1.3 - Fuel Oil Combustion. U.S. Environmental Protection Agency. 1998.

Study of Hazardous Air Pollutant Emissions from Electric Utility Steam Generating Units -- Final Report to Congress (Volume 2, Appendices). EPA-453/R-98-004b. U.S. Environmental Protection Agency. February 1998.

**Transportation Energy Databook: Edition 21.** Oak Ridge National Laboratory. October 2001.

**Transportation Energy Data Book: Edition 22.** Oak Ridge National Laboratory. September 2002.

Energy Information Administration. Annual Energy Review 2001. Table 9.3: Uranium Overview.

Energy Information Administration. Monthly Energy Review February 2003. Table 8.1: Nuclear Power Plant Operations.

WISE Uranium Project. Nuclear Fuel Material Balance Calculator ([www.antenna.nl/wise/uranium/nfcm.html](http://www.antenna.nl/wise/uranium/nfcm.html))

AP-42 Emission Factors. Stationary Internal Combustion Sources. Table 3.1-3. April 2000.

Emission Factor Documentation for AP-42: Stationary Internal Combustion Sources. Table 3.3-2. October 1996.

Environmental Consequences of, and Control Processes for, Energy Technologies. Argonne National Laboratory. 1990. Pp. 329-333.

AP-42 Emission Factors. External Combustion Sources. Section 1.6 - Wood Residues Combustion in Boilers. Supplement G, 2001.

National Transportation Statistics 2002. Tables 4-14 and 4-14. Bureau of Transportation Statistics.

1997 Economic Census. Vehicle Inventory and Use Survey. U.S. Census Bureau. U.S. Dept. of Commerce. October 1999. Table 4. P. 37.

Railroad Facts 2002. Page 40. Association of American Railroads. 2002.

Anthracite Mining. 1997 Economic Census. U.S. Census Bureau. U.S. Department of Commerce. July 1999.

**ICAO Engine Exhaust Emissions Data Bank: Subsonic Engines.**

**Engine Yearbook 2004.** Aviation Industry Press ([www.aviation-industry.com](http://www.aviation-industry.com))

**Aircraft Contrails Factsheet.** U.S. Environmental Protection Agency, Office of Air and Radiation. EPA430-F-00-005. September 2000.

Energy Information Administration. **Annual Energy Review 2004.** Table 8.6c: Estimated Consumption of Combustible Fuels for Useful Thermal Output at Combined-Heat-and-Power Plants: Commercial and Industrial Sectors, 1989-2004.

Energy Information Administration. **Annual Energy Review 2004.** Table 8.5d: Consumption of Combustible Fuels for Electricity Generation: Commercial and Industrial Sectors, 1989-2004.

Energy Information Administration. **Annual Energy Review 2004.** Table 8.7c: Consumption of Combustible Fuels for Electricity Generation and Useful Thermal Output: Commercial and Industrial Sectors, 1989-2004.

**Catalogue of CHP Technologies.** U.S. Environmental Production Agency, Combined Heat and Power Partnership. 2002.

Life Cycle Inventory of Biodiesel and Petroleum Diesel, NREL/SR-580-24089

Energy Information Administration. **Petroleum Supply Annual 2001.** Volume 1.

Alaska pipeline website: [<http://www.alyeska-pipe.com/pipelinefacts.html>]

Distances are from <http://www.indo.com/cgi-bin/dist> and are "as the crow flies".

Annual Energy Review 2001. Table 5.2: Crude Oil Production and Oil Well Productivity. Energy Information Administration.

Development Document for Final Effluent Limitations Guidelines and Standards for the Coastal Subcategory of the Oil and Gas Extraction Point Source Category, EPA 821-R-96-023, page VII-12.

A White Paper Describing Produced Water from Production of Crude Oil, Natural Gas, and Coal Bed Methane. Prepared for U.S. Department of Energy National Energy Technology Laboratory under Contract W-31-109-Eng-38 by Argonne National Laboratory. January 2004.

Data Summary of Offshore Drilling Waste Disposal Practices. Prepared for U.S. EPA Engineering and Analysis Division and U.S. Department of Energy Office of Fossil Energy by John Veil, Argonne National Laboratory. November 1998.

Inventory of U.S. Greenhouse Gas Emissions and Sinks: 1990-2009, U.S. Environmental Protection Agency, Office of Atmospheric Programs, Tables 3-42 and 3-44 (emissions from petroleum systems).

## **PRODUCTION OF HDPE RESIN**

APC Plastics Industry Producers' Statistics Group, as compiled by VERIS Consulting, LLC. 2004.

Overview of Exploration and Production Waste Volumes and Waste Management Practices in the United States. Based on API Survey of Onshore and Coastal Exploration and Production Operations for 1995 and API Survey of Natural Gas Processing Plants for 1995. Prepared for the American Petroleum Institute. Prepared by ICF Consulting. May 2002.

Energy Information Administration. **Petroleum Supply Annual 1993**. Volume 1. June, 1994.

**Environmental Benefits of Advanced Oil and Gas Exploration and Production Technology**. U.S. Department of Energy: Office of Fossil Energy. 1998.

**Inventory of U.S. Greenhouse Gas Emissions and Sinks: 1990-2000**, Table 2-29: CH<sub>4</sub> Emissions from Petroleum Systems. U.S. Environmental Protection Agency, Office of Atmospheric Programs, EPA 430-R-02-003, April 2002.

Energy Information Administration. **Petroleum Supply Annual 2001**. Volume 2.

World Ports Distances ([www.distances.com](http://www.distances.com)). Intership Ltd.

1997 Census of Mineral Industries. Crude Petroleum & Natural Gas Extraction. Energy Information Administration. EC97N-2111A

Oil and Gas Journal 1998 Databook.

EPA Office of Compliance Sector Notebook Project: Profile of the Oil and Gas Extraction Industry, October 2000, EPA/310-R-99-006

Life Cycle Inventory of Biodiesel and Petroleum Diesel, NREL/SR-580-24094

Energy Information Administration. **Petroleum Supply Annual 2001**. Volume 1.

Alaska pipeline website: [<http://www.alyeska-pipe.com/pipelinefacts.html>]

Distances are from <http://www.indo.com/cgi-bin/dist> and are "as the crow flies".

Annual Energy Review 2001. Table 5.8: Refinery Input and Output. Energy Information Administration.

WORLD BANK GROUP, Pollution Prevention and Abatement Handbook: Oil and Gas Development (Onshore), 1998.

**Industrial Resource Recovery Practices: Petroleum Refineries and Related Industries.** Prepared for U.S. Environmental Protection Agency, Office of Solid Waste, Washington, D.C. by Franklin Associates, Ltd., January 1983.

Calculation by Franklin Associates based on annual energy consumption data provided by U.S. Department of Energy (**Energy and Environmental Profile of the U.S. Petroleum Industry**. U.S. Department of Energy Office of Industrial Technologies. December 1998.)

**Compilation of Air Pollutant Emission Factors, Volume I: Stationary Point and Area Sources.** Fifth Edition. U.S. Environmental Protection Agency. July 1995.

1997 Census of Mineral Industries. Crude Petroleum & Natural Gas Extraction. Energy Information Administration. EC97N-2111A

**Energy and Environmental Profile of the U.S. Petroleum Industry.** U.S. Department of Energy Office of Industrial Technologies. December 1998.

**Estimating Externalities of Oil Fuel Cycles.** Oak Ridge National Laboratory and Resources for the Future. August 1996.

Association of Oil Pipelines Annual Report 2000.

ASTM-IP Petroleum Measurement Tables.

AP 42, Chapter 5, Petroleum Refining, Natural Gas Processing. U.S. Environmental Protection Agency, January 1995.

Energy Information Administration, Natural Gas Annual 2000.

EPA Project Summary: Glycol Dehydrator BTEX and VOC Emission Testing Results at Two Units in Texas and Louisiana, Rueter, Reif, and Myers. EPA/600/SR-95/046. May 1995.

Hydrocarbon Processing. Cost-effectively Reduce Emissions for Natural Gas Processing. McMillan and Henderson. October 1999.

Tobin, J. Natural Gas Transportation - Infrastructure Issues and Operational Trends.

The U.S. Petroleum and Natural Gas Industry (Table 2), Energy Information Administration, 1999.

Energy Information Administration: Natural Gas Division. October 2001.

Rand McNally Illustrated Atlas of the World. 1992. (Map of U.S.)

**Oil and Gas Industry Exploration and Production Wastes.** Prepared by ERT for American Petroleum Institute. July 1987.

**Renewable Resources in the U.S. Electricity Supply.** EIA, Office of Coal, Nuclear, Electric and Alternate Fuels. February 1993.

Oil and Gas Journal 1998 Databook.

Chemical Profile: Ethylene. **Chemical Market Reporter.** September 29, 2003. Page 27.

Chemical profile information taken from the website:  
<http://www.the-innovation-group.com/welcome.htm>

Life Cycle Inventory of Biodiesel and Petroleum Diesel, NREL/SR-580-24089

EPA, AP 42, Chapter 5.3: Natural Gas Processing, 1995.

Annual Energy Review 2001. Table 5.2: Crude Oil Production and Oil Well Productivity. Energy Information Administration.

Development Document for Final Effluent Limitations Guidelines and Standards for the Coastal Subcategory of the Oil and Gas Extraction Point Source Category, EPA 821-R-96-023, page VII-12.

A White Paper Describing Produced Water from Production of Crude Oil, Natural Gas, and Coal Bed Methane. Prepared for U.S. Department of Energy National Energy Technology Laboratory under Contract W-31-109-Eng-38 by Argonne National Laboratory. January 2004.



Data Summary of Offshore Drilling Waste Disposal Practices. Prepared for U.S. EPA Engineering and Analysis Division and U.S. Department of Energy Office of Fossil Energy by John Veil, Argonne National Laboratory. November 1998.

Inventory of U.S. Greenhouse Gas Emissions and Sinks: 1990-2009, U.S. Environmental Protection Agency, Office of Atmospheric Programs, Tables 3-42 and 3-44 (emissions from petroleum systems).

### **PRODUCTION OF LDPE RESIN**

APC Plastics Industry Producers' Statistics Group, as compiled by VERIS Consulting, LLC. 2004.

Chemical profile information taken from the website:  
<http://www.the-innovation-group.com/welcome.htm>

### **PRODUCTION OF LLDPE RESIN**

APC Plastics Industry Producers' Statistics Group, as compiled by VERIS Consulting, LLC. 2004.

Chemical profile information taken from the website:  
<http://www.the-innovation-group.com/welcome.htm>

### **PRODUCTION OF PP RESIN**

APC Plastics Industry Producers' Statistics Group, as compiled by VERIS Consulting, LLC. 2004.

Chemical profile information taken from the website:  
<http://www.the-innovation-group.com/welcome.htm>

### **PRODUCTION OF PET RESIN**

APC Plastics Industry Producers' Statistics Group, as compiled by VERIS Consulting, LLC. 2004.

Chemical profile information taken from the website:  
<http://www.the-innovation-group.com/welcome.htm>

**Hydrocarbon Processing.** Petrochemical Processes, 1985. November, 1985.

**Water Pollution Abatement Technology: Capabilities and Cost, Organic Chemicals Industry.** National Commission on Water Quality Report No. 75/03, June, 1975.

**Hydrocarbon Processing.** Gas Processes 2002. May, 2002.

**Compilation of Air Pollutant Emission Factors, Volume I: Stationary Point and Area Sources.** Fifth Edition. U.S. Environmental Protection Agency. July 1995.

**Energy and Environmental Profile of the U.S. Chemical Industry.** Prepared by Energetics Inc. for the U.S. Department of Energy. May, 2000.

Information taken from the website:

<http://www.gtchouston.com/technologie/otech-dmt.htm>

## **PRODUCTION OF GPPS RESIN**

APC Plastics Industry Producers' Statistics Group, as compiled by VERIS Consulting, LLC. 2004.

Kent, James A, ed. **Riegel's Handbook of Industrial Chemistry.** Tenth Edition. Kluwar Academic/Plenum Publishers, New York, 2003.

Seigel, Jason. "High Benzene Tags will Affect Downstream Products' Costs." From the website [www.purchasing.com/article/CA436076.html](http://www.purchasing.com/article/CA436076.html) July 15, 2004.

SRI, 1993 as referenced in Toxicological Profile for Benzene. 4. Production, Import/Export, Use and Disposal. 1997. From the website: [www.atsdr.cdc.gov/toxprofiles/tp3-c4.pdf](http://www.atsdr.cdc.gov/toxprofiles/tp3-c4.pdf)

Chemical profile information taken from the website:

<http://www.the-innovation-group.com/welcome.htm>

Distances calculated using the websites:

<http://www.indo.com/distance/> and <http://www.mapquest.com/>

**Hydrocarbon Processing.** "Petrochemical Processes 1997." March 1997.

Information taken from the website:

<http://www.inchem.org/documents/jecfa/jecmono/v50je04.htm>

**Energy and Environmental Profile of the U.S. Petroleum Industry.** U.S. Department of Energy Office of Industrial Technologies. December 1998.

Radian Corporation. **Polymer Manufacturing: Technology and Health Effects.** Noyes Data Corporation, New Jersey, 1986.

Chemical Profile: Benzene. **Chemical Market Reporter.** November 11, 2002. Page 38.

## **PRODUCTION OF HIPS RESIN**

APC Plastics Industry Producers' Statistics Group, as compiled by VERIS Consulting, LLC. 2004.

Chemical profiles information taken from the website:

<http://www.the-innovation-group.com/welcome.htm>

Distances calculated using the websites:

<http://www.indo.com/distance/> and <http://www.mapquest.com/>

Texas Air Control Board, 1970 Emissions Data, Self-reporting System, Nonpublished data.

Texas Water Quality Board, Wastewater Effluent Report, 1972. Unpublished data extracted from Self-reporting Data. Submitted by companies located in Texas to the TWQB.

Midwest Research Institute. Private Data used for Estimates. 1974.

Kent, James A., ed. **Riegel's Handbook of Industrial Chemistry**. 10<sup>th</sup> Edition. 2003.

Radian Corporation. **Polymer Manufacturing: Technology and Health Effects**. Noyes Data Corporation, New Jersey, 1986.

## **PRODUCTION OF PVC RESIN**

APC Plastics Industry Producers' Statistics Group, as compiled by VERIS Consulting, LLC. 2004.

U.S. Code of Federal Regulations. 40 CFR Chapter 1, Part 415, Inorganic Chemicals Manufacturing Point Source Category, Subpart P.

**Energy and Environmental Profile of the U.S. Chemical Industry**. Prepared by Energetics Incorporated for the U.S. Department of Energy Office of Industrial Technologies. May 2000.

Kostick, D.S., The Material Flows of Salt, Bureau of Mines Information Circular/1993, U.S. Department of Interior, September 1992.

Eco-profiles of the European Plastics Industry—Purified Brine. I. Boustead for PlasticsEurope. March, 2005.

Chemical profiles information taken from the website:

<http://www.the-innovation-group.com/welcome.htm>

Chemical Profile: Caustic Soda. Chemical Market Reporter (www.chemicalmarketreporter.com). June 9, 2003.

Chemical Market Associates, Inc. findings given to The Vinyl Institute. February 7, 2005.

**Reigel's Handbook of Industrial Chemistry.** Tenth Edition. Edited by James A. Kent. Kluwar Academic / Plenum Publishers. New York. 2003.

Chemical Profile: Vinyl Chloride. Mark Kirschner. **Chemical Market Reporter.** November 17, 2003. Page 39.

### **PRODUCTION OF ABS RESIN**

Tullo, Alexander H. "Styrenics Makers Seek Market Niche." **Chemical and Engineering News.** September 12, 2005. Volume 83, Number 37. pp. 25-26

**Reigel's Handbook of Industrial Chemistry.** Tenth Edition. Edited by James A. Kent. Kluwar Academic / Plenum Publishers. New York. 2003.

Chemical profiles information taken from the website:  
<http://www.the-innovation-group.com/welcome.htm>

U.S. EPA. Unpublished records on industrial pollutants. Dallas, TX. 1973.

Chemical Profile: ABS Resins. Mark Kirschner. **Chemical Market Reporter.** January 13, 2003. Page 27.

### **PRODUCTION OF POLYETHER POLYOL FOR RIGID FOAM POLYURETHANE**

**The Resin Review. The Annual Statistical Report for the U.S. Plastics Industry.** American Plastics Council. 2003.

**Energy and Environmental Profile of the U.S. Mining Industry.** U.S. Department of Energy, Office of Energy Efficiency and Renewable Energy. December 2002.

**AP-42 Emission Factors. Chapter 11.19.2.** Crushed Stone Processing and Pulverized Mineral Processing. US EPA. August 2004.

Information compiled from the website: <http://www.sucrose.com/lbeet.html>

Energy and Environmental Profile of the U.S. Chemical Industry. Prepared by Energetics Inc. for the U.S. Department of Energy. May, 2000.

Chemical profiles information taken from the website:

<http://www.the-innovation-group.com/welcome.htm>

Polyurethane 102, Polyurethane Chemistry and Raw Materials. Slides and notes from the Polyurethane Professional Development Program produced by the Alliance for the Polyurethanes Industry. 2003 edition.

Data taken from the report **Resource and Environmental Profile Analysis of Three Methods of Manufacturing Liquid Sweeteners** performed by Midwest Research Institute. 1974.

## **PRODUCTION OF POLYETHER POLYOL FOR FLEXIBLE FOAM POLYURETHANE**

**The Resin Review. The Annual Statistical Report for the U.S. Plastics Industry.** American Plastics Council. 2003.

Wood, B.J., and Corley, R.H.V. **The Energy Balance of Oil Palm Cultivation.** Paper for International Oil Palm conference, Kuala Lumpur, September, 1991.

Jorgensen, H.K. "Treatment of Empty Fruit Bunches for Recovery of Residual Oil and Additional Steam Production." **Journal of American Oil Chemists Society.** Volume 62. February, 1985.

Sivasothy, K. and N.B.H. Lim. "Automation of Palm Oil Mills." **Journal of American Oil Chemists Society.** Volume 62. February, 1985.

Southworth, A. "Palm Oil and Palm Kernels." **Journal of American Oil Chemists Society.** Volume 62. February, 1985.

Devendra, C., S.W. Yeong, and H.K. Ong. "The Potential Value of Palm Oil Mill Effluent (POME) as a Feed Source for Farm Animals in Malaysia." **Proceedings of National Workshop on Oil Palm By-product Utilization.** 1981.

Quah, S.K. and D. Gilles. "Practical Experience in Production and Use of Biogas." **Proceedings of National Workshop on Oil Palm By-product Utilization.** 1981.

Tam, Tik, Mohd. Hashim Tajudin, and K.H. Yeow. "Land Application Techniques for Oil Mill By-products - Effluent and Bunch Ash." **Proceedings of National Workshop on Oil Palm By-product Utilization.** 1981.

Tah, P.Y., Y.C. Poon, and K.H. Yeow. "Bunch Ash as a Nutrient Source in Oil Palms." **Proceedings of National Workshop on Oil Palm By-product Utilization.** 1981.

Muthurajah, R.N. "Potential Chemical and Industrial Uses of Oil Palm Mill Bulk Waste." **Proceedings of National Workshop on Oil Palm By-product Utilization.** 1981.

Sutano, J. "Solvent Extraction Process to Achieve Zero-Effluent and to Produce Quality Animal Feed from Mill Sludge." **Proceedings of National Workshop on Oil Palm By-product Utilization**. 1981.

Ma, A.N., Cheah, S.C., and Chow, M.C. **Current Status on Treatment and Utilization of Palm Oil Industrial Wastes in Malaysia**. Palm Oil Research Institute of Malaysia (PORIM). Kuala Lumpur, Malaysia. 1989.

Plant Research and Development. A Biannual Collection of Recent German Contributions Concerning Development Through Plant Research. Vol. 32. Edited by the Institute for Scientific Cooperation in conjunction with the Federal Research Centre for Forestry and Forest Products and numerous members of German universities.

Edewor, J.O. "A Comparison of Treatment Methods for Palm Oil Mill Effluent (POME) Wastes." **Journal of Chemical Technology and Biotechnology**. Volume 36. May, 1986.

Yeow, K.H. and Zin Zakaria. **MOPGC/PORIM Progress Report on Palm Oil Raw Effluent Utilization**. Proceedings of National Workshop on Oil Palm By-Product Utilization/Organized by Palm Oil Research Institute of Malaysian Oil Palm Growers' Council. 1981.

T.S. Tang and P.K. Teoh. "Palm Kernel Oil Extraction - The Malaysian Experience." **Journal of American Oil Chemists Society**. Volume 62. February, 1985.

**Energy and Material Analysis on Palm Kernel Oil Extraction by Mechanical Pressing**. Dalex Sdn. Bhd. 1989.

Deffense, E. "Fractionation of Palm Oil." **Journal of American Oil Chemists Society**. Volume 62. February, 1985.

Chemical profiles information taken from the website:

<http://www.the-innovation-group.com/welcome.htm>

Flowchart in International News on Fats and Oils and Related Materials (Inform). Volume 1(12). 1990.

## **PRODUCTION OF METHYLENE DIPHENYLENE DIISOCYANATE (MDI)**

**The Resin Review. The Annual Statistical Report for the U.S. Plastics Industry**. American Plastics Council. 2003.

**Reigel's Handbook of Industrial Chemistry**. Tenth Edition. Edited by James A. Kent. Kluwar Academic / Plenum Publishers. New York. 2003.

**Compilation of Air Pollutant Emission Factors, Volume I: Stationary Point and Area Sources.** Fifth Edition. U.S. Environmental Protection Agency. July 1995.

Franklin Associates estimate.

Information and data collected from APC member and non-member companies producing nitrobenzene and aniline. 2003-2004.

Chemical profiles information taken from the website:

<http://www.the-innovation-group.com/welcome.htm>

Information and data collected from APC member and non-member companies producing phosgene, MDA, and PMDI/MDI. 2003.

Isocyanates information compiled from the website:

<http://www.levitt-safety.com/WhatsNew/DesignatedSubstances/isocyanates.htm>

Information and data collected from a confidential source producing formaldehyde. 2007.

Information and data collected from a confidential source producing nitric acid. 1990.

## **PRODUCTION OF TOLUENE DIISOCYANATE (TDI)**

**The Resin Review. The Annual Statistical Report for the U.S. Plastics Industry.** American Plastics Council. 2003.

Chemical profiles information taken from the website:

<http://www.the-innovation-group.com/welcome.htm>

Data compiled by Franklin Associates, Ltd., based on contact with confidential catalytic reforming sources. 1992.

Transportation information taken from the website:

<http://ascension-caer.org/airproducts.htm>

Franklin Associates estimate.

Distances calculated using the websites: <http://www.indo.com/distance/> and <http://www.mapquest.com/>

**Hydrocarbon Processing.** "1979 Petrochemical Handbook." November, 1979.

Polyurethane 102, Polyurethane Chemistry and Raw Materials. Slides and notes from the Polyurethane Professional Development Program produced by the Alliance for the Polyurethanes Industry. 2003 edition.

**Reigel's Handbook of Industrial Chemistry.** Tenth Edition. Edited by James A. Kent. Kluwar Academic / Plenum Publishers. New York. 2003.

Information and data collected from APC member and non-member companies producing phosgene, DNT, TDA, and TDI. 2003 and 2009.

U.S. Bureau of Mines. **Minerals Yearbook. Sulfur. 2005.**

**Reigel's Handbook of Industrial Chemistry.** Tenth Edition. Edited by James A. Kent. Kluwar Academic / Plenum Publishers. New York. 2003.

Data compiled by Franklin Associates based on contact with confidential sources. 1991.

Gary, James H. and Glenn E. Handwerk. Petroleum Refining - Technology and Economics. Marcel Dekker, Inc. 2001.

Gary, James H. and Glenn E. Handwerk. **Petroleum Refining- Technology and Economics.** Marcel Dekker, Inc. 1984.

Based on assumptions by Franklin Associates.

Ober, J.A., **Sulfur.** US Geological Survey. Minerals Yearbook 2004.

EPA AP-42: Inorganic Chemical Industry, Sulfuric Acid. 1993.

Data developed by Franklin Associates, Ltd., based on confidential information supplied by industry sources. 1992 and 2002.

U.S. Department of Energy Office of Energy Efficiency and Renewable Energy. Energy and Environmental Profile of the U.S. Mining Industry. Chapter 3: Potash, Soda Ash, and Borates. December 2002.

Transportation data averaged from data provided by all pulp mills. 2008.

Fuel Oil Use in Manufacturing. U.S. Department of Energy, Energy Information Administration. 1994.

U.S. Bureau of Mines. **Minerals Yearbook, 2002.**



## GLOSSARY

### TERMS USED IN THE LCI REPORT AND APPENDICES

**Biochemical Oxygen Demand (BOD).** An indication of the amount of organic material present in water or wastewater.

**Biomass.** The total dry organic matter or stored energy content of living organisms that is present at a specific time in a defined unit of the Earth's surface. As an energy source, the Energy Information Administration defines biomass as organic non-fossil material of biological origin constituting a renewable energy source.

**Btu (British thermal unit).** A standard unit for measuring the quantity of heat energy equal to the quantity of heat required to raise the temperature of 1 pound of water by 1 degree Fahrenheit.

**Carbon Cycle, Natural.** The process by which carbon dioxide is taken up by trees and released at a later time when these trees, or products made from them, decompose or are burned. The U.S. EPA uses the convention that carbon dioxide releases from wood-derived materials do not constitute a net contribution to global carbon dioxide, because the carbon dioxide removed from the atmosphere during the trees' growth cycle is simply being returned to the atmosphere.

**Carbon Dioxide Equivalent.** A greenhouse gas's potential to contribute to global warming, relative to carbon dioxide, which is assigned a global warming potential of 1.

**Carbon Dioxide.** A naturally occurring gas and also a by-product of burning fossil fuels and biomass, as well as land-use changes and other industrial processes. It is the principal anthropogenic greenhouse gas that affects the Earth's radiative balance. It is the reference gas against which other greenhouse gases are measured and therefore has a Global Warming Potential of 1<sup>7</sup>.

**Carbon Dioxide, Fossil.** Carbon dioxide associated with the combustion of fossil fuels.

**Carbon Dioxide, Non-fossil.** Carbon dioxide associated with natural sources or combustion of biomass.

**Chemical Oxygen Demand (COD).** The amount of oxygen required for the oxidation of compounds in water, as determined by a strong oxidant such as dichromate.

---

<sup>7</sup> Definition from the glossary of the Intergovernmental Panel on Climate Change (IPCC) Third Assessment Report - **Climate Change 2001**.

**Coal.** A black or brownish-black solid, combustible substance formed by the partial decomposition of vegetable matter without access to air. The rank of coal, which includes anthracite, bituminous coal, subbituminous coal, and lignite, is based on fixed carbon, volatile matter, and heating value. Coal rank indicates the progressive alteration, or coalification, from lignite to anthracite.

**Combustion Energy.** The high heat value directly released when coal, fuel oil, natural gas, or wood are burned for energy consumption.

**Combustion Emissions.** The environmental emissions directly emitted when coal, fuel oil, natural gas, or wood are burned for energy consumption.

**Crude Oil.** A mixture of hydrocarbons that exists in liquid phase in underground reservoirs and remains liquid at atmospheric pressure after passing through surface separating facilities.

**Curie (Ci).** The metric unit of radioactive decay. The quantity of any radioactive nuclide that undergoes  $3.7 \times 10^{10}$  disintegrations/sec.

**Distillate Fuel Oil.** A general classification for one of the petroleum fractions produced in conventional distillation operations. It is used primarily for space heating, on-and off-highway diesel engine fuel (including railroad engine fuel and fuel for agricultural machinery), and electric power generation. Included are products known as No. 1, No. 2, and No. 4 diesel fuels.

**Energy of Material Resource.** The energy value of fuel resources withdrawn from the planet's finite fossil reserves and used as material inputs for materials such as plastic resins. Alternative terms used by other LCI practitioners include "Feedstock Energy" and "Inherent Energy."

**Fossil Fuel.** Carbon-based fuel from fossil carbon deposits such as oil, natural gas, and coal.

**Fuel-related Emissions.** Emissions (atmospheric, waterborne, and solid waste) associated with the combustion of fuel, including carbon dioxide emissions, products of incomplete combustion, residual ash, etc.

**Fugitive Emissions.** Unintended leaks of substances that escape to the environment without treatment. These are typically from the processing, transmission, and/or transportation of fossil fuels, but may also include leaks and spills from reaction vessels, other chemical processes, etc.

**Geothermal Energy.** Energy from the internal heat of the earth, which may be residual heat, friction heat, or a result of radioactive decay. The heat is found in rocks and fluids at various depths and can be extracted by drilling and/or pumping.

**Global Warming Potential (GWP).** An index, describing the radiative characteristics of well-mixed greenhouse gases, that represents the combined effect of the differing times these gases remain in the atmosphere and their relative effectiveness in absorbing outgoing infrared radiation. This index approximates the time-integrated warming effect of a unit mass of a given greenhouse gas in today's atmosphere, relative to that of carbon dioxide<sup>8</sup>.

**Greenhouse Effect.** The entrapment of heat within the Earth's surface-troposphere system due to the absorption of infrared radiation by greenhouse gases<sup>9</sup>.

**Greenhouse Gas.** Greenhouse gases are those gaseous constituents of the atmosphere, both natural and anthropogenic, that absorb and emit radiation at specific wavelengths within the spectrum of infrared radiation emitted by the Earth's surface, the atmosphere, and clouds. This property causes the greenhouse effect. Water vapor, carbon dioxide, nitrous oxide, methane, and ozone are the primary greenhouse gases in the Earth's atmosphere<sup>10</sup>.

**Heat Content of a Quantity of Fuel, Gross.** The total amount of heat released when a fuel is burned. Coal, crude oil, and natural gas all include chemical compounds of carbon and hydrogen. When those fuels are burned, the carbon and hydrogen combine with oxygen in the air to produce carbon dioxide and water. Some of the energy released in burning goes into transforming the water into steam and is usually lost. The amount of heat spent in transforming the water into steam is counted as part of gross heat but is not counted as part of net content. Also referred to as the higher heating value. Btu conversion factors typically used by EIA represent gross heat content. Called combustion energy in this appendix.

**Heat Content of a Quantity of Fuel, Net.** The amount of usable heat energy released when a fuel is burned under conditions similar to those in which it is normally used. Also referred to as the lower heating value. Btu conversion factors typically used by EIA represent gross heat content.

**Hydrocarbons.** A subcategory of organic compounds that contain only hydrogen and carbon. These compounds may exist in either the gaseous, liquid, or solid phase, and have a molecular structure that varies from the simple to the very heavy and very complex. The category Non-Methane Hydrocarbons (NMHC) is sometimes used when methane is reported separately.

**Liquefied Petroleum Gases (LPG).** Ethane, ethylene, propane, propylene, normal butane, butylene, isobutane, and isobutylene produced at refineries or natural gas processing plants, including plants that fractionate raw natural gas plant liquids.

---

<sup>8</sup> Definition from the glossary of the Intergovernmental Panel on Climate Change (IPCC) Third Assessment Report - **Climate Change 2001**.

<sup>9</sup> Adapted from the definition in the glossary of the Intergovernmental Panel on Climate Change (IPCC) Third Assessment Report - **Climate Change 2001**.

<sup>10</sup> Partial definition for this term from the glossary of the Intergovernmental Panel on Climate Change (IPCC) Third Assessment Report - **Climate Change 2001**.

**Methane (CH<sub>4</sub>).** A hydrocarbon that is a greenhouse gas produced through anaerobic (without oxygen) decomposition of waste in landfills, animal digestion, decomposition of animal wastes, production and distribution of natural gas and oil, coal production, and incomplete fossil fuel combustion<sup>11</sup>. Methane is the principal constituent of natural gas.

**(Motor) Gasoline.** A complex mixture of relatively volatile hydrocarbons, with or without small quantities of additives, that has been blended to form a fuel suitable for use in spark-ignition engines. “Motor gasoline” includes reformulated gasoline, oxygenated gasoline, and other finished gasoline.

**Natural Gas.** A mixture of hydrocarbons (principally methane) and small quantities of various nonhydrocarbons existing in the gaseous phase or in solution with crude oil in underground reservoirs.

**Nitrogen Oxides (NO<sub>x</sub>).** Compounds of nitrogen and oxygen produced by the burning of fossil fuels, or any other combustion process taking place in air. The two most important oxides in this category are nitrogen oxide (NO) and nitrogen dioxide (NO<sub>2</sub>). Nitrous oxide (N<sub>2</sub>O), however, is not included in this category and is considered separately.

**Nitrous Oxide (N<sub>2</sub>O).** A greenhouse gas emitted through soil cultivation practices, especially the use of commercial and organic fertilizers, fossil fuel combustion, nitric acid production, and biomass burning<sup>12</sup>.

**Non-Methane Volatile Organic Compounds (NMVOC).** Organic compounds, other than methane, that participate in atmospheric photochemical reactions.

**Other Organics.** Compounds containing carbon combined with hydrogen and other elements such as oxygen, nitrogen, sulfur or others. Compounds containing only carbon and hydrogen are classified as hydrocarbons and are not included in this category.

**Particulate Matter (Particulates).** Small solid particles or liquid droplets suspended in the atmosphere, ranging in size from 0.005 to 500 microns.

Particulates are usually characterized as primary or secondary. Primary particulates, usually 0.1 to 20 microns in size, are those injected directly into the atmosphere by chemical or physical processes. Secondary particulates are produced as a result of chemical reactions that take place in the atmosphere. In our reports, particulates refer only to primary particulates.

---

<sup>11</sup> Adapted from the definition in the glossary of the Intergovernmental Panel on Climate Change (IPCC) Third Assessment Report - **Climate Change 2001**.

<sup>12</sup> Adapted from the definition in the glossary of the Intergovernmental Panel on Climate Change (IPCC) Third Assessment Report - **Climate Change 2001**.

Particulates reported by Franklin Associates are not limited by size range, and are sometimes called total suspended particulates (TSP). The category PM-10 refers to all particulates less than 10 microns in (aerodynamic) diameter. This classification is sometimes used when health effects are being considered, since the human nasal passages will filter and reject any particles larger than 10 microns. PM 2.5 (less than 2.5 microns in diameter) is now considered the size range of most concern for human health effects.

**Petroleum.** A generic term applied to oil and oil products in all forms, such as crude oil, lease condensate, unfinished oils, petroleum products, natural gas plant liquids, and nonhydrocarbon compounds blended into finished petroleum products.

**Postconsumer Waste.** Product or material that has served its intended use and is discarded by the consumer.

**Precombustion Energy.** The energy required for the production and processing of energy fuels, such as coal, fuel oil, natural gas, or uranium, starting with their extraction from the ground, up to the point of delivery to the customer.

**Precombustion Fuel-related Emissions.** The environmental emissions due to the combustion of fuels used in the production and processing of the primary fuels; coal, fuel oil, natural gas, and uranium.

**Precombustion Process Emissions.** The environmental emissions due to the production and processing of the primary fuels; coal, fuel oil, natural gas, and uranium, that are process rather than fuel-related emissions.

**Process Emissions.** Emissions (atmospheric, waterborne, and solid waste) that result from a process, such as gases given off during a chemical reaction, residual material remaining in the bottom of a reaction vessel, unrecycled trim scrap from fabrication processes, etc.

**Process Energy.** Energy used for any/all processes that extract, transform, fabricate or otherwise effect changes on a material or product during its life cycle.

**Residual Fuel Oil.** The heavier oils that remain after the distillate fuel oils and lighter hydrocarbons are distilled away in refinery operations. Included are No. 5, No. 6, and Navy Special. It is used for commercial and industrial heating, electricity generation, and to power ships.

**Sulfur Oxides (SO<sub>x</sub>).** Compounds of sulfur and oxygen, such as sulfur dioxide (SO<sub>2</sub>) and sulfur trioxide (SO<sub>3</sub>).

**Total Dissolved Solids (TDS).** The TDS in water consists of inorganic salts, minute organic particles, and dissolved materials. In natural waters, salts are chemical compounds composed of anions such as carbonates, chlorides, sulfates, and nitrates, and cations such as potassium, magnesium, calcium, and sodium.

**Total Suspended Solids (TSS).** TSS gives a measure of the turbidity of the water. Suspended solids cause the water to be milky or muddy looking due to the light scattering from very small particles in the water.

**Transportation Energy.** The energy used to move materials or products from location to location during the journey from raw material extraction through end of life disposition.

**Volatile Organic Compounds (VOCs).** Organic compounds that participate in atmospheric chemical reactions.